



CAMSHELVING[®]

Product Specification Guide-North America

S H E L V I N G f o r L I F E[®]

CAMBRO[®]
TRUSTED DURABILITY

www.cambro.com

TABLE of CONTENTS

Space Planning Quick Guides	PAGE
Overall Footprint Guide	4-5
Shelf Storage Planning Guide	6-7
Camshelving® Premium Series	
General Specs, Sizes and Weight Bearing	8-9
Stationary Starter and Add-on Units	10-13
Mobile Starter Units	14
High Density Mobile Units	15
High Density Tracks, Extension Kits, Floor Fastener	16
Post and Shelf Kits	17-20
Corner Connectors, Dunnage Stands, Traverses	21
Camshelving® Elements XTRA Series	
General Specs, Sizes and Weight Bearing	22-23
Stationary Starter and Add-on Units	24-30
Mobile Starter Units	31
High Density Mobile Units	32
High Density Tracks, Extension Kits, Floor Fastener	33
Post Kits and Shelf Kits	34-37
Corner Connectors, Dunnage Stands, Traverses	38
Camshelving® Basics Plus Series	
General Specs, Sizes and Weight Bearing	40-41
Stationary Starter and Add-on Units	42-48
Post Kits and Shelf Kits	49-52
Corner Connectors, Dunnage Stands, Traverses	53
Optional Accessories	
Unit/Shelf Storage Stabilizers	
Shelf Rail Kits	54
Wall and Floor Fasteners	55
Shelf Storage Maximizers	
Universal Storage Rack	56
Ultimate Sheet Pan Rack for Single Shelf	57
Shelf Storage Organizers	
Shelf ID Tags	57
Divider Bars	57
Shelf Divider Panel	57
Utility Shelving Products	
Ultimate Food Pan Trolleys and Sheet Pan Racks	58-60
Premium® Series Drying and Storage Racks	61-63
Security Cages and Units	64
Premium and Elements XTRA Can Racks	66-67
Premium Series Flex Stations	68-69
Elements® XTRA Series Undercounter Units	69
Wall Shelving and Dunnage Racks	70
Replacements Parts	71-74



MAXIMIZED SPACE UTILIZATION

Components have been thoughtfully designed to maximize storage space, even in space-restricted areas. Position shelves anywhere along the post, with dovetails spaced 4" apart.

● = Corner Connectors

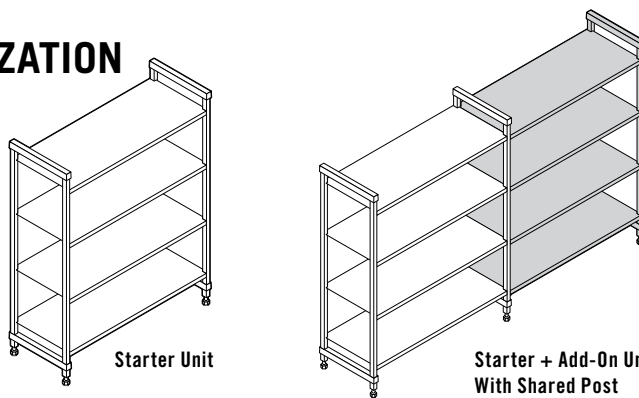

Shared Post
Space is money. Shelving units are designed to be interconnected, without compromising weight-bearing capacity all while maximizing usable storage space.

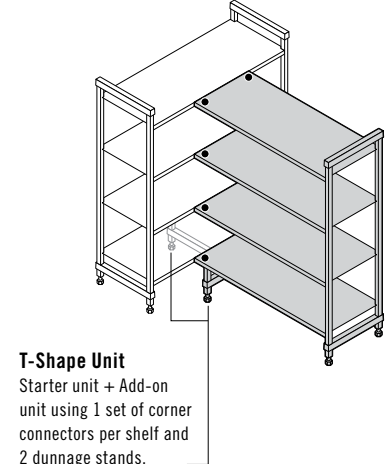
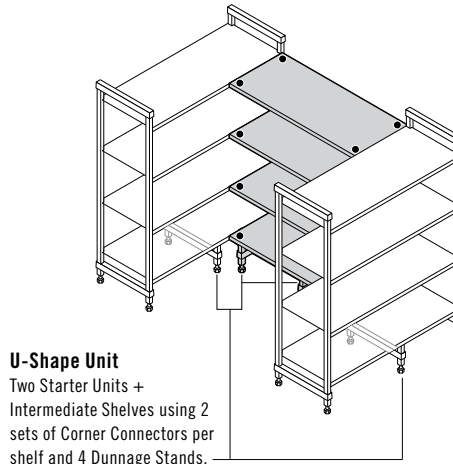
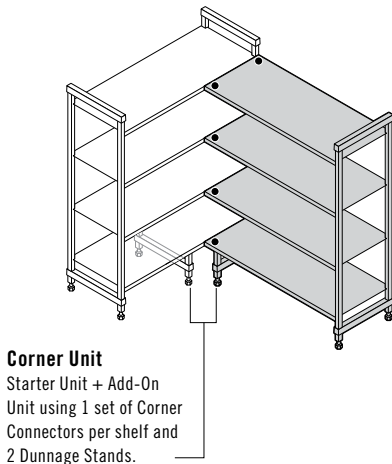

Corner Connectors

Convert unusable space into continuous, easy-access storage areas using corner connectors. (Corner connectors are for use only with shelves 24" - 48" long.) Up to 60" long for Elements XTRA only.

Camshelving is covered under the following US Patents:

D498,664 S, D508,646 S, D512,867 S, D623,929 S, D624,764 S, D648,582 S, D630,935 S, D648,159 S, D651,433 S, D648,160 S, D697,391 S, D727,715 S, D728,347 S, D728,348 S, D707,994 S, D739,989 S, D663,912 S, D736,488 S, D739,989 S, US 6,981,454B2, D760,519 S.

FREE CAMSHELVING® DESIGN SERVICE

Take the guesswork out of creating your perfect shelving layout. Let our in-house expert shelving consultants prepare a free layout that optimizes your space to create the most storage options.

Here's what you'll get:

- 2D Floor Plan
- 3D Floor Plan
- Itemized product list by room/area
- All within 48 business-day hours

It's Simple! To Get Started, Please Provide:

- Project Name
- Storage Room Type
freezer/cooler/dry storage
- Room(s) Dimensions (L x W x H)
- Doorway / Entryway Location & Dimension
- Obstructions (condenser / pipes)
- Additional Preferences / Requirements

Need help or have questions?

Contact Customer Service or Email shelving@cambro.com. Call Toll-Free (877)-737-0663

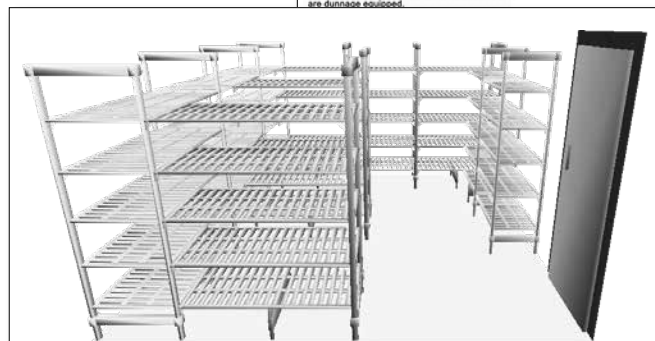
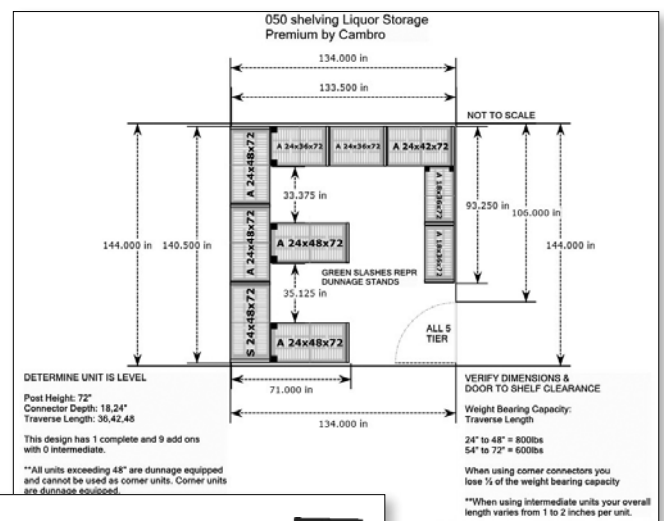

SCAN HERE



Request a Free Shelving Layout

FOOTPRINT/SPACE REFERENCE GUIDE

Straight Unit: Starter Unit + Add-On Unit with Shared Posts

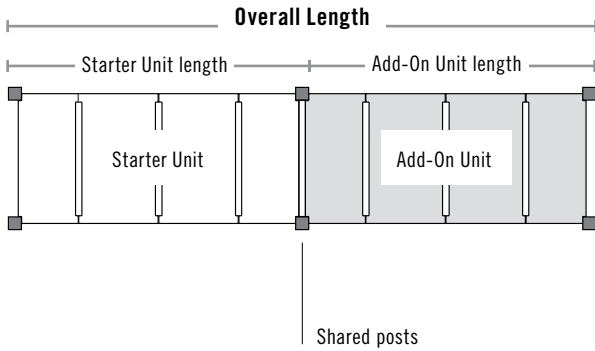

PREMIUM® / BASICS PLUS® SERIES

STARTER & ADD-ON UNIT	STARTER UNIT ACTUAL LENGTH		ADD-ON UNIT ACTUAL LENGTH		OVERALL LENGTH
24"*	24"	+	22¼"	=	46¼"
30"	30"	+	28¼"	=	58¼"
36"	36"	+	34¼"	=	70¼"
42"	42"	+	40¼"	=	82¼"
48"	48"	+	46¼"	=	94¼"
54"	54"	+	52¼"	=	106¼"
60"	60"	+	58¼"	=	118¼"
72"*	72"	+	70¼"	=	142¼"

*24" and 72" are not available in Camshelving Basics Plus Series.

Corner Unit: Starter Unit + Add-On Unit with Corner Connectors

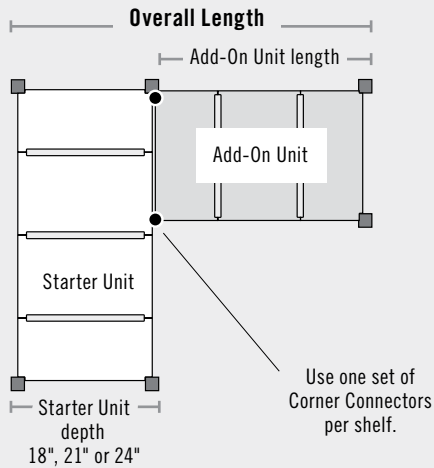

PREMIUM / ELEMENTS XTRA / BASICS PLUS SERIES

ADD-ON UNIT	ADD-ON UNIT ACTUAL LENGTH		18" STARTER UNIT DEPTH		OVERALL LENGTH
24"	23"	+	18"**	=	41"
30"	29"	+	18"	=	47"
36"	35"	+	18"	=	53"
42"	41"	+	18"	=	59"
48"	47"	+	18"	=	65"
54"*	53"	+	18"	=	71"
60"*	59"	+	18"	=	77"

NOTE: 24" unit not available in Camshelving Basics Plus Series.
*Elements XTRA Series only **Actual depth.

U-Shape Unit: Two Starter Units + Middle Shelf Kits attached with with Corner Connectors

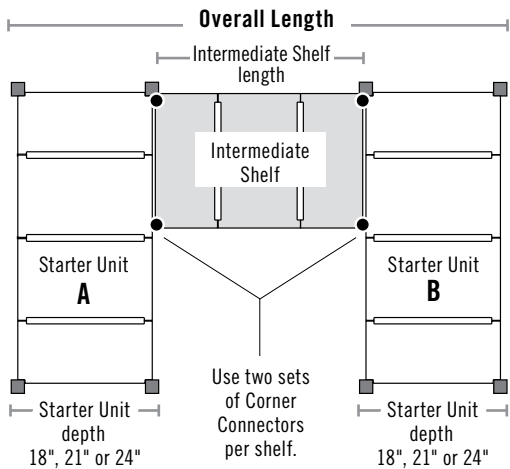

PREMIUM / ELEMENTS XTRA / BASICS PLUS SERIES

INTERMEDIATE SHELF	INTERMEDIATE SHELF ACTUAL LENGTH		18" DEPTH STARTER UNIT A+B		OVERALL LENGTH
36"	34"	+	36"**	=	70"
42"	40"	+	36"	=	76"
48"	46"	+	36"	=	82"
54"*	52"	+	36"	=	88"
60"*	58"	+	36"	=	94"

*Elements XTRA Series only **Actual depth.

ELEMENTS® XTRA SERIES

STARTER UNIT ACTUAL LENGTH		ADD-ON UNIT ACTUAL LENGTH		OVERALL LENGTH
24"	+	22"	=	46"
30"	+	28"	=	58"
36"	+	34"	=	70"
42"	+	40"	=	82"
48"	+	46"	=	94"
54"	+	52"	=	106"
60"	+	58"	=	118"
72"	+	70"	=	142"

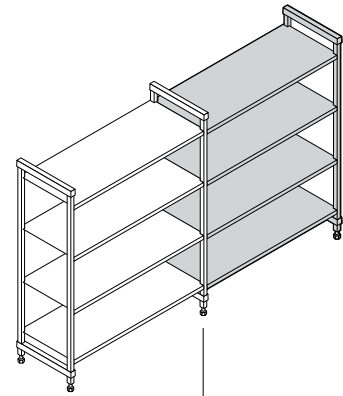

Shared posts

PREMIUM / ELEMENTS XTRA / BASICS PLUS SERIES

ADD-ON UNIT ACTUAL LENGTH		21" STARTER UNIT DEPTH		OVERALL LENGTH
23"	+	21"***	=	44"
29"	+	21"	=	50"
35"	+	21"	=	56"
41"	+	21"	=	62"
47"	+	21"	=	68"
53"	+	21"	=	74"
59"	+	21"	=	80"

PREMIUM / ELEMENTS XTRA / BASICS PLUS SERIES

ADD-ON UNIT ACTUAL LENGTH		24" STARTER UNIT DEPTH		OVERALL LENGTH
23"	+	24"***	=	47"
29"	+	24"	=	53"
35"	+	24"	=	59"
41"	+	24"	=	65"
47"	+	24"	=	71"
53"	+	24"	=	77"
59"	+	24"	=	83"

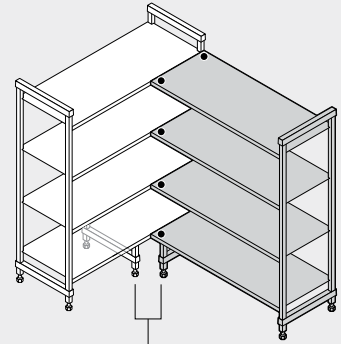

Use One Dunnage Stand under each Starter and Add-On Unit.

Corner Connectors are for use only with shelves 24"- 48" long. Up to 60" long for Elements XTRA Series only.

• = Corner Connectors

PREMIUM / ELEMENTS XTRA / BASICS PLUS SERIES

INTERMEDIATE SHELF ACTUAL LENGTH		21" DEPTH STARTER UNIT A+B		OVERALL LENGTH
34"	+	42"***	=	76"
40"	+	42"	=	82"
46"	+	42"	=	88"
52"	+	42"	=	94"
60"	+	42"	=	102"

PREMIUM / ELEMENTS XTRA / BASICS PLUS SERIES

INTERMEDIATE SHELF ACTUAL LENGTH		24" DEPTH STARTER UNIT A+B		OVERALL LENGTH
34"	+	48"***	=	82"
40"	+	48"	=	88"
46"	+	48"	=	94"
52"	+	48"	=	100"
60"	+	48"	=	108"

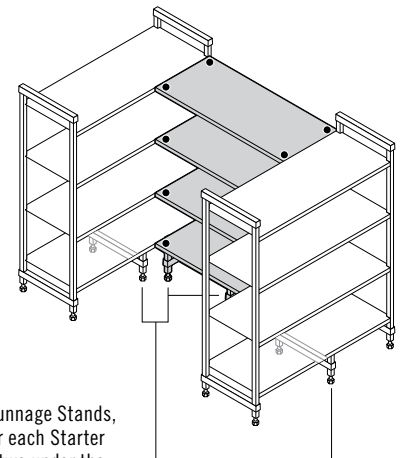

Use four Dunnage Stands, one under each Starter Unit and two under the bottom middle Shelf.

• = Corner Connectors

SHELF STORAGE PLANNING GUIDE

Use this guide to determine available storage space between posts based on shelf length AND where to install shelves based on height of the product (s) stored on each shelf.

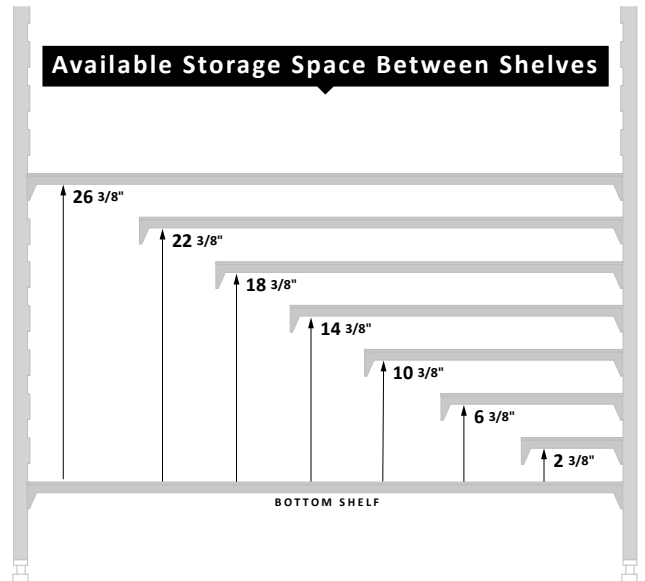
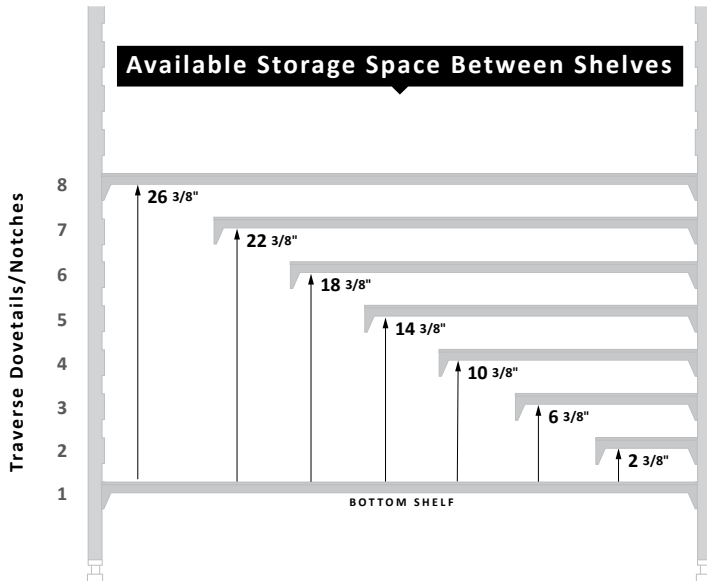
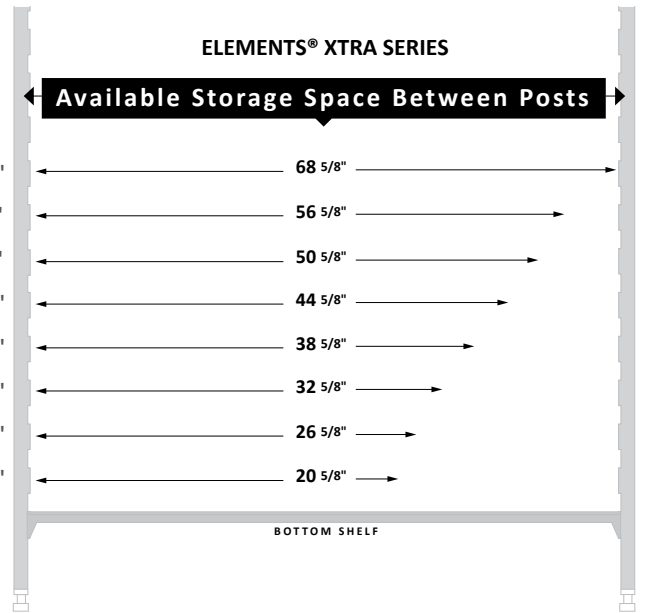
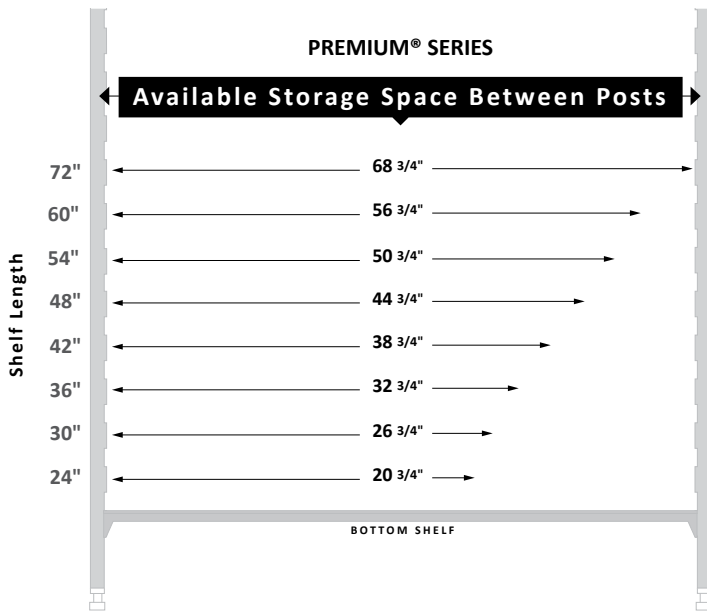

BASICS® PLUS SERIES

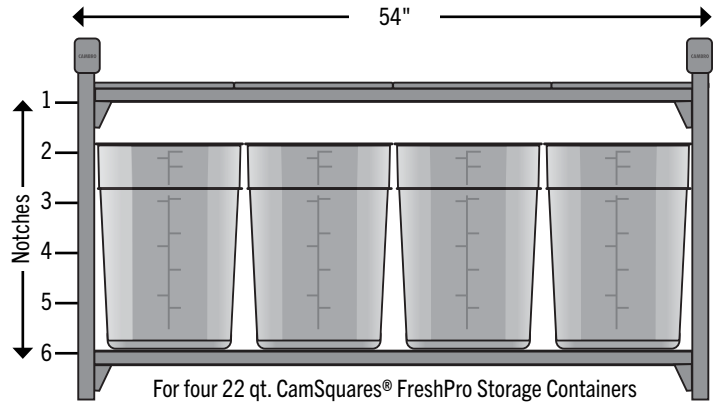
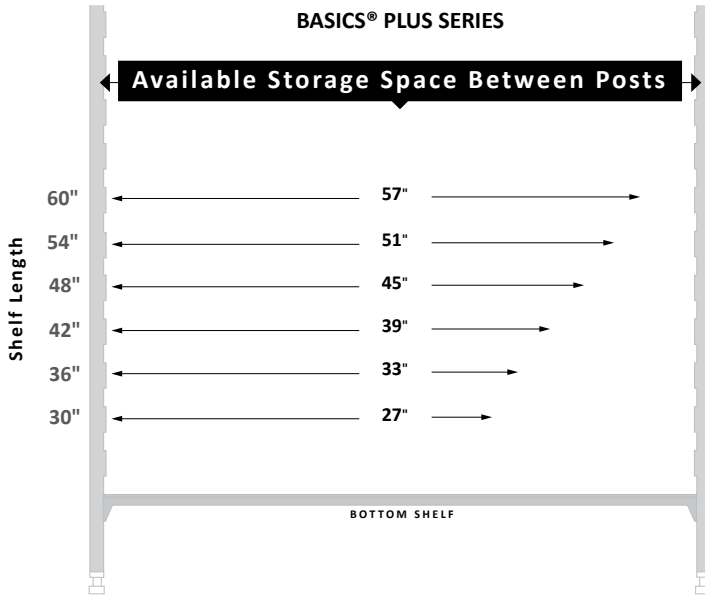

For four 22 qt. CamSquares® FreshPro Storage Containers

Maximum Number of Shelves per Unit

POST HEIGHT	# of Shelves*
STATIONARY UNIT	
30"	5
32"	6
56"	12
64"	14
72"	16
84"	19
MOBILE UNIT	
27¼"	3
69" or 70¼"	14
75" or 78¼"	16

*Based on number of molded-in shelf traverse dovetail notches.

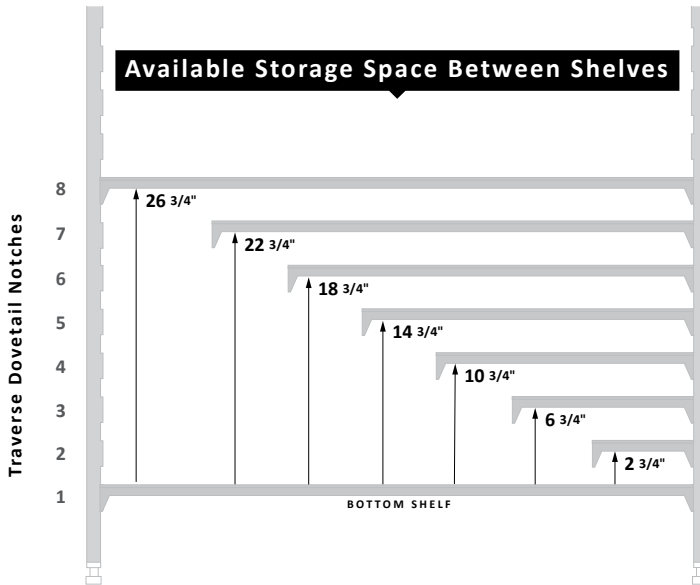

Molded-in Traverse Dovetails

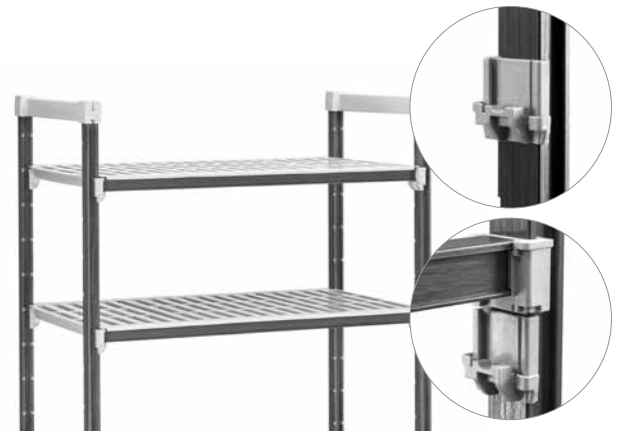

Traverse Dovetail Notches

CAMSHELVING

PREMIUM[®]

series

STATIONARY | MOBILE | HIGH DENSITY

- Posts and traverses have a steel core and smooth polypropylene exterior for superior strength and durability.
- Traverse dovetails are molded into posts every 4".
- Polypropylene shelf plates with permanent, molded-in Camguard[®], an antimicrobial technology that inhibits the growth of mold, fungus, and bacteria.
- Sturdy reinforced threaded nylon foot adjusts easily to level units.
- Withstands storage temperatures from -36°F to 190°F.
- Lifetime warranty against rust and corrosion.



camguard
ANTIMICROBIAL SHELF PLATES



COMPONENT

Post Connectors, Corner Connectors, Floor Fastener, Wall Fastener, Identification Tags, Full Wrap Security Cage, Single Shelf Security Cage, Ultimate #10 Can Rack, Shelf Rails, Shelf Divider Bars, High Density Track and Extension Kits are not NSF Listed.

STARTER UNITS

Ship complete in 1 box. Includes factory assembled post frames for quicker assembly.

*Units ship in separate post kit (unassembled) and shelf kit cartons due to overall weight.

**Sold Separately as shelf kits & post kits only.

Stationary

4 Depths		8 Lengths			5 Heights		
14 ^{**}	18"	24"	30"	36"	32"	56"	64"
21"	24"	42"	48"	54"	72"	84 ^{**}	
		60"	72 ^{**}				

Standard Mobile

3 Depths			3 Lengths			4 Heights		
18"	21"	24"	36"	42"	48"	35"	59"	67"
						75"		

High Density Mobile

3 Depths			5 Lengths			2 Heights	
18 ^{**}	21"	24"	36"	42"	48"	67"	75"
			54"	60"			

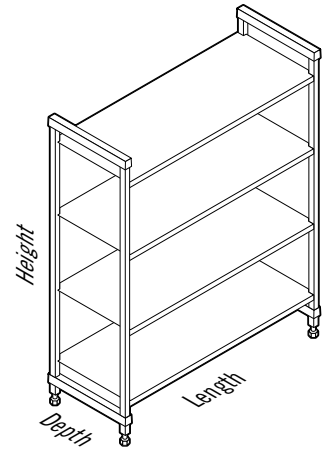

Weight Bearing Capacity

Weight must be evenly distributed across the entire shelf.

		UNIT LENGTH 24" – 48"	UNIT LENGTH 54" – 72"
SINGLE UNIT	Unit only	2,000 lbs.	2,000 lbs.
	Shelf only	800	600
	Unit with dunnage stand*	2,400	2,300
	Bottom shelf with dunnage stand*	1,200	900
CORNER UNIT*** With 2 Dunnage Stands required	Unit only	1,800	—
	Shelf only	400	—
	Bottom shelf with dunnage stands*	600	—
MOBILE UNIT	Unit only**	750	—

*Dunnage Stands add stability and increase weight bearing capacity on bottom shelf only. Highly recommended for Starter Units 54" and longer, all Corner Units, U-Shape Units and units specified for heavier loads. (See page 04-05).

**Due to the weight bearing capacity of casters, maximum weight load on an entire Mobile Unit is 750 lbs.

***Corner connectors are for use only with shelves 24" - 48" long.

PREMIUM®
SERIES



V4 4-Shelf Vented Units

V5 5-Shelf Vented Units

64"
HEIGHT

Starter units include 2 factory assembled post kits, 8 or 10 traverses and shelf plates.
Add-on units include 1 factory assembled post kit, 8 or 10 traverses and shelf plates. Units ship complete in 1 box.
Note: Units 72" in length ship in separate post kit (unassembled) and shelf kit cartons.

Starter

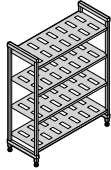

Add-On

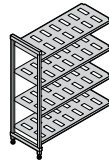

Starter

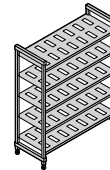

Add-On

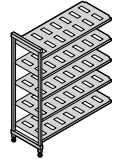

18"
DEPTH

LENGTH	CODE
24"	CPU182464V4
30"	CPU183064V4
36"	CPU183664V4
42"	CPU184264V4
48"	CPU184864V4
54"	CPU185464V4
60"	CPU186064V4
72"	CPU187264V4PKG

LENGTH	CODE
22¼"	CPA182464V4
28¾"	CPA183064V4
34¼"	CPA183664V4
40¼"	CPA184264V4
46¼"	CPA184864V4
52¼"	CPA185464V4
58¼"	CPA186064V4
70¼"	CPA187264V4PKG

LENGTH	CODE
24"	CPU182464V5
30"	CPU183064V5
36"	CPU183664V5
42"	CPU184264V5
48"	CPU184864V5
54"	CPU185464V5
60"	CPU186064V5
72"	CPU187264V5PKG

LENGTH	CODE
22¼"	CPA182464V5
28¾"	CPA183064V5
34¼"	CPA183664V5
40¼"	CPA184264V5
46¼"	CPA184864V5
52¼"	CPA185464V5
58¼"	CPA186064V5
70¼"	CPA187264V5PKG

21"
DEPTH

24"	CPU212464V4
30"	CPU213064V4
36"	CPU213664V4
42"	CPU214264V4
48"	CPU214864V4
54"	CPU215464V4
60"	CPU216064V4
72"	CPU217264V4PKG

22¼"	CPA212464V4
28¾"	CPA213064V4
34¼"	CPA213664V4
40¼"	CPA214264V4
46¼"	CPA214864V4
52¼"	CPA215464V4
58¼"	CPA216064V4
70¼"	CPA217264V4PKG

24"	CPU212464V5
30"	CPU213064V5
36"	CPU213664V5
42"	CPU214264V5
48"	CPU214864V5
54"	CPU215464V5
60"	CPU216064V5
72"	CPU217264V5PKG

22¼"	CPA212464V5
28¾"	CPA213064V5
34¼"	CPA213664V5
40¼"	CPA214264V5
46¼"	CPA214864V5
52¼"	CPA215464V5
58¼"	CPA216064V5
70¼"	CPA217264V5PKG

24"
DEPTH

24"	CPU242464V4
30"	CPU243064V4
36"	CPU243664V4
42"	CPU244264V4
48"	CPU244864V4
54"	CPU245464V4
60"	CPU246064V4
72"	CPU247264V4PKG

22¼"	CPA242464V4
28¾"	CPA243064V4
34¼"	CPA243664V4
40¼"	CPA244264V4
46¼"	CPA244864V4
52¼"	CPA245464V4
58¼"	CPA246064V4
70¼"	CPA247264V4PKG

24"	CPU242464V5
30"	CPU243064V5
36"	CPU243664V5
42"	CPU244264V5
48"	CPU244864V5
54"	CPU245464V5
60"	CPU246064V5
72"	CPU247264V5PKG

22¼"	CPA242464V5
28¾"	CPA243064V5
34¼"	CPA243664V5
40¼"	CPA244264V5
46¼"	CPA244864V5
52¼"	CPA245464V5
58¼"	CPA246064V5
70¼"	CPA247264V5PKG

Color: Speckled Gray (480).

S4 4-Shelf Solid Units

VS4 4-Shelf Units (3 Vented + 1 Solid)

64"
HEIGHT

Starter units include 2 factory assembled post kits, 8 traverses and shelf plates. Add-On units include 1 factory assembled post kit, 8 traverses and shelf plates. Units ship complete in 1 box. Install solid shelf on bottom to prevent water/cleaning solutions from sloshing up onto stored products. Install solid shelf on top to protect product stored on lower shelves from condensation in cooler.

Note: Units 72" in length ship in separate post kit (unassembled) and shelf kit cartons.

Starter

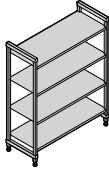

Add-On

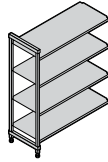

Starter

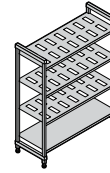

Add-On

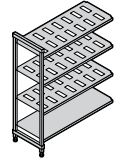

18"
DEPTH

LENGTH	CODE
24"	CPU182464S4
30"	CPU183064S4
36"	CPU183664S4
42"	CPU184264S4
48"	CPU184864S4
54"	CPU185464S4
60"	CPU186064S4
72"	CPU187264S4PKG

LENGTH	CODE
22¼"	CPA182464S4
28¾"	CPA183064S4
34¼"	CPA183664S4
40¼"	CPA184264S4
46¼"	CPA184864S4
52¼"	CPA185464S4
58¼"	CPA186064S4
70¼"	CPA187264S4PKG

LENGTH	CODE
24"	CPU182464VS4
30"	CPU183064VS4
36"	CPU183664VS4
42"	CPU184264VS4
48"	CPU184864VS4
54"	CPU185464VS4
60"	CPU186064VS4
72"	CPU187264VS4PKG

LENGTH	CODE
22¼"	CPA182464VS4
28¾"	CPA183064VS4
34¼"	CPA183664VS4
40¼"	CPA184264VS4
46¼"	CPA184864VS4
52¼"	CPA185464VS4
58¼"	CPA186064VS4
70¼"	CPA187264VS4PKG

21"
DEPTH

24"	CPU212464S4
30"	CPU213064S4
36"	CPU213664S4
42"	CPU214264S4
48"	CPU214864S4
54"	CPU215464S4
60"	CPU216064S4
72"	CPU217264S4PKG

22¼"	CPA212464S4
28¾"	CPA213064S4
34¼"	CPA213664S4
40¼"	CPA214264S4
46¼"	CPA214864S4
52¼"	CPA215464S4
58¼"	CPA216064S4
70¼"	CPA217264S4PKG

24"	CPU212464VS4
30"	CPU213064VS4
36"	CPU213664VS4
42"	CPU214264VS4
48"	CPU214864VS4
54"	CPU215464VS4
60"	CPU216064VS4
72"	CPU217264VS4PKG

22¼"	CPA212464VS4
28¾"	CPA213064VS4
34¼"	CPA213664VS4
40¼"	CPA214264VS4
46¼"	CPA214864VS4
52¼"	CPA215464VS4
58¼"	CPA216064VS4
70¼"	CPA217264VS4PKG

24"
DEPTH

24"	CPU242464S4
30"	CPU243064S4
36"	CPU243664S4
42"	CPU244264S4
48"	CPU244864S4
54"	CPU245464S4
60"	CPU246064S4
72"	CPU247264S4PKG

22¼"	CPA242464S4
28¾"	CPA243064S4
34¼"	CPA243664S4
40¼"	CPA244264S4
46¼"	CPA244864S4
52¼"	CPA245464S4
58¼"	CPA246064S4
70¼"	CPA247264S4PKG

24"	CPU242464VS4
30"	CPU243064VS4
36"	CPU243664VS4
42"	CPU244264VS4
48"	CPU244864VS4
54"	CPU245464VS4
60"	CPU246064VS4
72"	CPU247264VS4PKG

22¼"	CPA242464VS4
28¾"	CPA243064VS4
34¼"	CPA243664VS4
40¼"	CPA244264VS4
46¼"	CPA244864VS4
52¼"	CPA245464VS4
58¼"	CPA246064VS4
70¼"	CPA247264VS4PKG

V4 4-Shelf Vented Units

V5 5-Shelf Vented Units

72"
HEIGHT

Starter units include 2 factory assembled post kits, 8 or 10 traverses and shelf plates.
Add-on units include 1 factory assembled post kit, 8 or 10 traverses and shelf plates. Units ship complete in 1 box.
Note: Units 72" in length ship in separate post kit (unassembled) and shelf kit cartons.

Starter

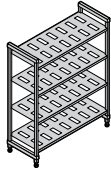

Add-On

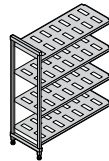

Starter

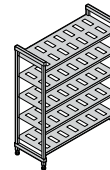

Add-On

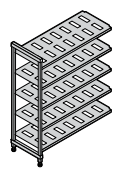

18"
DEPTH

LENGTH	CODE
24"	CPU182472V4
30"	CPU183072V4
36"	CPU183672V4
42"	CPU184272V4
48"	CPU184872V4
54"	CPU185472V4
60"	CPU186072V4
72"	CPU187272V4PKG

LENGTH	CODE
22¼"	CPA182472V4
28¾"	CPA183072V4
34¼"	CPA183672V4
40¼"	CPA184272V4
46¼"	CPA184872V4
52¼"	CPA185472V4
58¼"	CPA186072V4
70¼"	CPA187272V4PKG

LENGTH	CODE
24"	CPU182472V5
30"	CPU183072V5
36"	CPU183672V5
42"	CPU184272V5
48"	CPU184872V5
54"	CPU185472V5
60"	CPU186072V5
72"	CPU187272V5PKG

LENGTH	CODE
22¼"	CPA182472V5
28¾"	CPA183072V5
34¼"	CPA183672V5
40¼"	CPA184272V5
46¼"	CPA184872V5
52¼"	CPA185472V5
58¼"	CPA186072V5
70¼"	CPA187272V5PKG

21"
DEPTH

24"	CPU212472V4
30"	CPU213072V4
36"	CPU213672V4
42"	CPU214272V4
48"	CPU214872V4
54"	CPU215472V4
60"	CPU216072V4
72"	CPU217272V4PKG

22¼"	CPA212472V4
28¾"	CPA213072V4
34¼"	CPA213672V4
40¼"	CPA214272V4
46¼"	CPA214872V4
52¼"	CPA215472V4
58¼"	CPA216072V4
70¼"	CPA217272V4PKG

24"	CPU212472V5
30"	CPU213072V5
36"	CPU213672V5
42"	CPU214272V5
48"	CPU214872V5
54"	CPU215472V5
60"	CPU216072V5
72"	CPU217272V5PKG

22¼"	CPA212472V5
28¾"	CPA213072V5
34¼"	CPA213672V5
40¼"	CPA214272V5
46¼"	CPA214872V5
52¼"	CPA215472V5
58¼"	CPA216072V5
70¼"	CPA217272V5PKG

24"
DEPTH

24"	CPU242472V4
30"	CPU243072V4
36"	CPU243672V4
42"	CPU244272V4
48"	CPU244872V4
54"	CPU245472V4
60"	CPU246072V4
72"	CPU247272V4PKG

22¼"	CPA242472V4
28¾"	CPA243072V4
34¼"	CPA243672V4
40¼"	CPA244272V4
46¼"	CPA244872V4
52¼"	CPA245472V4
58¼"	CPA246072V4
70¼"	CPA247272V4PKG

24"	CPU242472V5
30"	CPU243072V5
36"	CPU243672V5
42"	CPU244272V5
48"	CPU244872V5
54"	CPU245472V5
60"	CPU246072V5
72"	CPU247272V5PKG

22¼"	CPA242472V5
28¾"	CPA243072V5
34¼"	CPA243672V5
40¼"	CPA244272V5
46¼"	CPA244872V5
52¼"	CPA245472V5
58¼"	CPA246072V5
70¼"	CPA247272V5PKG

Color: Speckled Gray (480).

S4 4-Shelf Solid Units

VS4 4-Shelf Units (3 Vented + 1 Solid)

72"
HEIGHT

Starter units include 2 factory assembled post kits, 8 traverses and shelf plates. Add-On units include 1 factory assembled post kit, 8 traverses and shelf plates. Units ship complete in 1 box. Install solid shelf on bottom to prevent water/cleaning solutions from sloshing up onto stored products. Install solid shelf on top to protect product stored on lower shelves from condensation in cooler.

Note: Units 72" in length ship in separate post kit (unassembled) and shelf kit cartons.

Starter

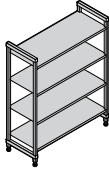

Add-On

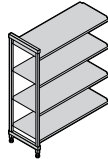

Starter

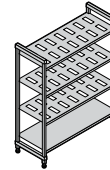

Add-On

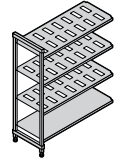

18"
DEPTH

LENGTH	CODE
24"	CPU182472S4
30"	CPU183072S4
36"	CPU183672S4
42"	CPU184272S4
48"	CPU184872S4
54"	CPU185472S4
60"	CPU186072S4
72"	CPU187272S4PKG

LENGTH	CODE
22¼"	CPA182472S4
28¾"	CPA183072S4
34¼"	CPA183672S4
40¼"	CPA184272S4
46¼"	CPA184872S4
52¼"	CPA185472S4
58¼"	CPA186072S4
70¼"	CPA187272S4PKG

LENGTH	CODE
24"	CPU182472VS4
30"	CPU183072VS4
36"	CPU183672VS4
42"	CPU184272VS4
48"	CPU184872VS4
54"	CPU185472VS4
60"	CPU186072VS4
72"	CPU187272VS4PKG

LENGTH	CODE
22¼"	CPA182472VS4
28¾"	CPA183072VS4
34¼"	CPA183672VS4
40¼"	CPA184272VS4
46¼"	CPA184872VS4
52¼"	CPA185472VS4
58¼"	CPA186072VS4
70¼"	CPA187272VS4PKG

21"
DEPTH

24"	CPU212472S4
30"	CPU213072S4
36"	CPU213672S4
42"	CPU214272S4
48"	CPU214872S4
54"	CPU215472S4
60"	CPU216072S4
72"	CPU217272S4PKG

22¼"	CPA212472S4
28¾"	CPA213072S4
34¼"	CPA213672S4
40¼"	CPA214272S4
46¼"	CPA214872S4
52¼"	CPA215472S4
58¼"	CPA216072S4
70¼"	CPA217272S4PKG

24"	CPU212472VS4
30"	CPU213072VS4
36"	CPU213672VS4
42"	CPU214272VS4
48"	CPU214872VS4
54"	CPU215472VS4
60"	CPU216072VS4
72"	CPU217272VS4PKG

22¼"	CPA212472VS4
28¾"	CPA213072VS4
34¼"	CPA213672VS4
40¼"	CPA214272VS4
46¼"	CPA214872VS4
52¼"	CPA215472VS4
58¼"	CPA216072VS4
70¼"	CPA217272VS4PKG

24"
DEPTH

24"	CPU242472S4
30"	CPU243072S4
36"	CPU243672S4
42"	CPU244272S4
48"	CPU244872S4
54"	CPU245472S4
60"	CPU246072S4
72"	CPU247272S4PKG

22¼"	CPA242472S4
28¾"	CPA243072S4
34¼"	CPA243672S4
40¼"	CPA244272S4
46¼"	CPA244872S4
52¼"	CPA245472S4
58¼"	CPA246072S4
70¼"	CPA247272S4PKG

24"	CPU242472VS4
30"	CPU243072VS4
36"	CPU243672VS4
42"	CPU244272VS4
48"	CPU244872VS4
54"	CPU245472VS4
60"	CPU246072VS4
72"	CPU247272VS4PKG

22¼"	CPA242472VS4
28¾"	CPA243072VS4
34¼"	CPA243672VS4
40¼"	CPA244272VS4
46¼"	CPA244872VS4
52¼"	CPA245472VS4
58¼"	CPA246072VS4
70¼"	CPA247272VS4PKG

V4PKG

4-Shelf Vented Stationary Starter and Add-On Units

V5PKG

5-Shelf Vented Stationary Starter and Add-On Units

84"
HEIGHT

Units ship in 2 or 3 separate boxes with 1 or 2 unassembled post kits and 1 box of 4 or 5 shelves.

Starter

Add-On

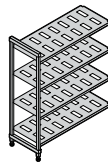
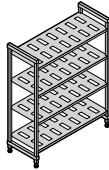

18"
DEPTH

LENGTH	CODE
24"	CPU182484V4PKG
30"	CPU183084V4PKG
36"	CPU183684V4PKG
42"	CPU184284V4PKG
48"	CPU184884V4PKG
54"	CPU185484V4PKG
60"	CPU186084V4PKG
72"	CPU187284V4PKG

LENGTH	CODE
22¼"	CPA182484V4PKG
28¾"	CPA183084V4PKG
34¼"	CPA183684V4PKG
40¼"	CPA184284V4PKG
46¼"	CPA184884V4PKG
52¼"	CPA185484V4PKG
58¾"	CPA186084V4PKG
70¼"	CPA187284V4PKG

Starter

Add-On

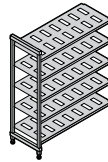
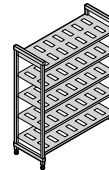

LENGTH	CODE
24"	CPU182484V5PKG
30"	CPU183084V5PKG
36"	CPU183684V5PKG
42"	CPU184284V5PKG
48"	CPU184884V5PKG
54"	CPU185484V5PKG
60"	CPU186084V5PKG
72"	CPU187284V5PKG

LENGTH	CODE
22¼"	CPA182484V5PKG
28¾"	CPA183084V5PKG
34¼"	CPA183684V5PKG
40¼"	CPA184284V5PKG
46¼"	CPA184884V5PKG
52¼"	CPA185484V5PKG
58¾"	CPA186084V5PKG
70¼"	CPA187284V5PKG

21"
DEPTH

24"	CPU212484V4PKG
30"	CPU213084V4PKG
36"	CPU213684V4PKG
42"	CPU214284V4PKG
48"	CPU214884V4PKG
54"	CPU215484V4PKG
60"	CPU216084V4PKG
72"	CPU217284V4PKG

22¼"	CPA212484V4PKG
28¾"	CPA213084V4PKG
34¼"	CPA213684V4PKG
40¼"	CPA214284V4PKG
46¼"	CPA214884V4PKG
52¼"	CPA215484V4PKG
58¾"	CPA216084V4PKG
70¼"	CPA217284V4PKG

24"	CPU212484V5PKG
30"	CPU213084V5PKG
36"	CPU213684V5PKG
42"	CPU214284V5PKG
48"	CPU214884V5PKG
54"	CPU215484V5PKG
60"	CPU216084V5PKG
72"	CPU217284V5PKG

22¼"	CPA212484V5PKG
28¾"	CPA213084V5PKG
34¼"	CPA213684V5PKG
40¼"	CPA214284V5PKG
46¼"	CPA214884V5PKG
52¼"	CPA215484V5PKG
58¾"	CPA216084V5PKG
70¼"	CPA217284V5PKG

24"
DEPTH

24"	CPU242484V4PKG
30"	CPU243084V4PKG
36"	CPU243684V4PKG
42"	CPU244284V4PKG
48"	CPU244884V4PKG
54"	CPU245484V4PKG
60"	CPU246084V4PKG
72"	CPU247284V4PKG

22¼"	CPA242484V4PKG
28¾"	CPA243084V4PKG
34¼"	CPA243684V4PKG
40¼"	CPA244284V4PKG
46¼"	CPA244884V4PKG
52¼"	CPA245484V4PKG
58¾"	CPA246084V4PKG
70¼"	CPA247284V4PKG

24"	CPU242484V5PKG
30"	CPU243084V5PKG
36"	CPU243684V5PKG
42"	CPU244284V5PKG
48"	CPU244884V5PKG
54"	CPU245484V5PKG
60"	CPU246084V5PKG
72"	CPU247284V5PKG

22¼"	CPA242484V5PKG
28¾"	CPA243084V5PKG
34¼"	CPA243684V5PKG
40¼"	CPA244284V5PKG
46¼"	CPA244884V5PKG
52¼"	CPA245484V5PKG
58¾"	CPA246084V5PKG
70¼"	CPA247284V5PKG

Color: Speckled Gray (480).

S4PKG

4-Shelf Solid Stationary Starter and Add-On Units

S5PKG

5-Shelf Solid Stationary Starter and Add-On Units

84"
HEIGHT

Units ship in 2 or 3 separate boxes with 1 or 2 unassembled post kits and
1 box of 4 or 5 shelves.

18"
DEPTH

Starter

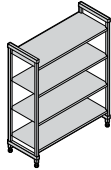

Add-On

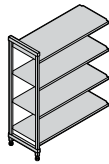

LENGTH	CODE
24"	CPU182484S4PKG
30"	CPU183084S4PKG
36"	CPU183684S4PKG
42"	CPU184284S4PKG
48"	CPU184884S4PKG
54"	CPU185484S4PKG
60"	CPU186084S4PKG
72"	CPU187284S4PKG

LENGTH	CODE
22¼"	CPA182484S4PKG
28¼"	CPA183084S4PKG
34¼"	CPA183684S4PKG
40¼"	CPA184284S4PKG
46¼"	CPA184884S4PKG
52¼"	CPA185484S4PKG
58¼"	CPA186084S4PKG
70¼"	CPA187284S4PKG

21"
DEPTH

24"	CPU212484S4PKG
30"	CPU213084S4PKG
36"	CPU213684S4PKG
42"	CPU214284S4PKG
48"	CPU214884S4PKG
54"	CPU215484S4PKG
60"	CPU216084S4PKG
72"	CPU217284S4PKG

22¼"	CPA212484S4PKG
28¼"	CPA213084S4PKG
34¼"	CPA213684S4PKG
40¼"	CPA214284S4PKG
46¼"	CPA214884S4PKG
52¼"	CPA215484S4PKG
58¼"	CPA216084S4PKG
70¼"	CPA217284S4PKG

24"
DEPTH

24"	CPU242484S4PKG
30"	CPU243084S4PKG
36"	CPU243684S4PKG
42"	CPU244284S4PKG
48"	CPU244884S4PKG
54"	CPU245484S4PKG
60"	CPU246084S4PKG
72"	CPU247284S4PKG

22¼"	CPA242484S4PKG
28¼"	CPA243084S4PKG
34¼"	CPA243684S4PKG
40¼"	CPA244284S4PKG
46¼"	CPA244884S4PKG
52¼"	CPA245484S4PKG
58¼"	CPA246084S4PKG
70¼"	CPA247284S4PKG

Starter

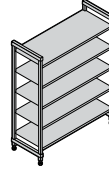

Add-On

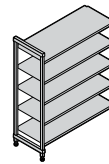

LENGTH	CODE
24"	CPU182484S5PKG
30"	CPU183084S5PKG
36"	CPU183684S5PKG
42"	CPU184284S5PKG
48"	CPU184884S5PKG
54"	CPU185484S5PKG
60"	CPU186084S5PKG
72"	CPU187284S5PKG

LENGTH	CODE
22¼"	CPA182484S5PKG
28¼"	CPA183084S5PKG
34¼"	CPA183684S5PKG
40¼"	CPA184284S5PKG
46¼"	CPA184884S5PKG
52¼"	CPA185484S5PKG
58¼"	CPA186084S5PKG
70¼"	CPA187284S5PKG

24"	CPU212484S5PKG
30"	CPU213084S5PKG
36"	CPU213684S5PKG
42"	CPU214284S5PKG
48"	CPU214884S5PKG
54"	CPU215484S5PKG
60"	CPU216084S5PKG
72"	CPU217284S5PKG

22¼"	CPA212484S5PKG
28¼"	CPA213084S5PKG
34¼"	CPA213684S5PKG
40¼"	CPA214284S5PKG
46¼"	CPA214884S5PKG
52¼"	CPA215484S5PKG
58¼"	CPA216084S5PKG
70¼"	CPA217284S5PKG

24"	CPU242484S5PKG
30"	CPU243084S5PKG
36"	CPU243684S5PKG
42"	CPU244284S5PKG
48"	CPU244884S5PKG
54"	CPU245484S5PKG
60"	CPU246084S5PKG
72"	CPU247284S5PKG

22¼"	CPA242484S5PKG
28¼"	CPA243084S5PKG
34¼"	CPA243684S5PKG
40¼"	CPA244284S5PKG
46¼"	CPA244884S5PKG
52¼"	CPA245484S5PKG
58¼"	CPA246084S5PKG
70¼"	CPA247284S5PKG

VS4PKG

4-Shelf Vented and Solid Stationary Starter and Add-On Units

(3 vented + 1 solid)

84"
HEIGHT

Units ship in 2 or 3 separate boxes with 1 or 2 unassembled post kits and 1 box of 4 or 5 shelves.

Starter

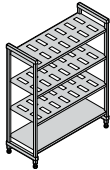

Add-On

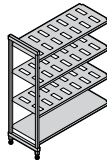

18"
DEPTH

LENGTH	CODE
24"	CPU182484VS4PKG
30"	CPU183084VS4PKG
36"	CPU183684VS4PKG
42"	CPU184284VS4PKG
48"	CPU184884VS4PKG
54"	CPU185484VS4PKG
60"	CPU186084VS4PKG
72"	CPU187284VS4PKG

LENGTH	CODE
22¼"	CPA182484VS4PKG
28¼"	CPA183084VS4PKG
34¼"	CPA183684VS4PKG
40¼"	CPA184284VS4PKG
46¼"	CPA184884VS4PKG
52¼"	CPA185484VS4PKG
58¼"	CPA186084VS4PKG
70¼"	CPA187284VS4PKG

Starter

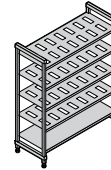

Add-On

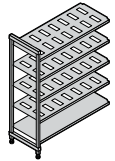

LENGTH	CODE
24"	CPU182484VS5PKG
30"	CPU183084VS5PKG
36"	CPU183684VS5PKG
42"	CPU184284VS5PKG
48"	CPU184884VS5PKG
54"	CPU185484VS5PKG
60"	CPU186084VS5PKG
72"	CPU187284VS5PKG

LENGTH	CODE
22¼"	CPA182484VS5PKG
28¼"	CPA183084VS5PKG
34¼"	CPA183684VS5PKG
40¼"	CPA184284VS5PKG
46¼"	CPA184884VS5PKG
52¼"	CPA185484VS5PKG
58¼"	CPA186084VS5PKG
70¼"	CPA187284VS5PKG

21"
DEPTH

24"	CPU212484VS4PKG
30"	CPU213084VS4PKG
36"	CPU213684VS4PKG
42"	CPU214284VS4PKG
48"	CPU214884VS4PKG
54"	CPU215484VS4PKG
60"	CPU216084VS4PKG
72"	CPU217284VS4PKG

22¼"	CPA212484VS4PKG
28¼"	CPA213084VS4PKG
34¼"	CPA213684VS4PKG
40¼"	CPA214284VS4PKG
46¼"	CPA214884VS4PKG
52¼"	CPA215484VS4PKG
58¼"	CPA216084VS4PKG
70¼"	CPA217284VS4PKG

24"	CPU212484VS5PKG
30"	CPU213084VS5PKG
36"	CPU213684VS5PKG
42"	CPU214284VS5PKG
48"	CPU214884VS5PKG
54"	CPU215484VS5PKG
60"	CPU216084VS5PKG
72"	CPU217284VS5PKG

22¼"	CPA212484VS5PKG
28¼"	CPA213084VS5PKG
34¼"	CPA213684VS5PKG
40¼"	CPA214284VS5PKG
46¼"	CPA214884VS5PKG
52¼"	CPA215484VS5PKG
58¼"	CPA216084VS5PKG
70¼"	CPA217284VS5PKG

24"
DEPTH

24"	CPU242484VS4PKG
30"	CPU243084VS4PKG
36"	CPU243684VS4PKG
42"	CPU244284VS4PKG
48"	CPU244884VS4PKG
54"	CPU245484VS4PKG
60"	CPU246084VS4PKG
72"	CPU247284VS4PKG

22¼"	CPA242484VS4PKG
28¼"	CPA243084VS4PKG
34¼"	CPA243684VS4PKG
40¼"	CPA244284VS4PKG
46¼"	CPA244884VS4PKG
52¼"	CPA245484VS4PKG
58¼"	CPA246084VS4PKG
70¼"	CPA247284VS4PKG

24"	CPU242484VS5PKG
30"	CPU243084VS5PKG
36"	CPU243684VS5PKG
42"	CPU244284VS5PKG
48"	CPU244884VS5PKG
54"	CPU245484VS5PKG
60"	CPU246084VS5PKG
72"	CPU247284VS5PKG

22¼"	CPA242484VS5PKG
28¼"	CPA243084VS5PKG
34¼"	CPA243684VS5PKG
40¼"	CPA244284VS5PKG
46¼"	CPA244884VS5PKG
52¼"	CPA245484VS5PKG
58¼"	CPA246084VS5PKG
70¼"	CPA247284VS5PKG

Color: Speckled Gray (480).

V4 4-Shelf Vented Mobile Units

V5 5-Shelf Vented Mobile Units

Mobile starter units include 2 factory assembled mobile post kits, 8 or 10 traverses, shelf plates and 4 premium swivel casters with total locking brake. Units ship complete in 1 box.

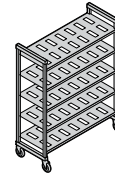
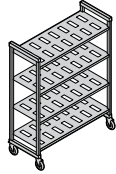

67"
HEIGHT

18"
DEPTH

CODE	DIMENSIONS D x L x H
CPMU183667V4	18" x 36" x 67"
CPMU184267V4	18" x 42" x 67"
CPMU184867V4	18" x 48" x 67"

21"
DEPTH

CPMU213667V4	21" x 36" x 67"
CPMU214267V4	21" x 42" x 67"
CPMU214867V4	21" x 48" x 67"

24"
DEPTH

CPMU243667V4	24" x 36" x 67"
CPMU244267V4	24" x 42" x 67"
CPMU244867V4	24" x 48" x 67"

75"
HEIGHT

18"
DEPTH

CODE	DIMENSIONS D x L x H
CPMU183675V4	18" x 36" x 75"
CPMU184275V4	18" x 42" x 75"
CPMU184875V4	18" x 48" x 75"

21"
DEPTH

CPMU213675V4	21" x 36" x 75"
CPMU214275V4	21" x 42" x 75"
CPMU214875V4	21" x 48" x 75"

24"
DEPTH

CPMU243675V4	24" x 36" x 75"
CPMU244275V4	24" x 42" x 75"
CPMU244875V4	24" x 48" x 75"

18"
DEPTH

CODE	DIMENSIONS D x L x H
CPMU183667V5	18" x 36" x 67"
CPMU184267V5	18" x 42" x 67"
CPMU184867V5	18" x 48" x 67"

21"
DEPTH

CPMU213667V5	21" x 36" x 67"
CPMU214267V5	21" x 42" x 67"
CPMU214867V5	21" x 48" x 67"

24"
DEPTH

CPMU243667V5	24" x 36" x 67"
CPMU244267V5	24" x 42" x 67"
CPMU244867V5	24" x 48" x 67"

18"
DEPTH

CODE	DIMENSIONS D x L x H
CPMU183675V5	18" x 36" x 75"
CPMU184275V5	18" x 42" x 75"
CPMU184875V5	18" x 48" x 75"

21"
DEPTH

CPMU213675V5	21" x 36" x 75"
CPMU214275V5	21" x 42" x 75"
CPMU214875V5	21" x 48" x 75"

24"
DEPTH

CPMU243675V5	24" x 36" x 75"
CPMU244275V5	24" x 42" x 75"
CPMU244875V5	24" x 48" x 75"

V4 4-Shelf Vented High Density Mobile Units

S4 4-Shelf Solid High Density Mobile Units

Units include 2 factory assembled mobile post kits, 8 traverses, shelf plates, 4 high density casters and 4 high density donut bumpers. Units ship complete in 1 box.

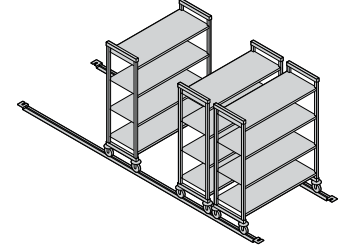
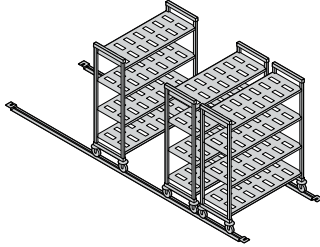

67"
HEIGHT

21"
DEPTH

CODE	DIMENSIONS D x L x H
CPHU213667V4	21" x 36" x 67"
CPHU214267V4	21" x 42" x 67"
CPHU214867V4	21" x 48" x 67"
CPHU215467V4	21" x 54" x 67"
CPHU216067V4	21" x 60" x 67"

24"
DEPTH

CPHU243667V4	24" x 36" x 67"
CPHU244267V4	24" x 42" x 67"
CPHU244867V4	24" x 48" x 67"
CPHU245467V4	24" x 54" x 67"
CPHU246067V4	24" x 60" x 67"

75"
HEIGHT

21"
DEPTH

CODE	DIMENSIONS D x L x H
CPHU213675V4	21" x 36" x 75"
CPHU214275V4	21" x 42" x 75"
CPHU214875V4	21" x 48" x 75"
CPHU215475V4	21" x 54" x 75"
CPHU216075V4	21" x 60" x 75"

24"
DEPTH

CPHU243675V4	24" x 36" x 75"
CPHU244275V4	24" x 42" x 75"
CPHU244875V4	24" x 48" x 75"
CPHU245475V4	24" x 54" x 75"
CPHU246075V4	24" x 60" x 75"

21"
DEPTH

CODE	DIMENSIONS D x L x H
CPHU213667S4	21" x 36" x 67"
CPHU214267S4	21" x 42" x 67"
CPHU214867S4	21" x 48" x 67"
CPHU215467S4	21" x 54" x 67"
CPHU216067S4	21" x 60" x 67"

24"
DEPTH

CPHU243667S4	24" x 36" x 67"
CPHU244267S4	24" x 42" x 67"
CPHU244867S4	24" x 48" x 67"
CPHU245467S4	24" x 54" x 67"
CPHU246067S4	24" x 60" x 67"

21"
DEPTH

CODE	DIMENSIONS D x L x H
CPHU213675S4	21" x 36" x 75"
CPHU214275S4	21" x 42" x 75"
CPHU214875S4	21" x 48" x 75"
CPHU215475S4	21" x 54" x 75"
CPHU216075S4	21" x 60" x 75"

24"
DEPTH

CPHU243675S4	24" x 36" x 75"
CPHU244275S4	24" x 42" x 75"
CPHU244875S4	24" x 48" x 75"
CPHU245475S4	24" x 54" x 75"
CPHU246075S4	24" x 60" x 75"

High Density Full Track and Track Extension Kits

Each kit ships complete in 1 box with aluminum raised track rails and stainless steel hardware required to complete installation.

CODE	DESCRIPTION	CASE PACK
Full Track Kits		
CSMHDTK10	10' Track for 3 Mobile Units*	1
CSMHDTK12	12' Track for 4 Mobile Units*	1
CSMHDTK145	14.5' Track for 5 Mobile Units*	1

Color: Silver (000). *Based on 24" deep mobile units.

Full Track Kits include: Track rails, rail joiners, end plates, 8 stainless steel leveling feet (for stationary units) and required hardware.

CODE	DESCRIPTION	CASE PACK
Track Extension Kits		
CSMHDTKE4	4.5' Track Extension	1
CSMHDTKE5	5' Track Extension	1
CSMHDTKE6	6' Track Extension	1

Color: Silver (000). **Extension Track Kits include:** Track rails (1 set), 2 rail joiners, and required hardware.



Track rail (underside) shown with end plate installed.



Track rail (underside) shown with track rail joiner partially installed.

It is highly recommended to install a stationary starter unit every 15' of track to further stabilize the system.

High Density Floor Fastener

Secure stationary unit front posts with rails directly to the floor for added safety and stability where required. Made of stainless steel. Bolts not included.

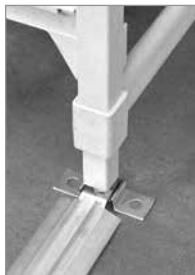

Hole diameter 9/16".

CODE	DIMENSION D x L x H
CSHDFF	1 3/8" x 4 1/4" x 1/2"

Case Pack: 4 **Color:** Silver (000).

High Density Caster With Donut Bumper



CODE	SIZE
CPMCHD	5"

Case Pack: 2 **Color:** Gray (000).



Stationary Post Kits

Includes 2 stationary posts, 1 top post connector and 1 bottom post connector. Ships **unassembled** in 1 box. Mobile and stationary posts are not interchangeable.



64"
HEIGHT

CODE	DIMENSIONS D x H
CPPK1464	14" x 64"
CPPK1864	18" x 64"
CPPK2164	21" x 64"
CPPK2464	24" x 64"

72"
HEIGHT

CPPK1472	14" x 72"
CPPK1872	18" x 72"
CPPK2172	21" x 72"
CPPK2472	24" x 72"

Color: Speckled Gray (480).

Standard Mobile Post Kits

Includes 2 mobile posts, 1 top post connector and 1 bottom post connector and **2 premium swivel casters** with total locking brake. Ships **unassembled** in 1 box. Mobile and stationary posts are not interchangeable.

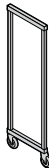

67"
HEIGHT

CODE	DIMENSIONS D x H
CPMPK1867	18" x 67"
CPMPK2167	21" x 67"
CPMPK2467	24" x 67"

75"
HEIGHT

CPMPK1875	18" x 75"
CPMPK2175	21" x 75"
CPMPK2475	24" x 75"

Color: Speckled Gray (480).

High Density Mobile Post Kits

Includes 2 mobile posts, 1 top post connector and 1 bottom post connector, **2 high density casters** and donut bumpers. Ships unassembled in 1 box. Mobile and stationary posts are not interchangeable.

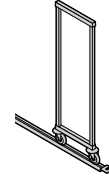

67"
HEIGHT

18"
DEPTH

CODE	DIMENSIONS D x H
CPMPKHD1867	18" x 67"

21"
DEPTH

CPMPKHD2167	21" x 67"
-------------	-----------

24"
DEPTH

CPMPKHD2467	24" x 67"
-------------	-----------

75"
HEIGHT

18"
DEPTH

CODE	DIMENSIONS D x H
CPMPKHD1875	18" x 75"

21"
DEPTH

CPMPKHD2175	21" x 75"
-------------	-----------

24"
DEPTH

CPMPKHD2475	24" x 75"
-------------	-----------

Color: Speckled Gray (480).

Donut Bumper for Standard Mobile Units

Offers added protection during transport and when maneuvering mobile units into place against walls or alongside other units for storage.

CODE	DIAMETER
CPMDB	3½"

Case Pack: 4 Color: Gray (000).



V1 Single Vented Shelf Kits

S1 Single Solid Shelf Kits

Includes 2 shelf traverses and vented or solid shelf plates. Fits mobile or stationary units. Ships in 1 box.

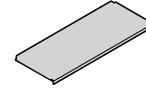
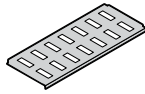

14"
DEPTH

CODE	DIMENSIONS D x L
CPSK1424V1	14" x 24"
CPSK1430V1	14" x 30"
CPSK1436V1	14" x 36"
CPSK1442V1	14" x 42"
CPSK1448V1	14" x 48"
CPSK1454V1	14" x 54"
CPSK1460V1	14" x 60"
CPSK1472V1	14" x 72"

14"
DEPTH

CODE	DIMENSIONS D x L
CPSK1424S1	14" x 24"
CPSK1430S1	14" x 30"
CPSK1436S1	14" x 36"
CPSK1442S1	14" x 42"
CPSK1448S1	14" x 48"
CPSK1454S1	14" x 54"
CPSK1460S1	14" x 60"
CPSK1472S1	14" x 72"

18"
DEPTH

CPSK1824V1	18" x 24"
CPSK1830V1	18" x 30"
CPSK1836V1	18" x 36"
CPSK1842V1	18" x 42"
CPSK1848V1	18" x 48"
CPSK1854V1	18" x 54"
CPSK1860V1	18" x 60"
CPSK1872V1	18" x 72"

18"
DEPTH

CPSK1824S1	18" x 24"
CPSK1830S1	18" x 30"
CPSK1836S1	18" x 36"
CPSK1842S1	18" x 42"
CPSK1848S1	18" x 48"
CPSK1854S1	18" x 54"
CPSK1860S1	18" x 60"
CPSK1872S1	18" x 72"

21"
DEPTH

CPSK2124V1	21" x 24"
CPSK2130V1	21" x 30"
CPSK2136V1	21" x 36"
CPSK2142V1	21" x 42"
CPSK2148V1	21" x 48"
CPSK2154V1	21" x 54"
CPSK2160V1	21" x 60"
CPSK2172V1	21" x 72"

21"
DEPTH

CPSK2124S1	21" x 24"
CPSK2130S1	21" x 30"
CPSK2136S1	21" x 36"
CPSK2142S1	21" x 42"
CPSK2148S1	21" x 48"
CPSK2154S1	21" x 54"
CPSK2160S1	21" x 60"
CPSK2172S1	21" x 72"

24"
DEPTH

CPSK2424V1	24" x 24"
CPSK2430V1	24" x 30"
CPSK2436V1	24" x 36"
CPSK2442V1	24" x 42"
CPSK2448V1	24" x 48"
CPSK2454V1	24" x 54"
CPSK2460V1	24" x 60"
CPSK2472V1	24" x 72"

24"
DEPTH

CPSK2424S1	24" x 24"
CPSK2430S1	24" x 30"
CPSK2436S1	24" x 36"
CPSK2442S1	24" x 42"
CPSK2448S1	24" x 48"
CPSK2454S1	24" x 54"
CPSK2460S1	24" x 60"
CPSK2472S1	24" x 72"

Color: Speckled Gray (480).

V4 4-Shelf Vented Kits

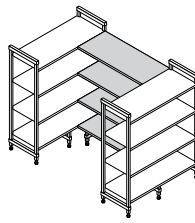

S4 4-Shelf Solid Kits

Includes 8 shelf traverses and vented or solid shelf plates. Fits mobile or stationary units.
Ships in 1 box. Install with 8 sets of corner connectors (CPC8) to create a U-shape unit.

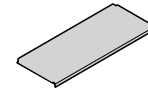
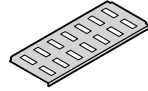

18"
DEPTH

CODE	DIMENSIONS D x L
CPSK1836V4	18" x 36"
CPSK1842V4	18" x 42"
CPSK1848V4	18" x 48"

CODE	DIMENSIONS D x L
CPSK1836S4	18" x 36"
CPSK1842S4	18" x 42"
CPSK1848S4	18" x 48"

21"
DEPTH

CPSK2136V4	21" x 36"
CPSK2142V4	21" x 42"
CPSK2148V4	21" x 48"

CPSK2136S4	21" x 36"
CPSK2142S4	21" x 42"
CPSK2148S4	21" x 48"

24"
DEPTH

CPSK2436V4	24" x 36"
CPSK2442V4	24" x 42"
CPSK2448V4	24" x 48"

CPSK2436S4	24" x 36"
CPSK2442S4	24" x 42"
CPSK2448S4	24" x 48"

V5 5-Shelf Vented Kits

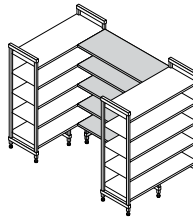

S5 5-Shelf Solid Kits

Includes 10 shelf traverses and vented or solid shelf plates. Fits mobile or stationary units.
Ships in 1 box. Install with 10 sets of corner connectors (CPC10) to create a U-shape unit.

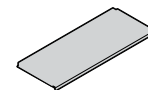
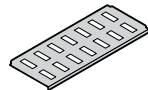

18"
DEPTH

CODE	DIMENSIONS D x L
CPSK1836V5	18" x 36"
CPSK1842V5	18" x 42"
CPSK1848V5	18" x 48"

CODE	DIMENSIONS D x L
CPSK1836S5	18" x 36"
CPSK1842S5	18" x 42"
CPSK1848S5	18" x 48"

21"
DEPTH

CPSK2136V5	21" x 36"
CPSK2142V5	21" x 42"
CPSK2148V5	21" x 48"

CPSK2136S5	21" x 36"
CPSK2142S5	21" x 42"
CPSK2148S5	21" x 48"

24"
DEPTH

CPSK2436V5	24" x 36"
CPSK2442V5	24" x 42"
CPSK2448V5	24" x 48"

CPSK2436S5	24" x 36"
CPSK2442S5	24" x 42"
CPSK2448S5	24" x 48"



VS4 4-Shelf Kits

(3 Vented + 1 Solid)

Includes 8 shelf traverses and vented or solid shelf plates.
Fits mobile or stationary units. Ships in one carton. Install with
8 sets of corner connectors (CPC8) to create a U-shape unit.

18"
DEPTH

CODE	DIMENSIONS D x L
CPSK1836VS4	18" x 36"
CPSK1842VS4	18" x 42"
CPSK1848VS4	18" x 48"

21"
DEPTH

CPSK2136VS4	21" x 36"
CPSK2142VS4	21" x 42"
CPSK2148VS4	21" x 48"

24"
DEPTH

CPSK2436VS4	24" x 36"
CPSK2442VS4	24" x 42"
CPSK2448VS4	24" x 48"

VS5 5-Shelf Kits

(4 Vented + 1 Solid)

Includes 10 shelf traverses and vented or solid shelf plates.
Fits mobile or stationary units. Ships in one carton. Install with
10 sets of corner connectors (CPC10) to create a U-shape unit.

18"
DEPTH

CODE	DIMENSIONS D x L
CPSK1836VS5	18" x 36"
CPSK1842VS5	18" x 42"
CPSK1848VS5	18" x 48"

21"
DEPTH

CPSK2136VS5	21" x 36"
CPSK2142VS5	21" x 42"
CPSK2148VS5	21" x 48"

24"
DEPTH

CPSK2436VS5	24" x 36"
CPSK2442VS5	24" x 42"
CPSK2448VS5	24" x 48"

Color: Speckled Gray (480).

Corner Connectors

Unique patented design ensures maximum shelf space utilization. Use 1 set per shelf to connect starter and add-on units in corners. Connect 4 or 5 intermediate shelves between 2 starter units (2 sets required per shelf).

CODE	DESCRIPTION
CPCC1	1 Set for 1 shelf
CPCC8	8 Sets for 4 shelves
CPCC10	10 Sets for 5 shelves

Color: Speckled Gray (480).

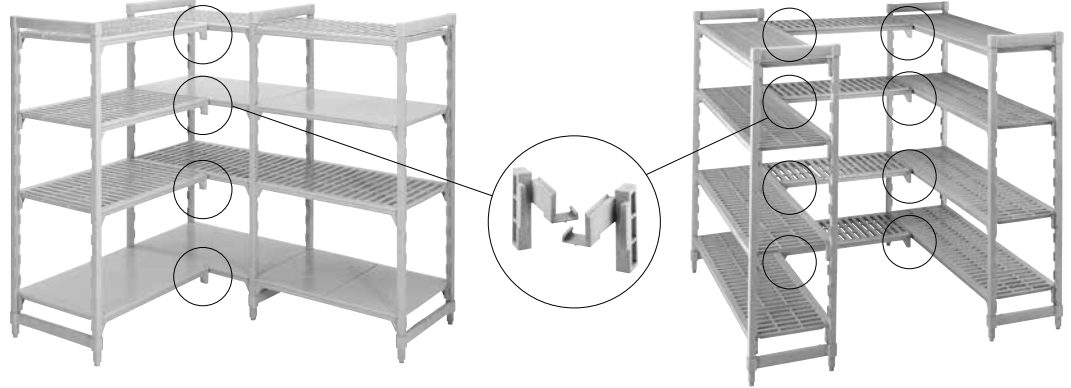

Bottom Shelf Dunnage Stands

Increase weight bearing capacity on bottom shelf only. Add to any shelf length. Highly recommended for starter units 54" and longer and all corner units, intermediate units and units specified for heavier load volume on and off bottom shelves.

Bottom Shelf with Dunnage Stand

UNIT LENGTH	WEIGHT BEARING
Standard Unit	
24" - 48"	1,200 lbs.
54" - 72"	900
Corner Unit with 2 Dunnage Stands	
24" - 48"	600

CODE	DIMENSIONS D x H
Dunnage Stand – Low (bottom shelf installed on lowest post dovetails)	
CPDS14H6	14" x 7½"
CPDS18H6	18" x 7½"
CPDS21H6	21" x 7½"
CPDS24H6	24" x 7½"

Dunnage Stand – Tall (bottom shelf installed on 2nd set up of post dovetails)	
CPDS14H11	14" x 11⅜"
CPDS18H11	18" x 11⅜"
CPDS21H11	21" x 11⅜"
CPDS24H11	24" x 11⅜"

Case Pack: 1 Color: Brushed Graphite (580).

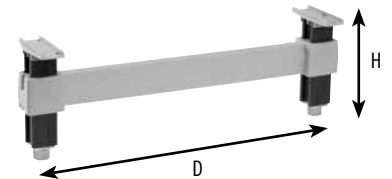

Shelf Traverses

Available in single or double packs. Use a single set to add an open shelf for divider bars or drying racks. Add single traverse on the back of the unit for extra support when significant space is required between the bottom and second shelf shelf or when placing rolling equipment under the first shelf.

LENGTH	SINGLE PACK CODE*	DOUBLE PACK CODE**
24"	CPTR24	CPTR242PK
30"	CPTR30	CPTR302PK
36"	CPTR36	CPTR362PK
42"	CPTR42	CPTR422PK
48"	CPTR48	CPTR482PK
54"	CPTR54	CPTR542PK
60"	CPTR60	CPTR602PK
72"	CPTR72	—

*Case Pack: 1 **Case Pack: 2 Color: Speckled Gray (480).



CAMSHELVING

ELEMENTS® XTRA

series

STATIONARY | MOBILE | HIGH DENSITY | UNDERCOUNTER

- Posts and traverses made of a revolutionary, extremely strong composite material with a smooth, easy to clean surface. Posts now have notches on the inside only for installing traverse dovetails.
- Removable polypropylene shelf plates with permanent, molded-in Camguard®, an antimicrobial technology that inhibits the growth of mold, fungus, and bacteria.
- Sturdy reinforced threaded nylon foot adjusts easily to level units.
- Withstands storage temperatures from -36°F to 190°F.
- Lifetime warranty against rust and corrosion.
- NEW patented post connector locks in place onto the wraparound collar wedge for solid, enhanced stability.
- NEW universal traverses can now be installed every 4" on both stationary and mobile units with new single snap on dovetail.
- NEW two piece, heavy-duty corner connectors featuring a "clasp" design offer zero loss of weight bearing in corners and greater weight bearing on middle shelves installed between units.



Post Connectors, Corner Connectors, Floor Fastener, Wall Fastener, Identification Tags, Single Shelf Security Cage, Ultimate #10 Can Rack, and Shelf Divider Bars are not NSF Listed.

camguard.
ANTIMICROBIAL SHELF PLATES



STARTER UNITS

Ship complete in 1 box. Includes factory assembled post frames for quicker assembly.

*Sold separately as shelf kits and post kits only.

Stationary Unit Sizes

4 Depths		8 Lengths			3 Heights		
14"*	18"	24"	30"	36"	64"	72"	84"
21"	24"	42"	48"	54"			
		60"	72"				

Standard Mobile

3 Depths			5 Lengths			2 Heights	
18"	21"	24"	36"	42"	48"	70 ¼"	
			54"	60"		78 ¼"	

Stationary Undercounter

2 Depths		3 Lengths			2 Heights	
14"	18"	24"	36"	48"	27 ¼" Mobile	30" Stationary

High Density Mobile

3 Depths			5 Lengths			2 Heights	
18"	21"	24"	36"	42"	48"	70 ¼"	
			54"	60"		78 ¼"	

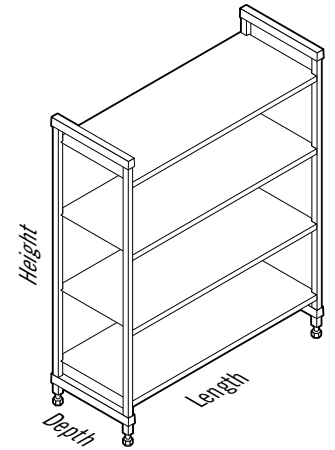

Weight Bearing Capacity

Weight must be evenly distributed across the entire shelf.

		UNIT LENGTH 24" – 60"	UNIT LENGTH 72"
SINGLE UNIT	Unit only	2,400 lbs.	2,400 lbs.
	Shelf only	800	600
	Unit with dunnage stand*	2,800	2,700
	Bottom shelf with dunnage stand*	1,200	900
		UNIT LENGTH 24" – 60"	
CORNER UNIT With 2 Dunnage Stands required	Unit only	2,400	—
	Shelf only	800	—
	Bottom shelf with dunnage stands*	1,200	—
		UNIT LENGTH 24" – 60"	
INTERMEDIATE SHELVES Shelves Installed Between 2 Units	Unit only	2,400	—
	Shelf only	800	—
	Bottom shelf with dunnage stands*	1,200	—
MOBILE UNIT	Unit only**	750	—

*Dunnage Stands add stability and increase weight bearing capacity on bottom shelf only. Add to any shelf length. Highly recommended for Starter Units 54" and longer, all Corner Units, U-Shape Units and units specified for heavier loads (See page 04-05).

**Due to the weight bearing capacity of casters, maximum weight load on an entire Mobile Unit is 750 lbs.

Corner connectors are for use only with shelves 24" - 60" long.

V4 4-Shelf Vented Units

V5 5-Shelf Vented Units

64"
HEIGHT

Starter units include 2 factory assembled stationary post kits, 8 or 10 traverses, traverse dovetails and shelf plates. Add-On units include 1 factory assembled stationary post kit, 8 or 10 traverses, traverse dovetails and shelf plates. Units ship complete in 1 box.

Starter

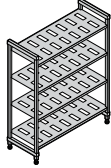

Add-On

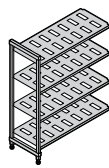

18"
DEPTH

LENGTH	CODE
24"	EXU182464V4
30"	EXU183064V4
36"	EXU183664V4
42"	EXU184264V4
48"	EXU184864V4
54"	EXU185464V4
60"	EXU186064V4
72"	EXU187264V4

LENGTH	CODE
22"	EXA182464V4
28"	EXA183064V4
34"	EXA183664V4
40"	EXA184264V4
46"	EXA184864V4
52"	EXA185464V4
58"	EXA186064V4
70"	EXA187264V4

Starter

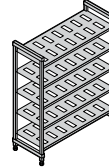

Add-On

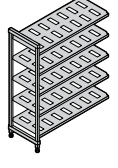

LENGTH	CODE
24"	EXU182464V5
30"	EXU183064V5
36"	EXU183664V5
42"	EXU184264V5
48"	EXU184864V5
54"	EXU185464V5
60"	EXU186064V5
72"	EXU187264V5

LENGTH	CODE
22"	EXA182464V5
28"	EXA183064V5
34"	EXA183664V5
40"	EXA184264V5
46"	EXA184864V5
52"	EXA185464V5
58"	EXA186064V5
70"	EXA187264V5

21"
DEPTH

24"	EXU212464V4
30"	EXU213064V4
36"	EXU213664V4
42"	EXU214264V4
48"	EXU214864V4
54"	EXU215464V4
60"	EXU216064V4
72"	EXU217264V4

22"	EXA212464V4
28"	EXA213064V4
34"	EXA213664V4
40"	EXA214264V4
46"	EXA214864V4
52"	EXA215464V4
58"	EXA216064V4
70"	EXA217264V4

24"	EXU212464V5
30"	EXU213064V5
36"	EXU213664V5
42"	EXU214264V5
48"	EXU214864V5
54"	EXU215464V5
60"	EXU216064V5
72"	EXU217264V5

22"	EXA212464V5
28"	EXA213064V5
34"	EXA213664V5
40"	EXA214264V5
46"	EXA214864V5
52"	EXA215464V5
58"	EXA216064V5
70"	EXA217264V5

24"
DEPTH

24"	EXU242464V4
30"	EXU243064V4
36"	EXU243664V4
42"	EXU244264V4
48"	EXU244864V4
54"	EXU245464V4
60"	EXU246064V4
72"	EXU247264V4

22"	EXA242464V4
28"	EXA243064V4
34"	EXA243664V4
40"	EXA244264V4
46"	EXA244864V4
52"	EXA245464V4
58"	EXA246064V4
70"	EXA247264V4

24"	EXU242464V5
30"	EXU243064V5
36"	EXU243664V5
42"	EXU244264V5
48"	EXU244864V5
54"	EXU245464V5
60"	EXU246064V5
72"	EXU247264V5

22"	EXA242464V5
28"	EXA243064V5
34"	EXA243664V5
40"	EXA244264V5
46"	EXA244864V5
52"	EXA245464V5
58"	EXA246064V5
70"	EXA247264V5

Color: Speckled Gray (480).

S4 4-Shelf Solid Units

VS4 4-Shelf Units (3 Vented + 1 Solid Shelf)

64"
HEIGHT

Starter units include 2 factory assembled stationary post kits, 8 traverses, traverse dovetails and shelf plates. Add-On units include 1 factory assembled stationary post kit, 8 traverses, traverse dovetails and shelf plates. Units ship complete in 1 box.

Starter

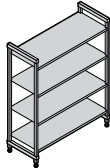

18"
DEPTH

Add-On

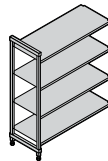

Starter

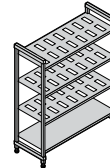

Add-On

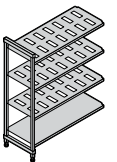

LENGTH	CODE
24"	EXU182464S4
30"	EXU183064S4
36"	EXU183664S4
42"	EXU184264S4
48"	EXU184864S4
54"	EXU185464S4
60"	EXU186064S4
72"	EXU187264S4

LENGTH	CODE
22"	EXA182464S4
28"	EXA183064S4
34"	EXA183664S4
40"	EXA184264S4
46"	EXA184864S4
52"	EXA185464S4
58"	EXA186064S4
70"	EXA187264S4

LENGTH	CODE
24"	EXU182464VS4
30"	EXU183064VS4
36"	EXU183664VS4
42"	EXU184264VS4
48"	EXU184864VS4
54"	EXU185464VS4
60"	EXU186064VS4
72"	EXU187264VS4

LENGTH	CODE
22"	EXA182464VS4
28"	EXA183064VS4
34"	EXA183664VS4
40"	EXA184264VS4
46"	EXA184864VS4
52"	EXA185464VS4
58"	EXA186064VS4
70"	EXA187264VS4

21"
DEPTH

24"	EXU212464S4
30"	EXU213064S4
36"	EXU213664S4
42"	EXU214264S4
48"	EXU214864S4
54"	EXU215464S4
60"	EXU216064S4
72"	EXU217264S4

22"	EXA212464S4
28"	EXA213064S4
34"	EXA213664S4
40"	EXA214264S4
46"	EXA214864S4
52"	EXA215464S4
58"	EXA216064S4
70"	EXA217264S4

24"	EXU212464VS4
30"	EXU213064VS4
36"	EXU213664VS4
42"	EXU214264VS4
48"	EXU214864VS4
54"	EXU215464VS4
60"	EXU216064VS4
72"	EXU217264VS4

22"	EXA212464VS4
28"	EXA213064VS4
34"	EXA213664VS4
40"	EXA214264VS4
46"	EXA214864VS4
52"	EXA215464VS4
58"	EXA216064VS4
70"	EXA217264VS4

24"
DEPTH

24"	EXU242464S4
30"	EXU243064S4
36"	EXU243664S4
42"	EXU244264S4
48"	EXU244864S4
54"	EXU245464S4
60"	EXU246064S4
72"	EXU247264S4

22"	EXA242464S4
28"	EXA243064S4
34"	EXA243664S4
40"	EXA244264S4
46"	EXA244864S4
52"	EXA245464S4
58"	EXA246064S4
70"	EXA247264S4

24"	EXU242464VS4
30"	EXU243064VS4
36"	EXU243664VS4
42"	EXU244264VS4
48"	EXU244864VS4
54"	EXU245464VS4
60"	EXU246064VS4
72"	EXU247264VS4

22"	EXA242464VS4
28"	EXA243064VS4
34"	EXA243664VS4
40"	EXA244264VS4
46"	EXA244864VS4
52"	EXA245464VS4
58"	EXA246064VS4
70"	EXA247264VS4

Color: Speckled Gray (480).

V4 4-Shelf Vented Units

V5 5-Shelf Vented Units

72"
HEIGHT

Starter units include 2 factory assembled stationary post kits, 8 or 10 traverses, traverse dovetails and shelf plates. Add-On units include 1 factory assembled stationary post kit, 8 or 10 traverses, traverse dovetails and shelf plates. Units ship complete in 1 box.

Starter

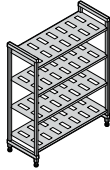

Add-On

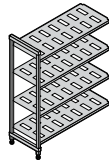

Starter

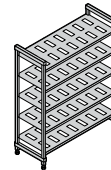

Add-On

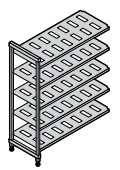

18"
DEPTH

LENGTH	CODE
24"	EXU182472V4
30"	EXU183072V4
36"	EXU183672V4
42"	EXU184272V4
48"	EXU184872V4
54"	EXU185472V4
60"	EXU186072V4
72"	EXU187272V4

LENGTH	CODE
22"	EXA182472V4
28"	EXA183072V4
34"	EXA183672V4
40"	EXA184272V4
46"	EXA184872V4
52"	EXA185472V4
58"	EXA186072V4
70"	EXA187272V4

LENGTH	CODE
24"	EXU182472V5
30"	EXU183072V5
36"	EXU183672V5
42"	EXU184272V5
48"	EXU184872V5
54"	EXU185472V5
60"	EXU186072V5
72"	EXU187272V5

LENGTH	CODE
22"	EXA182472V5
28"	EXA183072V5
34"	EXA183672V5
40"	EXA184272V5
46"	EXA184872V5
52"	EXA185472V5
58"	EXA186072V5
70"	EXA187272V5

21"
DEPTH

24"	EXU212472V4
30"	EXU213072V4
36"	EXU213672V4
42"	EXU214272V4
48"	EXU214872V4
54"	EXU215472V4
60"	EXU216072V4
72"	EXU217272V4

22"	EXA212472V4
28"	EXA213072V4
34"	EXA213672V4
40"	EXA214272V4
46"	EXA214872V4
52"	EXA215472V4
58"	EXA216072V4
70"	EXA217272V4

24"	EXU212472V5
30"	EXU213072V5
36"	EXU213672V5
42"	EXU214272V5
48"	EXU214872V5
54"	EXU215472V5
60"	EXU216072V5
72"	EXU217272V5

22"	EXA212472V5
28"	EXA213072V5
34"	EXA213672V5
40"	EXA214272V5
46"	EXA214872V5
52"	EXA215472V5
58"	EXA216072V5
70"	EXA217272V5

24"
DEPTH

24"	EXU242472V4
30"	EXU243072V4
36"	EXU243672V4
42"	EXU244272V4
48"	EXU244872V4
54"	EXU245472V4
60"	EXU246072V4
72"	EXU247272V4

22"	EXA242472V4
28"	EXA243072V4
34"	EXA243672V4
40"	EXA244272V4
46"	EXA244872V4
52"	EXA245472V4
58"	EXA246072V4
70"	EXA247272V4

24"	EXU242472V5
30"	EXU243072V5
36"	EXU243672V5
42"	EXU244272V5
48"	EXU244872V5
54"	EXU245472V5
60"	EXU246072V5
72"	EXU247272V5

22"	EXA242472V5
28"	EXA243072V5
34"	EXA243672V5
40"	EXA244272V5
46"	EXA244872V5
52"	EXA245472V5
58"	EXA246072V5
70"	EXA247272V5

Color: Speckled Gray (480).

S4 4-Shelf Solid Units

VS4 4-Shelf Units (3 Vented + 1 Solid)

72"
HEIGHT

Starter units include 2 factory assembled stationary post kits, 8 or 10 traverses, traverse dovetails and shelf plates. Add-On units include 1 factory assembled stationary post kit, 8 or 10 traverses, traverse dovetails and shelf plates. Units ship complete in 1 box.

Starter

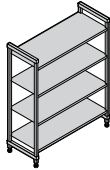

18"
DEPTH

Add-On

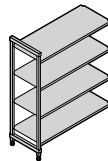

Starter

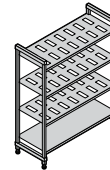

Add-On

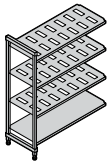

LENGTH	CODE
24"	EXU182472S4
30"	EXU183072S4
36"	EXU183672S4
42"	EXU184272S4
48"	EXU184872S4
54"	EXU185472S4
60"	EXU186072S4
72"	EXU187272S4

LENGTH	CODE
22"	EXA182472S4
28"	EXA183072S4
34"	EXA183672S4
40"	EXA184272S4
46"	EXA184872S4
52"	EXA185472S4
58"	EXA186072S4
70"	EXA187272S4

LENGTH	CODE
24"	EXU182472VS4
30"	EXU183072VS4
36"	EXU183672VS4
42"	EXU184272VS4
48"	EXU184872VS4
54"	EXU185472VS4
60"	EXU186072VS4
72"	EXU187272VS4

LENGTH	CODE
22"	EXA182472VS4
28"	EXA183072VS4
34"	EXA183672VS4
40"	EXA184272VS4
46"	EXA184872VS4
52"	EXA185472VS4
58"	EXA186072VS4
70"	EXA187272VS4

21"
DEPTH

24"	EXU212472S4
30"	EXU213072S4
36"	EXU213672S4
42"	EXU214272S4
48"	EXU214872S4
54"	EXU215472S4
60"	EXU216072S4
72"	EXU217272S4

22"	EXA212472S4
28"	EXA213072S4
34"	EXA213672S4
40"	EXA214272S4
46"	EXA214872S4
52"	EXA215472S4
58"	EXA216072S4
70"	EXA217272S4

24"	EXU212472VS4
30"	EXU213072VS4
36"	EXU213672VS4
42"	EXU214272VS4
48"	EXU214872VS4
54"	EXU215472VS4
60"	EXU216072VS4
72"	EXU217272VS4

22"	EXA212472VS4
28"	EXA213072VS4
34"	EXA213672VS4
40"	EXA214272VS4
46"	EXA214872VS4
52"	EXA215472VS4
58"	EXA216072VS4
70"	EXA217272VS4

24"
DEPTH

24"	EXU242472S4
30"	EXU243072S4
36"	EXU243672S4
42"	EXU244272S4
48"	EXU244872S4
54"	EXU245472S4
60"	EXU246072S4
72"	EXU247272S4

22"	EXA242472S4
28"	EXA243072S4
34"	EXA243672S4
40"	EXA244272S4
46"	EXA244872S4
52"	EXA245472S4
58"	EXA246072S4
70"	EXA247272S4

24"	EXU242472VS4
30"	EXU243072VS4
36"	EXU243672VS4
42"	EXU244272VS4
48"	EXU244872VS4
54"	EXU245472VS4
60"	EXU246072VS4
72"	EXU247272VS4

22"	EXA242472VS4
28"	EXA243072VS4
34"	EXA243672VS4
40"	EXA244272VS4
46"	EXA244872VS4
52"	EXA245472VS4
58"	EXA246072VS4
70"	EXA247272VS4

Color: Speckled Gray (480).

V4 4-Shelf Vented Units

V5 5-Shelf Vented Units

84"
HEIGHT

Starter units include 2 factory assembled stationary post kits, 8 or 10 traverses, traverse dovetails and shelf plates. Add-On units include 1 factory assembled stationary post kit, 8 or 10 traverses, traverse dovetails and shelf plates. Units ship complete in 1 box.

Starter

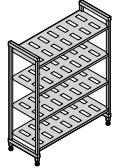

Add-On

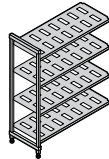

18"
DEPTH

LENGTH	CODE
24"	EXU182484V4
30"	EXU183084V4
36"	EXU183684V4
42"	EXU184284V4
48"	EXU184884V4
54"	EXU185484V4
60"	EXU186084V4
72"	EXU187284V4

LENGTH	CODE
22"	EXA182484V4
28"	EXA183084V4
34"	EXA183684V4
40"	EXA184284V4
46"	EXA184884V4
52"	EXA185484V4
58"	EXA186084V4
70"	EXA187284V4

Starter

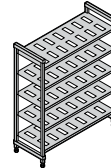

Add-On

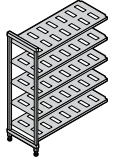

LENGTH	CODE
24"	EXU182484V5
30"	EXU183084V5
36"	EXU183684V5
42"	EXU184284V5
48"	EXU184884V5
54"	EXU185484V5
60"	EXU186084V5
72"	EXU187284V5

LENGTH	CODE
22"	EXA182484V5
28"	EXA183084V5
34"	EXA183684V5
40"	EXA184284V5
46"	EXA184884V5
52"	EXA185484V5
58"	EXA186084V5
70"	EXA187284V5

21"
DEPTH

24"	EXU212484V4
30"	EXU213084V4
36"	EXU213684V4
42"	EXU214284V4
48"	EXU214884V4
54"	EXU215484V4
60"	EXU216084V4
72"	EXU217284V4

22"	EXA212484V4
28"	EXA213084V4
34"	EXA213684V4
40"	EXA214284V4
46"	EXA214884V4
52"	EXA215484V4
58"	EXA216084V4
70"	EXA217284V4

24"	EXU212484V5
30"	EXU213084V5
36"	EXU213684V5
42"	EXU214284V5
48"	EXU214884V5
54"	EXU215484V5
60"	EXU216084V5
72"	EXU217284V5

22"	EXA212484V5
28"	EXA213084V5
34"	EXA213684V5
40"	EXA214284V5
46"	EXA214884V5
52"	EXA215484V5
58"	EXA216084V5
70"	EXA217284V5

24"
DEPTH

24"	EXU242484V4
30"	EXU243084V4
36"	EXU243684V4
42"	EXU244284V4
48"	EXU244884V4
54"	EXU245484V4
60"	EXU246084V4
72"	EXU247284V4

22"	EXA242484V4
28"	EXA243084V4
34"	EXA243684V4
40"	EXA244284V4
46"	EXA244884V4
52"	EXA245484V4
58"	EXA246084V4
70"	EXA247284V4

24"	EXU242484V5
30"	EXU243084V5
36"	EXU243684V5
42"	EXU244284V5
48"	EXU244884V5
54"	EXU245484V5
60"	EXU246084V5
72"	EXU247284V5

22"	EXA242484V5
28"	EXA243084V5
34"	EXA243684V5
40"	EXA244284V5
46"	EXA244884V5
52"	EXA245484V5
58"	EXA246084V5
70"	EXA247284V5

Color: Speckled Gray (480).

S4 4-Shelf Solid Units

S5 5-Shelf Solid Units

84"
HEIGHT

Starter units include 2 factory assembled stationary post kits, 8 or 10 traverses, traverse dovetails and shelf plates. Add-On units include 1 factory assembled stationary post kit, 8 or 10 traverses, traverse dovetails and shelf plates. Units ship complete in 1 box.

Starter

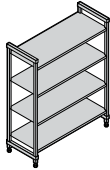

18"
DEPTH

Add-On

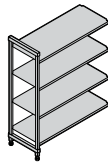

Starter

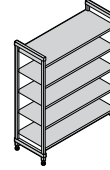

Add-On

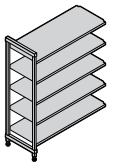

LENGTH	CODE
24"	EXU182484S4
30"	EXU183084S4
36"	EXU183684S4
42"	EXU184284S4
48"	EXU184884S4
54"	EXU185484S4
60"	EXU186084S4
72"	EXU187284S4

LENGTH	CODE
22"	EXA182484S4
28"	EXA183084S4
34"	EXA183684S4
40"	EXA184284S4
46"	EXA184884S4
52"	EXA185484S4
58"	EXA186084S4
70"	EXA187284S4

LENGTH	CODE
24"	EXU182484S5
30"	EXU183084S5
36"	EXU183684S5
42"	EXU184284S5
48"	EXU184884S5
54"	EXU185484S5
60"	EXU186084S5
72"	EXU187284S5

LENGTH	CODE
22"	EXA182484S5
28"	EXA183084S5
34"	EXA183684S5
40"	EXA184284S5
46"	EXA184884S5
52"	EXA185484S5
58"	EXA186084S5
70"	EXA187284S5

21"
DEPTH

24"	EXU212484S4
30"	EXU213084S4
36"	EXU213684S4
42"	EXU214284S4
48"	EXU214884S4
54"	EXU215484S4
60"	EXU216084S4
72"	EXU217284S4

22"	EXA212484S4
28"	EXA213084S4
34"	EXA213684S4
40"	EXA214284S4
46"	EXA214884S4
52"	EXA215484S4
58"	EXA216084S4
70"	EXA217284S4

24"	EXU212484S5
30"	EXU213084S5
36"	EXU213684S5
42"	EXU214284S5
48"	EXU214884S5
54"	EXU215484S5
60"	EXU216084S5
72"	EXU217284S5

22"	EXA212484S5
28"	EXA213084S5
34"	EXA213684S5
40"	EXA214284S5
46"	EXA214884S5
52"	EXA215484S5
58"	EXA216084S5
70"	EXA217284S5

24"
DEPTH

24"	EXU242484S4
30"	EXU243084S4
36"	EXU243684S4
42"	EXU244284S4
48"	EXU244884S4
54"	EXU245484S4
60"	EXU246084S4
72"	EXU247284S4

22"	EXA242484S4
28"	EXA243084S4
34"	EXA243684S4
40"	EXA244284S4
46"	EXA244884S4
52"	EXA245484S4
58"	EXA246084S4
70"	EXA247284S4

24"	EXU242484S5
30"	EXU243084S5
36"	EXU243684S5
42"	EXU244284S5
48"	EXU244884S5
54"	EXU245484S5
60"	EXU246084S5
72"	EXU247284S5

22"	EXA242484S5
28"	EXA243084S5
34"	EXA243684S5
40"	EXA244284S5
46"	EXA244884S5
52"	EXA245484S5
58"	EXA246084S5
70"	EXA247284S5

Color: Speckled Gray (480).

VS4 4-Shelf Units

(3 Vented + 1 Solid Shelf)

84"
HEIGHT

Starter units include 2 factory assembled stationary post kits, 8 or 10 traverses, traverse dovetails and shelf plates. Add-On units include 1 factory assembled stationary post kit, 8 or 10 traverses, traverse dovetails and shelf plates. Units ship complete in 1 box.

18"
DEPTH

Starter

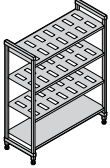

Add-On

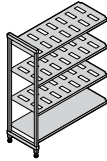

LENGTH	CODE
24"	EXU182484VS4
30"	EXU183084VS4
36"	EXU183684VS4
42"	EXU184284VS4
48"	EXU184884VS4
54"	EXU185484VS4
60"	EXU186084VS4
72"	EXU187284VS4

LENGTH	CODE
22"	EXA182484VS4
28"	EXA183084VS4
34"	EXA183684VS4
40"	EXA184284VS4
46"	EXA184884VS4
52"	EXA185484VS4
58"	EXA186084VS4
70"	EXA187284VS4

21"
DEPTH

24"	EXU212484VS4
30"	EXU213084VS4
36"	EXU213684VS4
42"	EXU214284VS4
48"	EXU214884VS4
54"	EXU215484VS4
60"	EXU216084VS4
72"	EXU217284VS4

22"	EXA212484VS4
28"	EXA213084VS4
34"	EXA213684VS4
40"	EXA214284VS4
46"	EXA214884VS4
52"	EXA215484VS4
58"	EXA216084VS4
70"	EXA217284VS4

24"
DEPTH

24"	EXU242484VS4
30"	EXU243084VS4
36"	EXU243684VS4
42"	EXU244284VS4
48"	EXU244884VS4
54"	EXU245484VS4
60"	EXU246084VS4
72"	EXU247284VS4

22"	EXA242484VS4
28"	EXA243084VS4
34"	EXA243684VS4
40"	EXA244284VS4
46"	EXA244884VS4
52"	EXA245484VS4
58"	EXA246084VS4
70"	EXA247284VS4

VS5 5-Shelf Units

(4 Vented + 1 Solid Shelf)

Starter

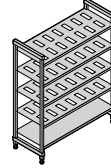

Add-On

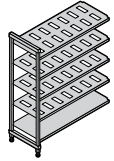

LENGTH	CODE
24"	EXU182484VS5
30"	EXU183084VS5
36"	EXU183684VS5
42"	EXU184284VS5
48"	EXU184884VS5
54"	EXU185484VS5
60"	EXU186084VS5
72"	EXU187284VS5

LENGTH	CODE
22"	EXA182484VS5
28"	EXA183084VS5
34"	EXA183684VS5
40"	EXA184284VS5
46"	EXA184884VS5
52"	EXA185484VS5
58"	EXA186084VS5
70"	EXA187284VS5

24"	EXU212484VS5
30"	EXU213084VS5
36"	EXU213684VS5
42"	EXU214284VS5
48"	EXU214884VS5
54"	EXU215484VS5
60"	EXU216084VS5
72"	EXU217284VS5

22"	EXA212484VS5
28"	EXA213084VS5
34"	EXA213684VS5
40"	EXA214284VS5
46"	EXA214884VS5
52"	EXA215484VS5
58"	EXA216084VS5
70"	EXA217284VS5

24"	EXU242484VS5
30"	EXU243084VS5
36"	EXU243684VS5
42"	EXU244284VS5
48"	EXU244884VS5
54"	EXU245484VS5
60"	EXU246084VS5
72"	EXU247284VS5

22"	EXA242484VS5
28"	EXA243084VS5
34"	EXA243684VS5
40"	EXA244284VS5
46"	EXA244884VS5
52"	EXA245484VS5
58"	EXA246084VS5
70"	EXA247284VS5

V4 4-Shelf Vented Mobile Units

V5 5-Shelf Vented Mobile Units

Mobile units include 2 factory assembled mobile post kits, 8 or 10 traverses, traverse dovetails, shelf plates, and 4 premium swivel casters with total locking brake. Units ship complete in 1 box.

70¼"

HEIGHT

includes 127 mm casters.

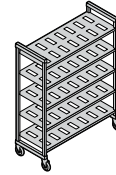
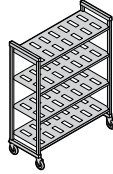

18"
DEPTH

CODE	DIMENSIONS D x L x H
EXMU183670V4	18" x 36" x 70¼"
EXMU184270V4	18" x 42" x 70¼"
EXMU184870V4	18" x 48" x 70¼"
EXMU185470V4	18" x 54" x 70¼"
EXMU186070V4	18" x 60" x 70¼"

18"
DEPTH

CODE	DIMENSIONS D x L x H
EXMU183670V5	18" x 36" x 70¼"
EXMU184270V5	18" x 42" x 70¼"
EXMU184870V5	18" x 48" x 70¼"
EXMU185470V5	18" x 54" x 70¼"
EXMU186070V5	18" x 60" x 70¼"

21"
DEPTH

EXMU213670V4	21" x 36" x 70¼"
EXMU214270V4	21" x 42" x 70¼"
EXMU214870V4	21" x 48" x 70¼"
EXMU215470V4	21" x 54" x 70¼"
EXMU216070V4	21" x 60" x 70¼"

21"
DEPTH

EXMU213670V5	21" x 36" x 70¼"
EXMU214270V5	21" x 42" x 70¼"
EXMU214870V5	21" x 48" x 70¼"
EXMU215470V5	21" x 54" x 70¼"
EXMU216070V5	21" x 60" x 70¼"

24"
DEPTH

EXMU243670V4	24" x 36" x 70¼"
EXMU244270V4	24" x 42" x 70¼"
EXMU244870V4	24" x 48" x 70¼"
EXMU245470V4	24" x 54" x 70¼"
EXMU246070V4	24" x 60" x 70¼"

24"
DEPTH

EXMU243670V5	24" x 36" x 70¼"
EXMU244270V5	24" x 42" x 70¼"
EXMU244870V5	24" x 48" x 70¼"
EXMU245470V5	24" x 54" x 70¼"
EXMU246070V5	24" x 60" x 70¼"

78¼"

HEIGHT

includes 127 mm casters.

18"
DEPTH

CODE	DIMENSIONS D x L x H
EXMU183678V4	18" x 36" x 78¼"
EXMU184278V4	18" x 42" x 78¼"
EXMU184878V4	18" x 48" x 78¼"
EXMU185478V4	18" x 54" x 78¼"
EXMU186078V4	18" x 60" x 78¼"

18"
DEPTH

CODE	DIMENSIONS D x L x H
EXMU183678V5	18" x 36" x 78¼"
EXMU184278V5	18" x 42" x 78¼"
EXMU184878V5	18" x 48" x 78¼"
EXMU185478V5	18" x 54" x 78¼"
EXMU186078V5	18" x 60" x 78¼"

21"
DEPTH

EXMU213678V4	21" x 36" x 78¼"
EXMU214278V4	21" x 42" x 78¼"
EXMU214878V4	21" x 48" x 78¼"
EXMU215478V4	21" x 54" x 78¼"
EXMU216078V4	21" x 60" x 78¼"

21"
DEPTH

EXMU213678V5	21" x 36" x 78¼"
EXMU214278V5	21" x 42" x 78¼"
EXMU214878V5	21" x 48" x 78¼"
EXMU215478V5	21" x 54" x 78¼"
EXMU216078V5	21" x 60" x 78¼"

24"
DEPTH

EXMU243678V4	24" x 36" x 78¼"
EXMU244278V4	24" x 42" x 78¼"
EXMU244878V4	24" x 48" x 78¼"
EXMU245478V4	24" x 54" x 78¼"
EXMU246078V4	24" x 60" x 78¼"

24"
DEPTH

EXMU243678V5	24" x 36" x 78¼"
EXMU244278V5	24" x 42" x 78¼"
EXMU244878V5	24" x 48" x 78¼"
EXMU245478V5	24" x 54" x 78¼"
EXMU246078V5	24" x 60" x 78¼"

Color: Speckled Gray (480).

V4 4-Shelf Vented High Density Mobile Units

70¹/₄"
HEIGHT

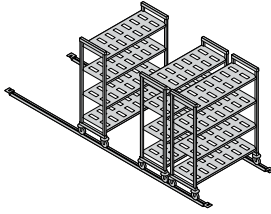

Units include 2 factory assembled mobile post kits,
8 traverses, shelf plates, 4 high density casters and
4 high density donut bumpers. Units ship complete in 1 box.

18"
DEPTH

CODE	DIMENSIONS D x L x H
EXHD183670V4	18" x 36" x 70 ¹ / ₄ "
EXHD184270V4	18" x 42" x 70 ¹ / ₄ "
EXHD184870V4	18" x 48" x 70 ¹ / ₄ "
EXHD185470V4	18" x 54" x 70 ¹ / ₄ "
EXHD186070V4	18" x 60" x 70 ¹ / ₄ "

21"
DEPTH

EXHD213670V4	21" x 36" x 70 ¹ / ₄ "
EXHD214270V4	21" x 42" x 70 ¹ / ₄ "
EXHD214870V4	21" x 48" x 70 ¹ / ₄ "
EXHD215470V4	21" x 54" x 70 ¹ / ₄ "
EXHD216070V4	21" x 60" x 70 ¹ / ₄ "

24"
DEPTH

EXHD243670V4	24" x 36" x 70 ¹ / ₄ "
EXHD244270V4	24" x 42" x 70 ¹ / ₄ "
EXHD244870V4	24" x 48" x 70 ¹ / ₄ "
EXHD245470V4	24" x 54" x 70 ¹ / ₄ "
EXHD246070V4	24" x 60" x 70 ¹ / ₄ "

78¹/₄"
HEIGHT

18"
DEPTH

CODE	DIMENSIONS D x L x H
EXHD183678V4	18" x 36" x 78 ¹ / ₄ "
EXHD184278V4	18" x 42" x 78 ¹ / ₄ "
EXHD184878V4	18" x 48" x 78 ¹ / ₄ "
EXHD185478V4	18" x 54" x 78 ¹ / ₄ "
EXHD186078V4	18" x 60" x 78 ¹ / ₄ "

21"
DEPTH

EXHD213678V4	21" x 36" x 78 ¹ / ₄ "
EXHD214278V4	21" x 42" x 78 ¹ / ₄ "
EXHD214878V4	21" x 48" x 78 ¹ / ₄ "
EXHD215478V4	21" x 54" x 78 ¹ / ₄ "
EXHD216078V4	21" x 60" x 78 ¹ / ₄ "

24"
DEPTH

EXHD243678V4	24" x 36" x 78 ¹ / ₄ "
EXHD244278V4	24" x 42" x 78 ¹ / ₄ "
EXHD244878V4	24" x 48" x 78 ¹ / ₄ "
EXHD245478V4	24" x 54" x 78 ¹ / ₄ "
EXHD246078V4	24" x 60" x 78 ¹ / ₄ "

S4 4-Shelf Solid High Density Mobile Units

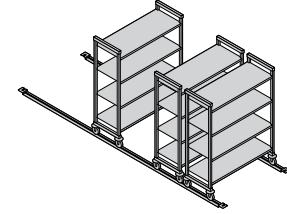

18"
DEPTH

CODE	DIMENSIONS D x L x H
EXHD183670S4	18" x 36" x 70 ¹ / ₄ "
EXHD184270S4	18" x 42" x 70 ¹ / ₄ "
EXHD184870S4	18" x 48" x 70 ¹ / ₄ "
EXHD185470S4	18" x 54" x 70 ¹ / ₄ "
EXHD186070S4	18" x 60" x 70 ¹ / ₄ "

21"
DEPTH

EXHD213670S4	21" x 36" x 70 ¹ / ₄ "
EXHD214270S4	21" x 42" x 70 ¹ / ₄ "
EXHD214870S4	21" x 48" x 70 ¹ / ₄ "
EXHD215470S4	21" x 54" x 70 ¹ / ₄ "
EXHD216070S4	21" x 60" x 70 ¹ / ₄ "

24"
DEPTH

EXHD243670S4	24" x 36" x 70 ¹ / ₄ "
EXHD244270S4	24" x 42" x 70 ¹ / ₄ "
EXHD244870S4	24" x 48" x 70 ¹ / ₄ "
EXHD245470S4	24" x 54" x 70 ¹ / ₄ "
EXHD246070S4	24" x 60" x 70 ¹ / ₄ "

18"
DEPTH

CODE	DIMENSIONS D x L x H
EXHD183678S4	18" x 36" x 78 ¹ / ₄ "
EXHD184278S4	18" x 42" x 78 ¹ / ₄ "
EXHD184878S4	18" x 48" x 78 ¹ / ₄ "
EXHD185478S4	18" x 54" x 78 ¹ / ₄ "
EXHD186078S4	18" x 60" x 78 ¹ / ₄ "

21"
DEPTH

EXHD213678S4	21" x 36" x 78 ¹ / ₄ "
EXHD214278S4	21" x 42" x 78 ¹ / ₄ "
EXHD214878S4	21" x 48" x 78 ¹ / ₄ "
EXHD215478S4	21" x 54" x 78 ¹ / ₄ "
EXHD216078S4	21" x 60" x 78 ¹ / ₄ "

24"
DEPTH

EXHD243678S4	24" x 36" x 78 ¹ / ₄ "
EXHD244278S4	24" x 42" x 78 ¹ / ₄ "
EXHD244878S4	24" x 48" x 78 ¹ / ₄ "
EXHD245478S4	24" x 54" x 78 ¹ / ₄ "
EXHD246078S4	24" x 60" x 78 ¹ / ₄ "

Color: Speckled Gray (480).

High Density Full Track and Track Extension Kits

Each kit ships complete in 1 box with aluminum raised track rails and stainless steel hardware required to complete installation.

CODE	DESCRIPTION	CASE PACK
Full Track Kits		
CSMHDTK10	10' Track for 3 Mobile Units*	1
CSMHDTK12	12' Track for 4 Mobile Units*	1
CSMHDTK145	14.5' Track for 5 Mobile Units*	1

Color: Silver (000). *Based on 24" deep mobile units.

Full Track Kits include: Track rails, rail joiners, end plates, 8 stainless steel leveling feet (for stationary units) and required hardware.

CODE	DESCRIPTION	CASE PACK
Track Extension Kits		
CSMHDTKE4	4.5' Track Extension	1
CSMHDTKE5	5' Track Extension	1
CSMHDTKE6	6' Track Extension	1

Color: Silver (000). **Extension Track Kits include:** Track rails (1 set), 2 rail joiners, and required hardware.



Track rail (underside) shown with end plate installed.



Track rail (underside) shown with track rail joiner partially installed

It is highly recommended to install a stationary starter unit every 15' of track to further stabilize the system.

High Density Floor Fastener

Secure stationary unit front posts with rails directly to the floor for added safety and stability where required. Made of stainless steel. Bolts not included.

CODE	DIMENSION D x L x H
CSHDFE	1 3/8" x 4 1/4" x 1/2"

Case Pack: 4 **Color:** Silver (000).

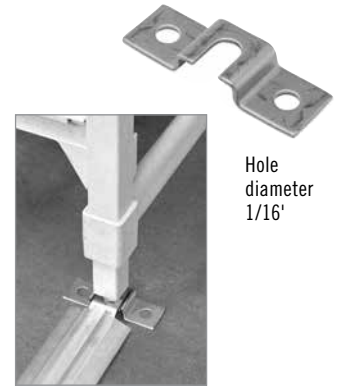

Hole diameter 1/16"

High Density Caster With Donut Bumper



CODE	SIZE
EXMCHD	5"

Case Pack: 2 **Color:** Gray (000).



Stationary Post Kits

Includes 2 stationary posts, 1 top and bottom post connector and post connector wedges. Ships unassembled in 1 box.

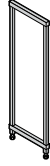

18"
DEPTH

CODE	DIMENSIONS D x H
EXPK1830	18" x 30"

Height is suitable for undercounter or table.

64"
DEPTH

EXPK1464	14" x 64"
EXPK1864	18" x 64"
EXPK2164	21" x 64"
EXPK2464	24" x 64"

72"
DEPTH

EXPK1472	14" x 72"
EXPK1872	18" x 72"
EXPK2172	21" x 72"
EXPK2472	24" x 72"

84"
DEPTH

EXPK1484	14" x 84"
EXPK1884	18" x 84"
EXPK2184	21" x 84"
EXPK2484	24" x 84"

Color: Speckled Gray (480).

Standard Mobile Post Kits

Ships **unassembled** in 1 box. Includes 2 mobile posts, post connectors, post connector wedges and 2 swivel, total locking casters.

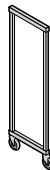

70¼"
HEIGHT

CODE	DIMENSIONS D x H
EXMPK1870	18" x 70¼"
EXMPK2170	21" x 70¼"
EXMPK2470	24" x 70¼"

78¼"
HEIGHT

EXMPK1878	18" x 78¼"
EXMPK2178	21" x 78¼"
EXMPK2478	24" x 78¼"

Color: Speckled Gray (480).

High Density Mobile Post Kits

Includes 2 mobile posts, 1 top post connector and 1 bottom post connector, **2 high density casters** and donut bumpers. Ships unassembled in 1 box.

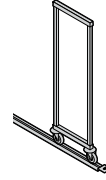

70¼"
HEIGHT

18"
DEPTH

CODE	DIMENSIONS D x H
EXHDPK1870	18" x 70¼"

21"
DEPTH

EXHDPK2170	21" x 70¼"
------------	------------

24"
DEPTH

EXHDPK2470	24" x 70¼"
------------	------------

78¼"
HEIGHT

18"
DEPTH

CODE	DIMENSIONS D x H
EXHDPK1878	18" x 78¼"

21"
DEPTH

EXHDPK2178	21" x 78¼"
------------	------------

24"
DEPTH

EXHDPK2478	24" x 78¼"
------------	------------

Color: Speckled Gray (480).

Donut Bumper for Standard or High Density Mobile Units

Offers added protection during transport and when maneuvering mobile units into place against walls or alongside other units for storage.

CODE	DIAMETER
CSMHDDB	5"

Case Pack: 4 Color: Gray (000).



V1 Single Vented Shelf Kits

S1 Single Solid Shelf Kits

Install on stationary or mobile units. Includes 2 shelf traverses, traverse dovetails and vented or solid shelf plates. Ships in 1 box.

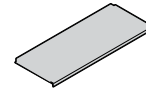
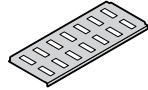

14"
DEPTH

CODE	DIMENSIONS D x L
EXSK1424V1	14" x 24"
EXSK1430V1	14" x 30"
EXSK1436V1	14" x 36"
EXSK1442V1	14" x 42"
EXSK1448V1	14" x 48"
EXSK1454V1	14" x 54"
EXSK1460V1	14" x 60"
EXSK1472V1	14" x 72"

14"
DEPTH

CODE	DIMENSIONS D x L
EXSK1424S1	14" x 24"
EXSK1430S1	14" x 30"
EXSK1436S1	14" x 36"
EXSK1442S1	14" x 42"
EXSK1448S1	14" x 48"
EXSK1454S1	14" x 54"
EXSK1460S1	14" x 60"
EXSK1472S1	14" x 72"

18"
DEPTH

EXSK1824V1	18" x 24"
EXSK1830V1	18" x 30"
EXSK1836V1	18" x 36"
EXSK1842V1	18" x 42"
EXSK1848V1	18" x 48"
EXSK1854V1	18" x 54"
EXSK1860V1	18" x 60"
EXSK1872V1	18" x 72"

18"
DEPTH

EXSK1824S1	18" x 24"
EXSK1830S1	18" x 30"
EXSK1836S1	18" x 36"
EXSK1842S1	18" x 42"
EXSK1848S1	18" x 48"
EXSK1854S1	18" x 54"
EXSK1860S1	18" x 60"
EXSK1872S1	18" x 72"

21"
DEPTH

EXSK2124V1	21" x 24"
EXSK2130V1	21" x 30"
EXSK2136V1	21" x 36"
EXSK2142V1	21" x 42"
EXSK2148V1	21" x 48"
EXSK2154V1	21" x 54"
EXSK2160V1	21" x 60"
EXSK2172V1	21" x 72"

21"
DEPTH

EXSK2124S1	21" x 24"
EXSK2130S1	21" x 30"
EXSK2136S1	21" x 36"
EXSK2142S1	21" x 42"
EXSK2148S1	21" x 48"
EXSK2154S1	21" x 54"
EXSK2160S1	21" x 60"
EXSK2172S1	21" x 72"

24"
DEPTH

EXSK2424V1	24" x 24"
EXSK2430V1	24" x 30"
EXSK2436V1	24" x 36"
EXSK2442V1	24" x 42"
EXSK2448V1	24" x 48"
EXSK2454V1	24" x 54"
EXSK2460V1	24" x 60"
EXSK2472V1	24" x 72"

24"
DEPTH

EXSK2424S1	24" x 24"
EXSK2430S1	24" x 30"
EXSK2436S1	24" x 36"
EXSK2442S1	24" x 42"
EXSK2448S1	24" x 48"
EXSK2454S1	24" x 54"
EXSK2460S1	24" x 60"
EXSK2472S1	24" x 72"

Color: Speckled Gray (480).

V4 4-Shelf Vented Kits

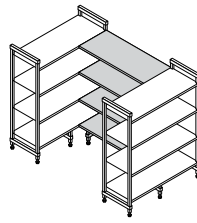

S4 4-Shelf Solid Kits

Install on stationary or mobile units. Includes 8 shelf traverses, traverse dovetails and vented or solid shelf plates. Ships in 1 box. Install 4 middle shelves (60" or less) between 2 starter units with 8 sets of corner connectors (2 each EXCC4480) to create U-shape.

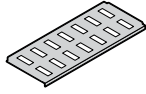

18"
DEPTH

CODE	DIMENSIONS D x L
EXSK1836V4	18" x 36"
EXSK1842V4	18" x 42"
EXSK1848V4	18" x 48"

21"
DEPTH

EXSK2136V4	21" x 36"
EXSK2142V4	21" x 42"
EXSK2148V4	21" x 48"

24"
DEPTH

EXSK2436V4	24" x 36"
EXSK2442V4	24" x 42"
EXSK2448V4	24" x 48"

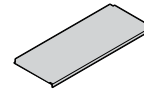

18"
DEPTH

CODE	DIMENSIONS D x L
EXSK1836S4	18" x 36"
EXSK1842S4	18" x 42"
EXSK1848S4	18" x 48"

21"
DEPTH

EXSK2136S4	21" x 36"
EXSK2142S4	21" x 42"
EXSK2148S4	21" x 48"

24"
DEPTH

EXSK2436S4	24" x 36"
EXSK2442S4	24" x 42"
EXSK2448S4	24" x 48"

V5 5-Shelf Vented Kits

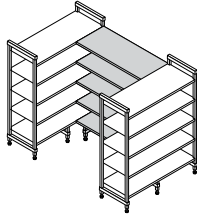

S5 5-Shelf Solid Kits

Install on stationary or mobile units. Includes 10 shelf traverses, traverse dovetails and vented or solid shelf plates. Ships in 1 box. Install 5 middle shelves (60" or less) between 2 starter units with 10 sets of corner connectors (2 each EXCC5480) to create U-shape.

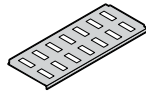

18"
DEPTH

CODE	DIMENSIONS D x L
EXSK1836V5	18" x 36"
EXSK1842V5	18" x 42"
EXSK1848V5	18" x 48"

21"
DEPTH

EXSK2136V5	21" x 36"
EXSK2142V5	21" x 42"
EXSK2148V5	21" x 48"

24"
DEPTH

EXSK2436V5	24" x 36"
EXSK2442V5	24" x 42"
EXSK2448V5	24" x 48"

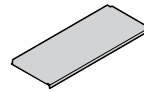

18"
DEPTH

CODE	DIMENSIONS D x L
EXSK1836S5	18" x 36"
EXSK1842S5	18" x 42"
EXSK1848S5	18" x 48"

21"
DEPTH

EXSK2136S5	21" x 36"
EXSK2142S5	21" x 42"
EXSK2148S5	21" x 48"

24"
DEPTH

EXSK2436S5	24" x 36"
EXSK2442S5	24" x 42"
EXSK2448S5	24" x 48"

Color: Speckled Gray (480).

VS4 4-Shelf Kits

(3 Vented + 1 Solid)

Install on stationary or mobile units. Includes 8 shelf traverses, traverse dovetails and vented or solid shelf plates.

Ships in 1 box. Install 4 middle shelves (60" or less) between 2 starter units with 8 sets of corner connectors (2 each EXCC4480) to create U-shape.

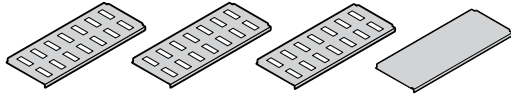

18"
DEPTH

CODE	DIMENSIONS D x L
EXSK1836VS4	18" x 36"
EXSK1842VS4	18" x 42"
EXSK1848VS4	18" x 48"

21"
DEPTH

EXSK2136VS4	21" x 36"
EXSK2142VS4	21" x 42"
EXSK2148VS4	21" x 48"

24"
DEPTH

EXSK2436VS4	24" x 36"
EXSK2442VS4	24" x 42"
EXSK2448VS4	24" x 48"

Color: Speckled Gray (480).

VS5 5-Shelf Kits

(4 Vented + 1 Solid)

Install on stationary or mobile units. Includes 10 shelf traverses, traverse dovetails and vented or solid shelf plates.

Ships in 1 box. Install 5 middle shelves (60" or less) between 2 starter units with 10 sets of corner connectors (2 each EXCC5480) to create U-shape.

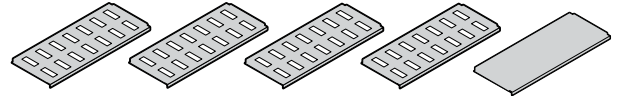

18"
DEPTH

CODE	DIMENSIONS D x L
EXSK1836VS5	18" x 36"
EXSK1842VS5	18" x 42"
EXSK1848VS5	18" x 48"

21"
DEPTH

EXSK2136VS5	21" x 36"
EXSK2142VS5	21" x 42"
EXSK2148VS5	21" x 48"

24"
DEPTH

EXSK2436VS5	24" x 36"
EXSK2442VS5	24" x 42"
EXSK2448VS5	24" x 48"



Corner Connectors

Unique clasp design ensures maximum shelf space utilization without loss of weight bearing in corners and increased weight bearing on middle shelves between units. Use 1 set per shelf to connect starter and add-on units in corners. Connect 4 or 5 intermediate shelves between 2 starter shelves (2 sets required per shelf).



CODE	DESCRIPTION
EXCC1	1 Set for 1 shelf
EXCC4	4 Sets for 4 shelves
EXCC5	5 Sets for 5 shelves

Color: Speckled Gray (480).

Bottom Shelf Dunnage Stands

Increase weight bearing capacity on bottom shelf only. Add to any shelf length. Highly recommended for starter units 54" and longer and all corner units, intermediate units and units specified for heavier load volume on and off bottom shelves.

Bottom Shelf with Dunnage Stand

UNIT LENGTH	WEIGHT BEARING
Standard Unit	
24" - 48"	1,200 lbs.
54" - 72"	900
Corner Unit with 2 Dunnage Stands	
24" - 60"	1,200

CODE	DIMENSIONS D x H
Dunnage Stand – Low (bottom shelf installed on lowest set of open post locations for dovetails)	
EXDS14H6	14" x 6½"
EXDS18H6	18" x 6½"
EXDS21H6	21" x 6½"
EXDS24H6	24" x 6½"

Dunnage Stand – Tall (bottom shelf installed up on 2nd set of open post locations for dovetails)	
EXDS14H10	14" x 10½"
EXDS18H10	18" x 10½"
EXDS21H10	21" x 10½"
EXDS24H10	24" x 10½"

Case Pack: 1 Color: Speckled Gray (480).

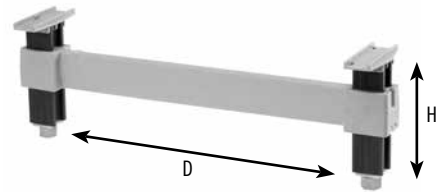

Shelf Traverses

Available in single or double packs. Use two traverses to add an open shelf for divider bars or drying cradles. Add one traverse onto back posts of a stationary unit for extra support when placing rolling equipment under the first shelf. Traverse dovetails included.

LENGTH	SINGLE PACK CODE*	DOUBLE PACK CODE**
24"	EXTR24	EXTR242PK
30"	EXTR30	EXTR302PK
36"	EXTR36	EXTR362PK
42"	EXTR42	EXTR422PK
48"	EXTR48	EXTR482PK
54"	EXTR54	EXTR542PK
60"	EXTR60	EXTR602PK
72"	EXTR72	—

*Case Pack: 1 **Case Pack: 2
Color: Speckled Gray (480).





CAMSHELVING

BASICS® PLUS

series

STATIONARY

- Posts and traverses made of a revolutionary, extremely strong, composite material with a smooth, easy to clean surface.
- Attach left and right traverse dovetails to each post to secure shelf traverses every 4".
- Removable polypropylene shelf plates with permanent, molded-in Camguard®, an antimicrobial technology that inhibits the growth of mold, fungus, and bacteria.
- Sturdy reinforced threaded nylon foot adjusts easily to level units.
- Withstands storage temperatures from -36°F to 190°F.
- Lifetime warranty against rust and corrosion.



camguard
ANTIMICROBIAL SHELF PLATES



COMPONENT

Post Connectors, Corner Connectors, Floor Fastener, Wall Fastener, Shelf Rails, Single Shelf Security Cage, Shelf Divider Panels and Identification Tags are not NSF listed.

STARTER UNITS

Ship complete in 1 box. Includes factory assembled post frames for quicker assembly.

Stationary

3 Depths			6 Lengths			3 Heights		
18"	21"	24"	30"	36"	42"	64"	72"	84"
			48"	54"	60"			

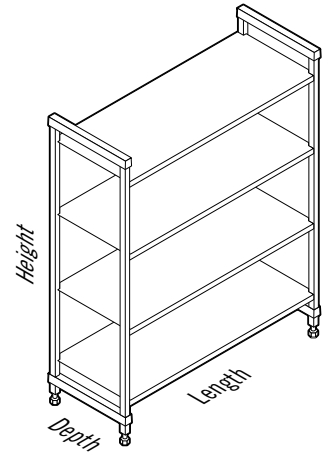

Weight Bearing Capacity

Weight must be evenly distributed across the entire shelf.

		UNIT LENGTH 30" – 48"	UNIT LENGTH 54" – 60"
SINGLE UNIT	Unit only	1,800 lbs. (TÜV)***	1,800 lbs. (TÜV)***
	Shelf only	700 (TÜV)	500 (TÜV)
	Unit with dunnage stand*	2,100	2,100
	Bottom shelf with dunnage stand*	1,000	800
CORNER UNIT** With 2 Dunnage Stands required	Unit only	1,350	—
	Shelf only	300	—
	Bottom shelf with dunnage stands*	450	—

*Dunnage Stands add stability and increase weight bearing capacity on bottom shelf only. Highly recommended for Starter Units 54" and longer, all Corner Units, U-Shape Units and units specified for heavier loads. (See Page 04-05).

**Corner connectors are for use only with shelves 30" - 48" long.

***TÜV Certification applies to Single Unit and Single Shelf only.



V4 4-Shelf Vented Units

V5 5-Shelf Vented Units

64"
HEIGHT

Starter units include 2 factory assembled post kits, 8 or 10 traverses, traverse dovetails and shelf plates.
Add-On units include 1 factory assembled post kit, 8 or 10 traverses, traverse dovetails and shelf plates.
Units ship complete in 1 box.

Starter

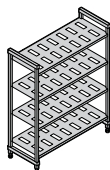

Add-On

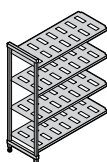

Starter

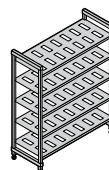

Add-On

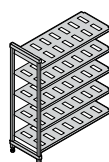

18"
DEPTH

LENGTH	CODE
30"	CBU183064V4
36"	CBU183664V4
42"	CBU184264V4
48"	CBU184864V4
54"	CBU185464V4
60"	CBU186064V4

LENGTH	CODE
28¼"	CBA183064V4
34¼"	CBA183664V4
40¼"	CBA184264V4
46¼"	CBA184864V4
52¼"	CBA185464V4
58¼"	CBA186064V4

LENGTH	CODE
30"	CBU183064V5
36"	CBU183664V5
42"	CBU184264V5
48"	CBU184864V5
54"	CBU185464V5
60"	CBU186064V5

LENGTH	CODE
28¼"	CBA183064V5
34¼"	CBA183664V5
40¼"	CBA184264V5
46¼"	CBA184864V5
52¼"	CBA185464V5
58¼"	CBA186064V5

21"
DEPTH

30"	CBU213064V4
36"	CBU213664V4
42"	CBU214264V4
48"	CBU214864V4
54"	CBU215464V4
60"	CBU216064V4

28¼"	CBA213064V4
34¼"	CBA213664V4
40¼"	CBA214264V4
46¼"	CBA214864V4
52¼"	CBA215464V4
58¼"	CBA216064V4

30"	CBU213064V5
36"	CBU213664V5
42"	CBU214264V5
48"	CBU214864V5
54"	CBU215464V5
60"	CBU216064V5

28¼"	CBA213064V5
34¼"	CBA213664V5
40¼"	CBA214264V5
46¼"	CBA214864V5
52¼"	CBA215464V5
58¼"	CBA216064V5

24"
DEPTH

30"	CBU243064V4
36"	CBU243664V4
42"	CBU244264V4
48"	CBU244864V4
54"	CBU245464V4
60"	CBU246064V4

28¼"	CBA243064V4
34¼"	CBA243664V4
40¼"	CBA244264V4
46¼"	CBA244864V4
52¼"	CBA245464V4
58¼"	CBA246064V4

30"	CBU243064V5
36"	CBU243664V5
42"	CBU244264V5
48"	CBU244864V5
54"	CBU245464V5
60"	CBU246064V5

28¼"	CBA243064V5
34¼"	CBA243664V5
40¼"	CBA244264V5
46¼"	CBA244864V5
52¼"	CBA245464V5
58¼"	CBA246064V5

S4 4-Shelf Solid Units

VS4 4-Shelf Units (3 Vented + 1 Solid Shelf)

64"
HEIGHT

Starter units include 2 factory assembled post kits, 8 traverses, traverse dovetails and shelf plates.
Add-On units include 1 factory assembled post kit, 8 traverses, traverse dovetails and shelf plates.
Units ship complete in 1 box.

Starter

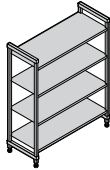

18"
DEPTH

Add-On

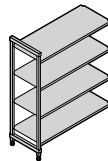

Starter

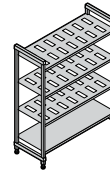

Add-On

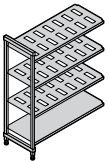

LENGTH	CODE
30"	CBU183064S4
36"	CBU183664S4
42"	CBU184264S4
48"	CBU184864S4
54"	CBU185464S4
60"	CBU186064S4

LENGTH	CODE
28¼"	CBA183064S4
34¼"	CBA183664S4
40¼"	CBA184264S4
46¼"	CBA184864S4
52¼"	CBA185464S4
58¼"	CBA186064S4

LENGTH	CODE
30"	CBU183064VS4
36"	CBU183664VS4
42"	CBU184264VS4
48"	CBU184864VS4
54"	CBU185464VS4
60"	CBU186064VS4

LENGTH	CODE
28¼"	CBA183064VS4
34¼"	CBA183664VS4
40¼"	CBA184264VS4
46¼"	CBA184864VS4
52¼"	CBA185464VS4
58¼"	CBA186064VS4

21"
DEPTH

30"	CBU213064S4
36"	CBU213664S4
42"	CBU214264S4
48"	CBU214864S4
54"	CBU215464S4
60"	CBU216064S4

28¼"	CBA213064S4
34¼"	CBA213664S4
40¼"	CBA214264S4
46¼"	CBA214864S4
52¼"	CBA215464S4
58¼"	CBA216064S4

30"	CBU213064VS4
36"	CBU213664VS4
42"	CBU214264VS4
48"	CBU214864VS4
54"	CBU215464VS4
60"	CBU216064VS4

28¼"	CBA213064VS4
34¼"	CBA213664VS4
40¼"	CBA214264VS4
46¼"	CBA214864VS4
52¼"	CBA215464VS4
58¼"	CBA216064VS4

24"
DEPTH

30"	CBU243064S4
36"	CBU243664S4
42"	CBU244264S4
48"	CBU244864S4
54"	CBU245464S4
60"	CBU246064S4

28¼"	CBA243064S4
34¼"	CBA243664S4
40¼"	CBA244264S4
46¼"	CBA244864S4
52¼"	CBA245464S4
58¼"	CBA246064S4

30"	CBU243064VS4
36"	CBU243664VS4
42"	CBU244264VS4
48"	CBU244864VS4
54"	CBU245464VS4
60"	CBU246064VS4

28¼"	CBA243064VS4
34¼"	CBA243664VS4
40¼"	CBA244264VS4
46¼"	CBA244864VS4
52¼"	CBA245464VS4
58¼"	CBA246064VS4

Color: Brushed Graphite (580).

V4 4-Shelf Vented Units

V5 5-Shelf Vented Units

72"
HEIGHT

Starter units include 2 factory assembled post kits, 8 or 10 traverses, traverse dovetails and shelf plates.
Add-On units include 1 factory assembled post kit, 8 or 10 traverses, traverse dovetails and shelf plates.
Units ship complete in 1 box.

Starter

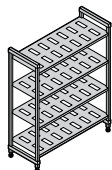

Add-On

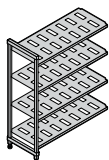

18"
DEPTH

LENGTH	CODE
30"	CBU183072V4
36"	CBU183672V4
42"	CBU184272V4
48"	CBU184872V4
54"	CBU185472V4
60"	CBU186072V4

LENGTH	CODE
28 $\frac{1}{4}$ "	CBA183072V4
34 $\frac{1}{4}$ "	CBA183672V4
40 $\frac{1}{4}$ "	CBA184272V4
46 $\frac{1}{4}$ "	CBA184872V4
52 $\frac{1}{4}$ "	CBA185472V4
58 $\frac{1}{4}$ "	CBA186072V4

Starter

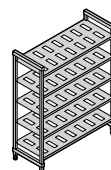

Add-On

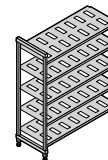

LENGTH	CODE
30"	CBU183072V5
36"	CBU183672V5
42"	CBU184272V5
48"	CBU184872V5
54"	CBU185472V5
60"	CBU186072V5

LENGTH	CODE
28 $\frac{1}{4}$ "	CBA183072V5
34 $\frac{1}{4}$ "	CBA183672V5
40 $\frac{1}{4}$ "	CBA184272V5
46 $\frac{1}{4}$ "	CBA184872V5
52 $\frac{1}{4}$ "	CBA185472V5
58 $\frac{1}{4}$ "	CBA186072V5

21"
DEPTH

30"	CBU213072V4
36"	CBU213672V4
42"	CBU214272V4
48"	CBU214872V4
54"	CBU215472V4
60"	CBU216072V4

28 $\frac{1}{4}$ "	CBA213072V4
34 $\frac{1}{4}$ "	CBA213672V4
40 $\frac{1}{4}$ "	CBA214272V4
46 $\frac{1}{4}$ "	CBA214872V4
52 $\frac{1}{4}$ "	CBA215472V4
58 $\frac{1}{4}$ "	CBA216072V4

30"	CBU213072V5
36"	CBU213672V5
42"	CBU214272V5
48"	CBU214872V5
54"	CBU215472V5
60"	CBU216072V5

28 $\frac{1}{4}$ "	CBA213072V5
34 $\frac{1}{4}$ "	CBA213672V5
40 $\frac{1}{4}$ "	CBA214272V5
46 $\frac{1}{4}$ "	CBA214872V5
52 $\frac{1}{4}$ "	CBA215472V5
58 $\frac{1}{4}$ "	CBA216072V5

24"
DEPTH

30"	CBU243072V4
36"	CBU243672V4
42"	CBU244272V4
48"	CBU244872V4
54"	CBU245472V4
60"	CBU246072V4

28 $\frac{1}{4}$ "	CBA243072V4
34 $\frac{1}{4}$ "	CBA243672V4
40 $\frac{1}{4}$ "	CBA244272V4
46 $\frac{1}{4}$ "	CBA244872V4
52 $\frac{1}{4}$ "	CBA245472V4
58 $\frac{1}{4}$ "	CBA246072V4

30"	CBU243072V5
36"	CBU243672V5
42"	CBU244272V5
48"	CBU244872V5
54"	CBU245472V5
60"	CBU246072V5

28 $\frac{1}{4}$ "	CBA243072V5
34 $\frac{1}{4}$ "	CBA243672V5
40 $\frac{1}{4}$ "	CBA244272V5
46 $\frac{1}{4}$ "	CBA244872V5
52 $\frac{1}{4}$ "	CBA245472V5
58 $\frac{1}{4}$ "	CBA246072V5

S4 4-Shelf Solid Units

VS4 4-Shelf Units (3 Vented + 1 Solid Shelf)

72"
HEIGHT

Starter units include 2 factory assembled post kits, 8 traverses, traverse dovetails and shelf plates.
Add-On units include 1 factory assembled post kit, 8 traverses, traverse dovetails and shelf plates.
Units ship complete in 1 box.

Starter

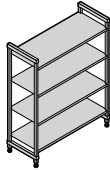

18"
DEPTH

Add-On

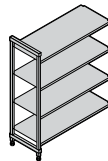

Starter

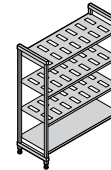

Add-On

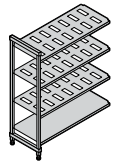

LENGTH	CODE
30"	CBU183072S4
36"	CBU183672S4
42"	CBU184272S4
48"	CBU184872S4
54"	CBU185472S4
60"	CBU186072S4

LENGTH	CODE
28¼"	CBA183072S4
34¼"	CBA183672S4
40¼"	CBA184272S4
46¼"	CBA184872S4
52¼"	CBA185472S4
58¼"	CBA186072S4

LENGTH	CODE
30"	CBU183072VS4
36"	CBU183672VS4
42"	CBU184272VS4
48"	CBU184872VS4
54"	CBU185472VS4
60"	CBU186072VS4

LENGTH	CODE
28¼"	CBA183072VS4
34¼"	CBA183672VS4
40¼"	CBA184272VS4
46¼"	CBA184872VS4
52¼"	CBA185472VS4
58¼"	CBA186072VS4

21"
DEPTH

30"	CBU213072S4
36"	CBU213672S4
42"	CBU214272S4
48"	CBU214872S4
54"	CBU215472S4
60"	CBU216072S4

28¼"	CBA213072S4
34¼"	CBA213672S4
40¼"	CBA214272S4
46¼"	CBA214872S4
52¼"	CBA215472S4
58¼"	CBA216072S4

30"	CBU213072VS4
36"	CBU213672VS4
42"	CBU214272VS4
48"	CBU214872VS4
54"	CBU215472VS4
60"	CBU216072VS4

28¼"	CBA213072VS4
34¼"	CBA213672VS4
40¼"	CBA214272VS4
46¼"	CBA214872VS4
52¼"	CBA215472VS4
58¼"	CBA216072VS4

24"
DEPTH

30"	CBU243072S4
36"	CBU243672S4
42"	CBU244272S4
48"	CBU244872S4
54"	CBU245472S4
60"	CBU246072S4

28¼"	CBA243072S4
34¼"	CBA243672S4
40¼"	CBA244272S4
46¼"	CBA244872S4
52¼"	CBA245472S4
58¼"	CBA246072S4

30"	CBU243072VS4
36"	CBU243672VS4
42"	CBU244272VS4
48"	CBU244872VS4
54"	CBU245472VS4
60"	CBU246072VS4

28¼"	CBA243072VS4
34¼"	CBA243672VS4
40¼"	CBA244272VS4
46¼"	CBA244872VS4
52¼"	CBA245472VS4
58¼"	CBA246072VS4

V4 4-Shelf Vented Units

V5 5-Shelf Vented Units

84"
HEIGHT

Starter units include 2 factory assembled post kits, 8 or 10 traverses, traverse dovetails and shelf plates.
Add-On units include 1 factory assembled post kit, 8 or 10 traverses, traverse dovetails and shelf plates.
Units ship complete in 1 box.

Starter

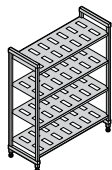

Add-On

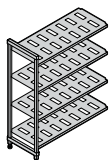

18"
DEPTH

LENGTH	CODE
30"	CBU183084V4
36"	CBU183684V4
42"	CBU184284V4
48"	CBU184884V4
54"	CBU185484V4
60"	CBU186084V4

LENGTH	CODE
28¼"	CBA183084V4
34¼"	CBA183684V4
40¼"	CBA184284V4
46¼"	CBA184884V4
52¼"	CBA185484V4
58¼"	CBA186084V4

Starter

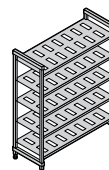

Add-On

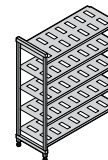

LENGTH	CODE
30"	CBU183084V5
36"	CBU183684V5
42"	CBU184284V5
48"	CBU184884V5
54"	CBU185484V5
60"	CBU186084V5

LENGTH	CODE
28¼"	CBA183084V5
34¼"	CBA183684V5
40¼"	CBA184284V5
46¼"	CBA184884V5
52¼"	CBA185484V5
58¼"	CBA186084V5

21"
DEPTH

30"	CBU213084V4
36"	CBU213684V4
42"	CBU214284V4
48"	CBU214884V4
54"	CBU215484V4
60"	CBU216084V4

28¼"	CBA213084V4
34¼"	CBA213684V4
40¼"	CBA214284V4
46¼"	CBA214884V4
52¼"	CBA215484V4
58¼"	CBA216084V4

30"	CBU213084V5
36"	CBU213684V5
42"	CBU214284V5
48"	CBU214884V5
54"	CBU215484V5
60"	CBU216084V5

28¼"	CBA213084V5
34¼"	CBA213684V5
40¼"	CBA214284V5
46¼"	CBA214884V5
52¼"	CBA215484V5
58¼"	CBA216084V5

24"
DEPTH

30"	CBU243084V4
36"	CBU243684V4
42"	CBU244284V4
48"	CBU244884V4
54"	CBU245484V4
60"	CBU246084V4

28¼"	CBA243084V4
34¼"	CBA243684V4
40¼"	CBA244284V4
46¼"	CBA244884V4
52¼"	CBA245484V4
58¼"	CBA246084V4

30"	CBU243084V5
36"	CBU243684V5
42"	CBU244284V5
48"	CBU244884V5
54"	CBU245484V5
60"	CBU246084V5

28¼"	CBA243084V5
34¼"	CBA243684V5
40¼"	CBA244284V5
46¼"	CBA244884V5
52¼"	CBA245484V5
58¼"	CBA246084V5

S4 4-Shelf Solid Units

S5 5-Shelf Solid Units

84"
HEIGHT

Starter units include 2 factory assembled post kits, 8 or 10 traverses, traverse dovetails and shelf plates.
Add-On units include 1 factory assembled post kit, 8 or 10 traverses, traverse dovetails and shelf plates.
Units ship complete in 1 box.

Starter

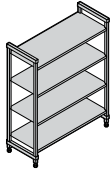

18"
DEPTH

Add-On

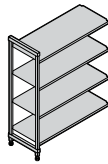

LENGTH	CODE
30"	CBU183084S4
36"	CBU183684S4
42"	CBU184284S4
48"	CBU184884S4
54"	CBU185484S4
60"	CBU186084S4

LENGTH	CODE
28¼"	CBA183084S4
34¼"	CBA183684S4
40¼"	CBA184284S4
46¼"	CBA184884S4
52¼"	CBA185484S4
58¼"	CBA186084S4

Starter

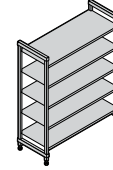

LENGTH	CODE
30"	CBU183084S5
36"	CBU183684S5
42"	CBU184284S5
48"	CBU184884S5
54"	CBU185484S5
60"	CBU186084S5

Add-On

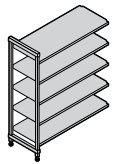

LENGTH	CODE
28¼"	CBA183084S5
34¼"	CBA183684S5
40¼"	CBA184284S5
46¼"	CBA184884S5
52¼"	CBA185484S5
58¼"	CBA186084S5

21"
DEPTH

30"	CBU213084S4
36"	CBU213684S4
42"	CBU214284S4
48"	CBU214884S4
54"	CBU215484S4
60"	CBU216084S4

28¼"	CBA213084S4
34¼"	CBA213684S4
40¼"	CBA214284S4
46¼"	CBA214884S4
52¼"	CBA215484S4
58¼"	CBA216084S4

30"	CBU213084S5
36"	CBU213684S5
42"	CBU214284S5
48"	CBU214884S5
54"	CBU215484S5
60"	CBU216084S5

28¼"	CBA213084S5
34¼"	CBA213684S5
40¼"	CBA214284S5
46¼"	CBA214884S5
52¼"	CBA215484S5
58¼"	CBA216084S5

24"
DEPTH

30"	CBU243084S4
36"	CBU243684S4
42"	CBU244284S4
48"	CBU244884S4
54"	CBU245484S4
60"	CBU246084S4

28¼"	CBA243084S4
34¼"	CBA243684S4
40¼"	CBA244284S4
46¼"	CBA244884S4
52¼"	CBA245484S4
58¼"	CBA246084S4

30"	CBU243084S5
36"	CBU243684S5
42"	CBU244284S5
48"	CBU244884S5
54"	CBU245484S5
60"	CBU246084S5

28¼"	CBA243084S5
34¼"	CBA243684S5
40¼"	CBA244284S5
46¼"	CBA244884S5
52¼"	CBA245484S5
58¼"	CBA246084S5

VS4 4-Shelf Units

(3 Vented + 1 Solid Shelf)

84"
HEIGHT

Starter units include 2 factory assembled post kits, 8 or 10 traverses, traverse dovetails and shelf plates.
Add-On units include 1 factory assembled post kit, 8 or 10 traverses, traverse dovetails and shelf plates.
Units ship complete in 1 box.

Starter

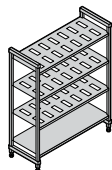

Add-On

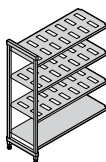

18"
DEPTH

LENGTH	CODE
30"	CBU183084VS4
36"	CBU183684VS4
42"	CBU184284VS4
48"	CBU184884VS4
54"	CBU185484VS4
60"	CBU186084VS4

LENGTH	CODE
28¼"	CBA183084VS4
34¼"	CBA183684VS4
40¼"	CBA184284VS4
46¼"	CBA184884VS4
52¼"	CBA185484VS4
58¼"	CBA186084VS4

Starter

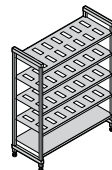

Add-On

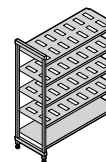

LENGTH	CODE
30"	CBU183084VS5
36"	CBU183684VS5
42"	CBU184284VS5
48"	CBU184884VS5
54"	CBU185484VS5
60"	CBU186084VS5

LENGTH	CODE
28¼"	CBA183084VS5
34¼"	CBA183684VS5
40¼"	CBA184284VS5
46¼"	CBA184884VS5
52¼"	CBA185484VS5
58¼"	CBA186084VS5

21"
DEPTH

30"	CBU213084VS4
36"	CBU213684VS4
42"	CBU214284VS4
48"	CBU214884VS4
54"	CBU215484VS4
60"	CBU216084VS4

28¼"	CBA213084VS4
34¼"	CBA213684VS4
40¼"	CBA214284VS4
46¼"	CBA214884VS4
52¼"	CBA215484VS4
58¼"	CBA216084VS4

30"	CBU213084VS5
36"	CBU213684VS5
42"	CBU214284VS5
48"	CBU214884VS5
54"	CBU215484VS5
60"	CBU216084VS5

28¼"	CBA213084VS5
34¼"	CBA213684VS5
40¼"	CBA214284VS5
46¼"	CBA214884VS5
52¼"	CBA215484VS5
58¼"	CBA216084VS5

24"
DEPTH

30"	CBU243084VS4
36"	CBU243684VS4
42"	CBU244284VS4
48"	CBU244884VS4
54"	CBU245484VS4
60"	CBU246084VS4

28¼"	CBA243084VS4
34¼"	CBA243684VS4
40¼"	CBA244284VS4
46¼"	CBA244884VS4
52¼"	CBA245484VS4
58¼"	CBA246084VS4

30"	CBU243084VS5
36"	CBU243684VS5
42"	CBU244284VS5
48"	CBU244884VS5
54"	CBU245484VS5
60"	CBU246084VS5

28¼"	CBA243084VS5
34¼"	CBA243684VS5
40¼"	CBA244284VS5
46¼"	CBA244884VS5
52¼"	CBA245484VS5
58¼"	CBA246084VS5

Stationary Post Kits

Includes 2 stationary posts, 1 top and bottom post connector and post connector wedges. Ships unassembled in 1 box.

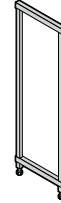

64"
HEIGHT

CODE	DIMENSIONS D x H
CBPK1864	18" x 64"
CBPK2164	21" x 64"
CBPK2464	24" x 64"

72"
HEIGHT

CBPK1872	18" x 72"
CBPK2172	21" x 72"
CBPK2472	24" x 72"

84"
HEIGHT

CBPK1884	18" x 84"
CBPK2184	21" x 84"
CBPK2484	24" x 84"



Color: Brushed Graphite (580).

V1 Single Vented Shelf Kits

S1 Single Solid Shelf Kits

Includes 2 shelf traverses, traverse dovetails and vented or solid shelf plates. Ships in 1 box.

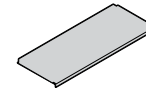
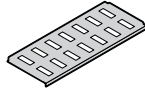

18"
DEPTH

CODE	DIMENSIONS D x L
CBSK1830V1	18" x 30"
CBSK1836V1	18" x 36"
CBSK1842V1	18" x 42"
CBSK1848V1	18" x 48"
CBSK1854V1	18" x 54"
CBSK1860V1	18" x 60"

18"
DEPTH

CODE	DIMENSIONS D x L
CBSK1830S1	18" x 30"
CBSK1836S1	18" x 36"
CBSK1842S1	18" x 42"
CBSK1848S1	18" x 48"
CBSK1854S1	18" x 54"
CBSK1860S1	18" x 60"

21"
DEPTH

CBSK2130V1	21" x 30"
CBSK2136V1	21" x 36"
CBSK2142V1	21" x 42"
CBSK2148V1	21" x 48"
CBSK2154V1	21" x 54"
CBSK2160V1	21" x 60"

21"
DEPTH

CBSK2130S1	21" x 30"
CBSK2136S1	21" x 36"
CBSK2142S1	21" x 42"
CBSK2148S1	21" x 48"
CBSK2154S1	21" x 54"
CBSK2160S1	21" x 60"

24"
DEPTH

CBSK2430V1	24" x 30"
CBSK2436V1	24" x 36"
CBSK2442V1	24" x 42"
CBSK2448V1	24" x 48"
CBSK2454V1	24" x 54"
CBSK2460V1	24" x 60"

24"
DEPTH

CBSK2430S1	24" x 30"
CBSK2436S1	24" x 36"
CBSK2442S1	24" x 42"
CBSK2448S1	24" x 48"
CBSK2454S1	24" x 54"
CBSK2460S1	24" x 60"

V4 4-Shelf Vented Kits

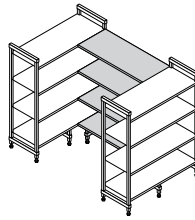

S4 4-Shelf Solid Kits

Includes 8 shelf traverses, traverse dovetails and vented or solid shelf plates.
Ships in 1 box. Install with 8 sets of corner connectors (CBCC8) to create a U-shape unit.

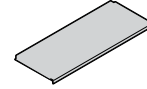
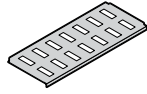

18"
DEPTH

CODE	DIMENSIONS D x L
CBSK1836V4	18" x 36"
CBSK1842V4	18" x 42"
CBSK1848V4	18" x 48"

18"
DEPTH

CODE	DIMENSIONS D x L
CBSK1836S4	18" x 36"
CBSK1842S4	18" x 42"
CBSK1848S4	18" x 48"

21"
DEPTH

CBSK2136V4	21" x 36"
CBSK2142V4	21" x 42"
CBSK2148V4	21" x 48"

21"
DEPTH

CBSK2136S4	21" x 36"
CBSK2142S4	21" x 42"
CBSK2148S4	21" x 48"

24"
DEPTH

CBSK2436V4	24" x 36"
CBSK2442V4	24" x 42"
CBSK2448V4	24" x 48"

24"
DEPTH

CBSK2436S4	24" x 36"
CBSK2442S4	24" x 42"
CBSK2448S4	24" x 48"

V5 5-Shelf Vented Kits

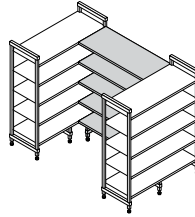

S5 5-Shelf Solid Kits

Includes 10 shelf traverses, traverse dovetails and vented or solid shelf plates.
Ships in 1 box. Install with 10 sets of corner connectors (CBCC10) to create a U-shape unit.

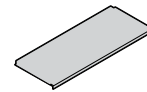
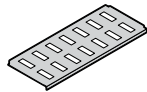

18"
DEPTH

CODE	DIMENSIONS D x L
CBSK1836V5	18" x 36"
CBSK1842V5	18" x 42"
CBSK1848V5	18" x 48"

18"
DEPTH

CODE	DIMENSIONS D x L
CBSK1836S5	18" x 36"
CBSK1842S5	18" x 42"
CBSK1848S5	18" x 48"

21"
DEPTH

CBSK2136V5	21" x 36"
CBSK2142V5	21" x 42"
CBSK2148V5	21" x 48"

21"
DEPTH

CBSK2136S5	21" x 36"
CBSK2142S5	21" x 42"
CBSK2148S5	21" x 48"

24"
DEPTH

CBSK2436V5	24" x 36"
CBSK2442V5	24" x 42"
CBSK2448V5	24" x 48"

24"
DEPTH

CBSK2436S5	24" x 36"
CBSK2442S5	24" x 42"
CBSK2448S5	24" x 48"

Color: Brushed Graphite (580).

VS4

4-Shelf Kits

(3 Vented + 1 Solid)

Includes 8 shelf traverses, traverse dovetails and vented and solid shelf plates. Ships in 1 box. Install with 8 sets of corner connectors (CBCC8) to create a U-shape unit.

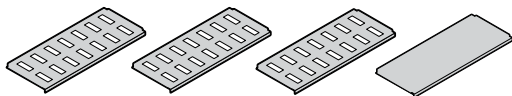

18"
DEPTH

CODE	DIMENSIONS D x L
CBSK1836VS4	18" x 36"
CBSK1842VS4	18" x 42"
CBSK1848VS4	18" x 48"

21"
DEPTH

CBSK2136VS4	21" x 36"
CBSK2142VS4	21" x 42"
CBSK2148VS4	21" x 48"

24"
DEPTH

CBSK2436VS4	24" x 36"
CBSK2442VS4	24" x 42"
CBSK2448VS4	24" x 48"

VS5

5-Shelf Kits

(4 Vented + 1 Solid)

Includes 10 shelf traverses, traverse dovetails and vented and solid shelf plates. Ships in 1 box. Install with 10 sets of corner connectors (CBCC10) to create a U-shape unit.

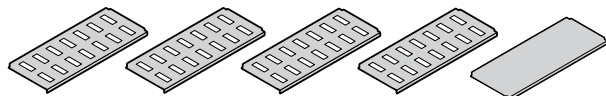

18"
DEPTH

CODE	DIMENSIONS D x L
CBSK1836VS5	18" x 36"
CBSK1842VS5	18" x 42"
CBSK1848VS5	18" x 48"

21"
DEPTH

CBSK2136VS5	21" x 36"
CBSK2142VS5	21" x 42"
CBSK2148VS5	21" x 48"

24"
DEPTH

CBSK2436VS5	24" x 36"
CBSK2442VS5	24" x 42"
CBSK2448VS5	24" x 48"

Color: Brushed Graphite (580).



Corner Connectors

For use only with shelves 30" - 48" long. Unique patented design ensures maximum shelf space utilization. Use 1 set per shelf to connect starter and add-on units in corners. Connect 4 or 5 intermediate shelves between 2 starter units (2 sets required per shelf).

CODE	DESCRIPTION
CBCC1	1 Set for 1 Shelf
CBCC8	8 Sets for 4 Shelves
CBCC10	10 Sets for 5 Shelves

Color: Brushed Graphite (580).

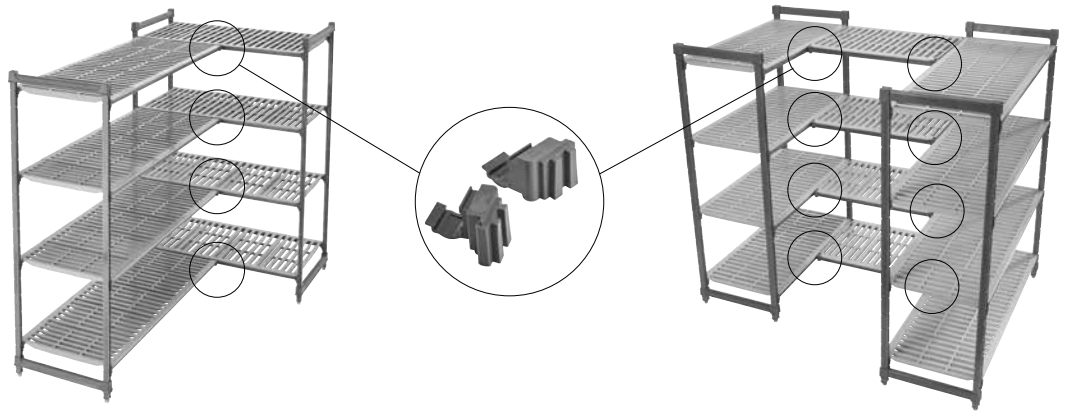

Bottom Shelf Dunnage Stands

Increase weight bearing capacity on bottom shelf only. Add to any shelf length. Highly recommended for starter units 54" and longer and all corner units, intermediate units and units specified for heavier load volume on and off bottom shelves.

Bottom Shelf with Dunnage Stand

UNIT LENGTH	WEIGHT BEARING
Standard Unit	
30" - 48"	1,000 lbs.
54" - 60"	800
Corner Unit with 2 Dunnage Stands	
30" - 48"	450

CODE	DIMENSIONS D x H
Dunnage Stand – Low (bottom shelf installed on lowest set of open post locations for dovetails)	
CBDS18H6	18" x 6¾"
CBDS21H6	21" x 6¾"
CBDS24H6	24" x 6¾"
Dunnage Stand – Tall (bottom shelf installed up on 2nd set of open post locations for dovetails)	
CBDS18H10	18" x 10¾"
CBDS21H10	21" x 10¾"
CBDS24H10	24" x 10¾"

Case Pack: 1 Color: Brushed Graphite (580).

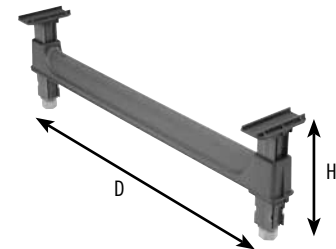

Shelf Traverses

Add single traverse on the back of a stationary unit for extra support when significant space is required between the bottom and second shelf or when placing rolling equipment under the first shelf. Traverse dovetails included.

LENGTH	SINGLE PACK CODE*	DOUBLE PACK CODE**
30"	CBTR30	CBTR302PK
36"	CBTR36	CBTR362PK
42"	CBTR42	CBTR422PK
48"	CBTR48	CBTR482PK
54"	CBTR54	CBTR542PK
60"	CBTR60	CBTR602PK

*Case Pack: 1 **Case Pack: 2 Color: Brushed Graphite (580).



CAMSHELVING® ACCESSORIES

Shelf Rail Kits

Use to prevent contents from falling off shelves. Protect individual sides or ends or wrap a full shelf. Rods are made from a strong composite material that is highly durable and will never rust or corrode. Fits shelving units 24" to 72" long and 14" to 24" deep.



Full Shelf Rail Kits

(Includes 2 sides and 2 ends in 1 box)

14" DEPTH	SHELF LENGTH	24"	30"	36"	42"	48"	54"	60"	72"
	PREMIUM	CPR1424	CPR1430	CPR1436	CPR1442	CPR1448	CPR1454	CPR1460	CPR1472
ELEMENTS XTRA	ESR1424	ESR1430	ESR1436	ESR1442	ESR1448	ESR1454	ESR1460	ESR1472	
18" DEPTH	PREMIUM	CPR1824	CPR1830	CPR1836	CPR1842	CPR1848	CPR1854	CPR1860	CPR1872
	ELEMENTS XTRA	ESR1824	ESR1830	ESR1836	ESR1842	ESR1848	ESR1854	ESR1860	ESR1872
	BASICS PLUS	—	CBR1830	CBR1836	CBR1842	CBR1848	CBR1854	CBR1860	—
21" DEPTH	PREMIUM	CPR2124	CPR2130	CPR2136	CPR2142	CPR2148	CPR2154	CPR2160	CPR2172
	ELEMENTS XTRA	ESR2124	ESR2130	ESR2136	ESR2142	ESR2148	ESR2154	ESR2160	ESR2172
	BASICS PLUS	—	CBR2130	CBR2136	CBR2142	CBR2148	CBR2154	CBR2160	—
24" DEPTH	PREMIUM	CPR2424	CPR2430	CPR2436	CPR2442	CPR2448	CPR2454	CPR2460	CPR2472
	ELEMENTS XTRA	ESR2424	ESR2430	ESR2436	ESR2442	ESR2448	ESR2454	ESR2460	ESR2472
	BASICS PLUS	—	CBR2430	CBR2436	CBR2442	CBR2448	CBR2454	CBR2460	—

Case Pack: 1 kit Color: Soft Gray (151).

Three-Quarter Shelf Rail Kits

(Includes 1 back side and 2 ends in 1 box)

14" DEPTH	SHELF LENGTH	24"	30"	36"	42"	48"	54"	60"	72"
	PREMIUM	CPR14243	CPR14303	CPR14363	CPR14423	CPR14483	CPR14543	CPR14603	CPR14723
ELEMENTS XTRA	ESR14243	ESR14303	ESR14363	ESR14423	ESR14483	ESR14543	ESR14603	ESR14723	
18" DEPTH	PREMIUM	CPR18243	CPR18303	CPR18363	CPR18423	CPR18483	CPR18543	CPR18603	CPR18723
	ELEMENTS XTRA	ESR18243	ESR18303	ESR18363	ESR18423	ESR18483	ESR18543	ESR18603	ESR18723
	BASICS PLUS	—	CBR18303	CBR18363	CBR18423	CBR18483	CBR18543	CBR18603	—
21" DEPTH	PREMIUM	CPR21243	CPR21303	CPR21363	CPR21423	CPR21483	CPR21543	CPR21603	CPR21723
	ELEMENTS XTRA	ESR21243	ESR21303	ESR21363	ESR21423	ESR21483	ESR21543	ESR21603	ESR21723
	BASICS PLUS	—	CBR21303	CBR21363	CBR21423	CBR21483	CBR21543	CBR21603	—
24" DEPTH	PREMIUM	CPR24243	CPR24303	CPR24363	CPR24423	CPR24483	CPR24543	CPR24603	CPR24723
	ELEMENTS XTRA	ESR24243	ESR24303	ESR24363	ESR24423	ESR24483	ESR24543	ESR24603	ESR24723
	BASICS PLUS	—	CBR24303	CBR24363	CBR24423	CBR24483	CBR24543	CBR24603	—

Case Pack: 1 kit Color: Soft Gray (151).

One Side Rail Kits

PREMIUM	ELEMENTS XTRA	BASICS PLUS	LENGTH
CPR24S	ESR24S	—	24"
CPR30S	ESR30S	CBR30S	30"
CPR36S	ESR36S	CBR36S	36"
CPR42S	ESR42S	CBR42S	42"
CPR48S	ESR48S	CBR48S	48"
CPR54S	ESR54S	CBR54S	54"
CPR60S	ESR60S	CBR60S	60"
CPR72S	ESR72S	—	72"

Case Pack: 1 Color: Soft Gray (151).

One End Rail Kits

PREMIUM	ELEMENTS XTRA	BASICS PLUS	DEPTH
CPR14E	ESR14E	—	14"
CPR18E	ESR18E	CBR18E	18"
CPR21E	ESR21E	CBR21E	21"
CPR24E	ESR24E	CBR24E	24"

Case Pack: 1 Color: Soft Gray (151).

CAMSHELVING® ACCESSORIES

Wall Fastener

Use to secure stationary shelving unit to a wall for added safety and stability where required. Made of 300 series, 11 gauge stainless steel. Screws not included.

CODE	DIMENSION D x L x H
Premium®, Elements® XTRA & Basics® Plus Series	
CSWF	2 7/8" x 9 7/8" x 1 7/8"
Case Pack: 4 Color: Silver (000).	



Hole diameter 7/16".



Floor Fasteners

Secure stationary unit posts directly to the floor for added safety and stability where required. Made of 300 series, 11 gauge stainless steel. Bolts not included.

CODE	DIMENSION D x L x H*
Stationary	
CSFF	1 1/2" x 6 1/2" x 3 3/4"
High Density	
CSHDF	1 3/8" x 4 1/4" x 1 1/2"

CSFF Case Pack: 2 CSHDF Case Pack: 4
Color: Silver (000).
 *Height of CSFF includes stainless steel leveling foot.



Hole diameter 9/16".

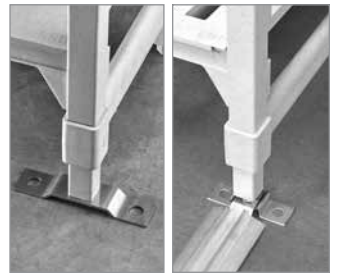

CAMSHELVING® ACCESSORIES

Ultimate Sheet Pan Rack for Single Shelf

- Fits 24" or 21" deep vented or solid shelves.
- Holds 6 full size or 12 half size sheet pans.
- Holds up to 40 lbs. per rail set with maximum weight bearing of 200 lbs. per rack.
- Rails are heat tolerant and will accept pans out of the oven up to 350°F.
- Secure racks to shelving unit with 2 post clips, installed on front and back.
- Installation requires 5 open molded in dovetails or dovetail notches between shelves.
- Lifetime warranty against rust and corrosion.
- Ships knockdown.

CODE	DIMENSION D x L x H
Premium or Elements XTRA Series	
CSUPR1826S6	24 1/8" x 20 1/2" x 20 1/4"
Basics Plus Series	
CBUPR1826S6	24 1/8" x 20 1/2" x 20 1/4"
Case Pack: 1 Color: Brushed Graphite (580). Patent Applied For.	



Scan for
Racks Per
Shelf Guide



CAMSHELVING® ACCESSORIES

Universal Storage Rack

Create individual storage sections by installing rail panels onto shelf traverses. Install on new or existing units in kitchens, coolers, freezers, or dry storage. Holds everything – trays, sheet pans, food pans, pizza dough boxes and food boxes. Fits Camshelving only with kits available for all lines. Seven rails per panel, double sided with 2" rail spacing. Temperature tolerance -40°F to 350°F. Each rail set holds up to 30 lbs. Maximum weight load is 120 lbs. per storage section.



Fresh Herbs



Pizza Dough

**Transform
YOUR Storage**

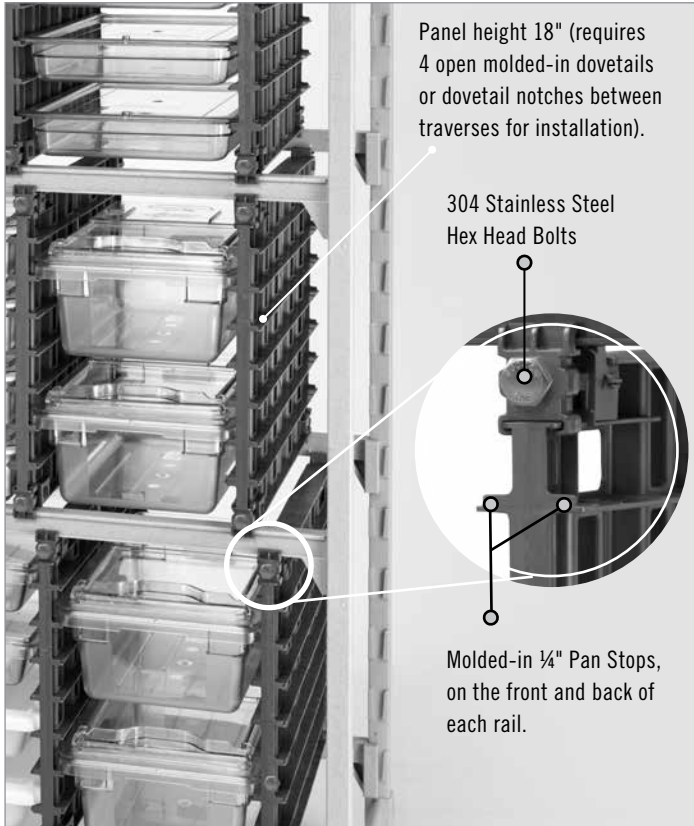

Panel height 18" (requires 4 open molded-in dovetails or dovetail notches between traverses for installation).

304 Stainless Steel Hex Head Bolts

Molded-in ¼" Pan Stops, on the front and back of each rail.



Shown Installed on Premium Series Shelving Unit: 24" x 54" x 72"

Kit Contents

Starter Kit

- 2 Rail Panels
- 8 Panel Bracket Sets
- 8 Traverse Brackets
- 8 Hex Head Bolts

Add-On Kit

- 1 Rail Panel
- 4 Panel Bracket Sets
- 4 Traverse Brackets
- 4 Hex Head Bolts



Scan Here for Storage Configurator

For Premium®/Elements® XTRA Series

PRODUCT CODE	DESCRIPTION	FITS SHELVING
CSUNVR21	Starter Kit	21" Deep
CSUNVRA21	Add-On Kit	21" Deep
CSUNVR24	Starter Kit	24" Deep
CSUNVRA24	Add-On Kit	24" Deep

Case Pack: 1 Color: Brushed Graphite (580).

For Basics Plus® Series

PRODUCT CODE	DESCRIPTION	FITS SHELVING
CBUNVR21	Starter Kit	21" Deep
CBUNVRA21	Add-On Kit	21" Deep
CBUNVR24	Starter Kit	24" Deep
CBUNVRA24	Add-On Kit	24" Deep

Case Pack: 1 Color: Brushed Graphite (580).

CAMSHELVING® ACCESSORIES

Identification Tags

Clip onto shelf traverses to clearly identify stored product. Made of highly durable plastic with a clear slide in front panel. 14 labels included: 12 color-coded, pre-printed and 2 blank.

CODE	DESCRIPTION	DIMENSION L x H
Premium® and Elements® XTRA Series		
CSID6	6" ID Tag	6" x 1"
CSID3	3" ID Tag	3" x 1"
Basics® Plus Series		
CBID6	6" ID Tag	6" x 1"

Case Pack: 12 **Color:** White / Clear.
Pre-printed, color labels, 2 each: Blue - Cooked Foods, Beige - Fish, Yellow - Poultry, White - Dairy, Green - Fruits and Vegetables, Red - Raw Meat.



Shelf Divider Bars

Create a custom service or storage station for food pans, boxes or dish racks. Install straight or angled dividers directly onto shelf traverses. Install 2 dividers between storage products. Fits 24" deep shelf only.

CODE	DESCRIPTION
Premium® Series	
CSDBA	Angled Divider Bar
CSDBS	Straight Divider Bar
Elements® XTRA Series	
EDBA	Angled Divider Bar
EDBS	Straight Divider Bar

Case Pack: 4 **Color:** Speckled Gray (480).

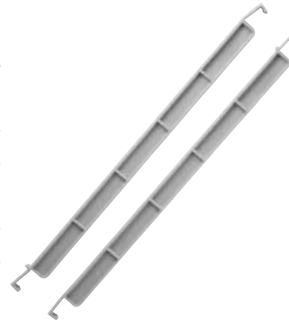

Shelf Divider Panel

Made of highly durable plastic. Installs directly onto solid or vented shelves. Easily removable for relocating or washing. Use with Shelf Rails to prevent contents from falling off shelves. Can be installed on shelves inside Full Wrap Security Cage units.

CODE	DIMENSION D x H
Premium, Elements XTRA & Basics® Plus Series	
CSSD188	18" x 8"
CSSD218	21" x 8"
CSSD248	24" x 8"

Case Pack: 1 **Color:** Soft Gray (151).



Pegboard Storage System

Use to dry, store, and organize light duty products such as lids, drain shelves, tongs, spoons, ladles, mixer paddles, or spatulas. Made of heavy-duty ¼" thick, commercial grade ABS plastic with stainless steel hardware. Includes 12 each double locking 6" straight hooks. Install on the end of 18", 21" or 24" deep Camshelving units or on the wall. Maximum weight bearing per hook is 15 lbs. Per unit is 150 lbs.

CODE	DESCRIPTION	DIMENSION W x D x H
CSPEGKIT18	Pegboard Kit, 18" x 48"	16¾" x 48" x ¼"
CSPEGKIT21	Pegboard Kit, 21" x 48"	19¾" x 48" x ¼"
CSPEGKIT24	Pegboard Kit, 24" x 48"	22¾" x 48" x ¼"
CSPEGKITW	Pegboard Wall Mount Kit	—
CSPEGH6*	Pegboard 6" Peg Hooks 12 each	—

Case Pack: 1 ***Case Pack:** 12 **Pegboard Kit Color:** Black (110).
Wall Mount Kit and Pegboard Hook Color: Stainless Steel (000).
 **Sold by the case only. No broken cartons.

Pegboard Kits include 1 Pegboard, 8 Post screws, 1 Drill bit, and 12 Hooks and screws. Wall Mount Kit includes 8 Wall mount screws, 8 Plastic wall anchors, and 8 Wall mount spacers. Peg Hook Kit includes 12 Hooks and screws.

NOTE: Pegboard does NOT fit Camshelving Premium® Series, 32" or 54" high Stationary Units or 35" or 57" high Mobile Units due to the pegboard panel overlapping the available open-end space.

Kits ship in

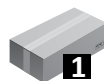

Unique double locking, 6" straight stainless steel pegboard hook features bottom locking tab and top stainless steel screw for extra holding strength and superior stability.

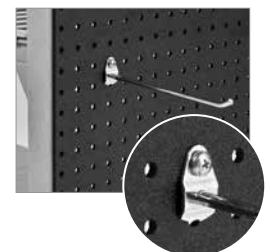

ULTIMATE FOOD PAN TROLLEYS AND SHEET PAN RACKS

- Made from extremely strong, highly durable, composite plastic materials.
- Use in coolers, freezers or dry storage.
- Heat tolerant rails accept hot pans from oven up to 390°F on Trolleys and up to 350°F on Sheet Pan Racks.
- No metal welds, screws or cross bars that can dent, break, bend, rust or corrode.
- Premium swivel plastic casters, all with total locking brake that locks both swivel and wheel. Non-marking thermoplastic rubber wheel.
- Lifetime warranty against rust and corrosion from top to bottom.

GN Food Pan Trolleys



MOLDED IN PAN STOPS

0.12" on each rail end provides stability during transporting.

Ultimate Sheet Pan Racks

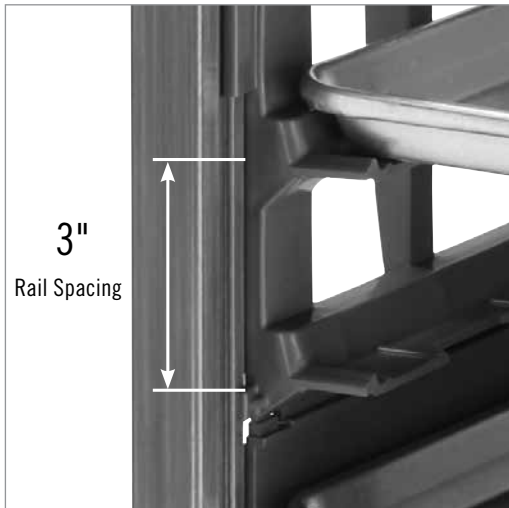

MOLDED IN RAIL RIBS AND ENDS

For quicker cool down of sheet pans and centering pans on rails.



ULTIMATE FOOD PAN TROLLEYS



GN 1/1 Food Pan Trolleys Standard Capacity

1 Full Size Food Pan
per Rail Set

CODE	UGNPR11F18	UGNPR11H9
DESCRIPTION	Full Size Trolley	Half Size Trolley
HOLDING CAPACITY	18 GN 1/1 Food Pans	9 GN 1/1 Food Pans
DIMENSION D x W x H	28¾" x 17¼" x 67⅞"	28¾" x 17¼" x 40"
UNIT WEIGHT	53.15 lbs.	32.68 lbs.
UNIT WEIGHT-BEARING CAPACITY 40 lbs. per Rail Set	750 lbs.	375 lbs.

Color: Speckled Gray (480). **Casters:** 4 each 5" swivel casters with total locking brake.

GN 2/1 Food Pan Trolleys High-Volume Capacity

2 Full Size Food Pans
per Rail Set

CODE	UGNPR21F36	UPNGR21H18
DESCRIPTION	Full Size Trolley	Half Size Trolley
HOLDING CAPACITY	36 GN 1/1 Food Pans	18 GN 1/1 Food Pans
DIMENSION D x W x H	32⅞" x 25⅜" x 67⅞"	32⅞" x 25⅜" x 40"
UNIT WEIGHT	60.9 lbs.	37.7 lbs.
UNIT WEIGHT-BEARING CAPACITY 80 lbs. per Rail Set	750 lbs.	375 lbs.

Color: Speckled Gray (480). **Casters:** 4 each 5" swivel casters with total locking brake.



Pan Stops



UGNPRPSF
For Full Size Trolleys

UGNPRPSH
For Half Size Trolleys

Color: Speckled Gray (480).

Covers



GBCTUGNPR11
For Full Size GN 1/1 Trolley
26" x 18⅞" x 60⅞"

GBCTUGNPR21
For Full Size GN 2/1 Trolley
31" x 26¼" x 60⅞"



Lifetime warranty
against rust and corrosion

KD

All Trolleys
ship knockdown in
1 box

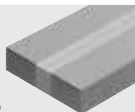

ULTIMATE SHEET PAN RACKS

Full Size

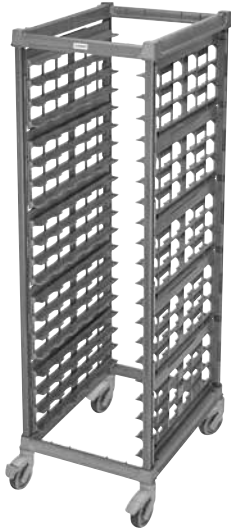

CODE	UPR1826FP20	UPR1826FP40
Knockdown (KD) Units		
DESCRIPTION	Full Size	Full Size
HOLDING CAPACITY	20 Sheet pans/trays	40 Sheet pans/trays
RAIL SPACING	3"	1½"
DIMENSION D x W x H	33¾" x 25⅞" x 72¾"	33¾" x 25⅞" x 72¾"
UNIT WEIGHT	50.2 lbs.	56.6 lbs.
WEIGHT-BEARING CAPACITY 55 lbs. per Rail Set	350 lbs.	350 lbs.

Color: Brushed Graphite (580). *Dimensions include 5" plastic casters.

CODE	UPR1826FPA20	UPR1826FPA40
Factory Assembled (FA) Units		
DESCRIPTION	Full Size	Full Size
HOLDING CAPACITY	20 Sheet pans/trays	40 Sheet pans/trays
RAIL SPACING	3"	1½"
DIMENSION D x W x H	33¾" x 25⅞" x 72¾"	33¾" x 25⅞" x 72¾"
UNIT WEIGHT	46.1 lbs.	56.6 lbs.
WEIGHT-BEARING CAPACITY 55 lbs. per Rail Set	350 lbs.	350 lbs.

Color: Brushed Graphite (580). *Dimensions include 5" plastic casters.

Half Size

CODE	UPR1826HP12	UPR1826HP20
DESCRIPTION	Half Size	Half Size
HOLDING CAPACITY	12 Sheet pans/trays	20 Sheet pans/trays
RAIL SPACING	3"	1½"
DIMENSION D x W x H	78,3 x 51,6 x 170,8 cm	78,3 x 51,6 x 101,4 cm
UNIT WEIGHT	34 lbs.	34 lbs.
WEIGHT-BEARING CAPACITY 55 lbs. per Rail Set	175 lbs.	175 lbs.

Color: Brushed Graphite (580). *Dimensions include 5" plastic casters.



**Full and Half Size Units also available with zinc plated metal casters. For more information about units with metal casters contact your Distributor, Cambro Sales Representative or the Cambro Customer Service Department.

Undercounter



CODE	UPR1826U8	UPR1826U15
DESCRIPTION	Undercounter	Undercounter
HOLDING CAPACITY	8 Sheet pans/trays	15 Sheet pans/trays
RAIL SPACING	3"	1½"
DIMENSION D x W x H	78,3 x 51,6 x 170,8 cm	78,3 x 51,6 x 101,4 cm
UNIT WEIGHT	27 lbs.	27 lbs.
WEIGHT-BEARING CAPACITY 55 lbs. per Rail Set	90 lbs.	90 lbs.

Color: Brushed Graphite (580). *Dimensions include 3" metal casters.

Pan Stops



UPRPSF
For Full Size Sheet Pan Racks

UPRPSH
For Half Size Sheet Pan Racks

Color: Brushed Graphite (580).

Covers



GBCTUPR
Vinyl Cover
30" x 24" x 65"
Color: Opaque (CLR).

GBIRC272162
Insulated Cover
27½" x 21½" x 62"
Color: Black (110).



**Lifetime warranty
against rust and corrosion**

PREMIUM® SERIES DRYING AND STORAGE RACKS

- Promotes sanitary air drying and minimizes handling.
- Efficient, high capacity storage in a compact footprint.
- Lifetime warranty against rust and corrosion.
- Cradles are made of highly durable ABS plastic.
- Will never bend or dent. Easy to clean and maintain.
- Racks ship knockdown with factory assembled post kits.
- Premium swivel plastic casters with total locking brake – locks both swivel and wheel.



Premium® Series Vertical Drying and Storage Racks

- For trays, sheet pans, lids and small cutting boards.
- Cradle slot is 1 5/16" wide. Dividers are 2 1/2" high.



CSDR7



CODE	DIMENSIONS D x L x H*	HOLDING CAPACITY	CASE PACK
Premium Series Vertical Drying and Storage Rack			
CPMU244875DRPKG	24" x 48" x 75"	84 Trays	1
CPMU246075DRPKG	24" x 60" x 75"	105 Trays	1
Vertical Drying and Storage Cradle for 24" deep shelf only (Fits all Camshelving® lines)			
CSDR7	23½" x 10¼" x 3¾"	—	1
CSDR73	23½" x 10¼" x 3¾"	—	3

Drying Rack Color: Speckled Gray (480). **Drying Cradle Color:** Soft Gray (151).

*Rack height includes 5" casters.

48" long unit ships in  5

60" long unit ships in  6

PREMIUM® SERIES DRYING AND STORAGE RACKS

Premium Series Angled Drying and Storage Rack

- For meal delivery pellets, storage containers, food pans, pots and pans.
- Cradle slot is 2 3/8" wide.

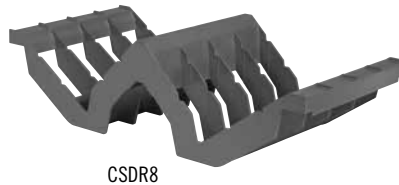

CSDR8



CODE	DIMENSIONS D x L x H*	HOLDING CAPACITY	CASE PACK
Premium Series Angled Drying and Storage Rack			
CPMU244875PDPKG	24" x 48" x 75"	128 Pellets and Bases or 16 GN 1/1 Food Pans	1
Angled Drying and Storage Cradle for 610 mm deep shelf only (Fits all Camshelving® lines)			
CSDR8	23 ⁵ / ₁₆ " x 10 ³ / ₈ " x 6 ⁵ / ₁₆ "	—	1
CSDR84	23 ⁵ / ₁₆ " x 10 ³ / ₈ " x 6 ⁵ / ₁₆ "	—	4

Drying Rack Color: Speckled Gray (480). **Drying Cradle Color:** Soft Gray (151).
*Rack height includes 5" casters.

Unit ships in



Premium Series Multi-Purpose Drying and Storage Racks

- For sheet pans, trays, cutting boards, food pans, storage containers, pots and pans and/or lids.
- Racks include vertical and angled drying cradles and may include 1 vented shelf plus shelf rails.

Holding Capacity Per Drying/Storage Tier

SHELF LENGTH	TRAYS	GN FULL SIZE FOOD PANS	PELLETS/BASES
36"	21	3	24
48"	28	4	32

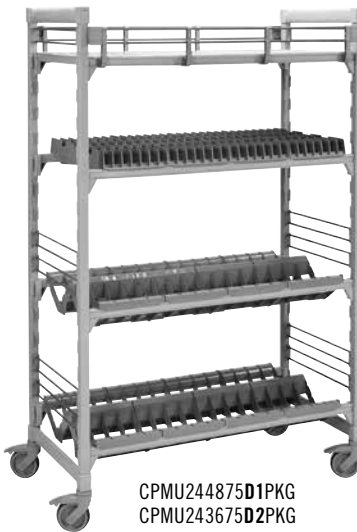

CPMU244875D1PKG
CPMU243675D2PKG



CPMU244875D3PKG
CPMU243675D4PKG

D1 and D2 Drying Racks Include 2 shelves of angled cradles, 1 shelf of vertical cradles, 1 vented shelf, 8 end rail kits and 1 full shelf rail kit.

D3 and D4 Drying Racks Include 2 shelves of angled cradles and 2 shelves of vertical cradles.

CODE	DIMENSIONS D x L x H*	CASE PACK
CPMU244875D1PKG	24" x 48" x 75"	1
CPMU243675D2PKG	24" x 36" x 75"	1
CPMU244875D3PKG	24" x 48" x 75"	1
CPMU243675D4PKG	24" x 36" x 75"	1

Drying Rack Color: Speckled Gray (480). **Drying Cradle Shelf Rail Color:** Soft Gray (151).
*Height includes 5" casters.

D1 and D2 units ship in



D3 unit ships in



D4 unit ships in



PREMIUM® SERIES DRYING AND STORAGE RACKS

Premium Series Dome Drying and Storage Rack

- For patient meal delivery domes.
- Cradle slot is 7,78 cm wide.



CSDDC24

CODE	DIMENSIONS D x L x H*	HOLDING CAPACITY	CASE PACK
Premium Series Dome Drying and Storage Rack			
CPMU243675DDPKG	24" x 36" x 75"	100 Domes	1
Dome Drying and Storage Cradle for 24" deep shelf only (Fits all Camshelving® lines)			
CSDDC24	24" x 16½" x 3⅜"	—	1
CSDDC245	24" x 16½" x 3⅜"	—	5

Drying Rack Color: Speckled Gray (480). **Drying Cradle Color:** Soft Gray (151).
*Rack height includes 5" casters.



Unit ships in



Premium Series Plate Cover Drying and Storage Rack

- For standard plate covers.
- Maximum plate cover dimensions
3" outside height, 10.8" inside diameter.

Fits Camwear Camcovers:

900CWNH, 1000CWNH, 1007CWNH,
1013CWNH.

Fits Versa Camcovers:

85SFVSNH 978SFVSNH, 86VSNH,
91VSNH, 913VSNH, 95VSNH, 99VSNH,
911VSNH, 100VSNH, 103VSNH,
105VSNH, 106VSNH, 110VSNH,
112VSNH.

CODE	DIMENSIONS D x L x H*	HOLDING CAPACITY
CPMU243675D5PKG	24" x 36" x 75"	80 Covers

Shelving Color: Speckled Gray (480). **Drying Cradle Color:** Soft Gray (151).
*Rack height includes 5" casters.



Unit ships in



Drying Rack/Cradle Reference Guide (for creating custom shelves or units)

Unit Length	Maximum Number of Drying Cradles per Tier			Unused Space per Tier with maximum number of cradles installed			Number of Products per Tier			
	TRAVERSE LENGTH	DOMES CSDDC24	ANGLED CSDR8	VERTICAL CSDR7	DOMES CSDDC24	ANGLED CSDR8	VERTICAL CSDR7	DOMES	BASES	TRAYS
24"		1	1	2	4.375"	10.25"	0"	10	8	14
30"		1	2	2	10.375"	6.25"	6.25"	10	16	14
36"		2	3	3	0"	2.62"	2.62"	20	24	21
42"		2	3	3	6"	8"	8"	20	24	21
48"		2	4	4	12"	3.75"	3.75"	20	32	28
54"*		3	4	4	1.75"	9.75"	9.75"	30	32	28
60"*		3	5	5	7.75"	5.5"	5.5"	30	40	35
72"*		4	6	6	3.375"	7.25"	7.25"	40	48	42

*Recommended for stationary units only

SECURITY CAGES

- Choose from single shelf or full wrap. Use in coolers, freezers and/or dry storage. Made of heavy duty, 304 stainless steel. Ships knockdown, lock not included.
- Install Full-Wrap Cage on Premium Series 24" x 48" x 64" stationary unit or 24" x 48" x 67" mobile unit. Requires bottom vented shelf for installation. Maximum lock shackle diameter is 5/16" mm.
- Single Shelf Security Cage fits all Camshelving lines. Install on 24" deep vented shelves only. Requires 18" or 4 open dovetails of space between shelves. Maximum lock shackle diameter is between 1/4" and 5/16".

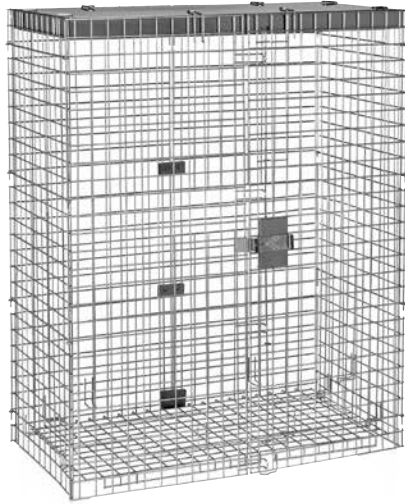

Full-Wrap Security Cage

CODE	DIMENSION D x L x H
Premium Series	
CPFWSC244860	26¾" x 50¼" x 61½"
Case Pack: 1 Color: Silver (000).	



Single Shelf Security Cage

CODE	DIMENSION D x L x H
Premium, Elements XTRA & Basics Plus Series	
CSSC244818	25¼" x 42½" x 18"
Case Pack: 1 Color: Silver (000).	

PREMIUM® SERIES FULL WRAP SECURITY CAGE UNITS

- Use in cooler, freezer or dry storage.
- Made of heavy duty, 304 stainless steel.
- Includes 2 vented shelves. Additional shelf kits can be ordered separately. Requires bottom vented shelf for installation.
- ID Tags and Divider Panels can be installed on shelves.
- Maximum lock shackle diameter is 5/16".
- Ships knockdown. Lock not included.

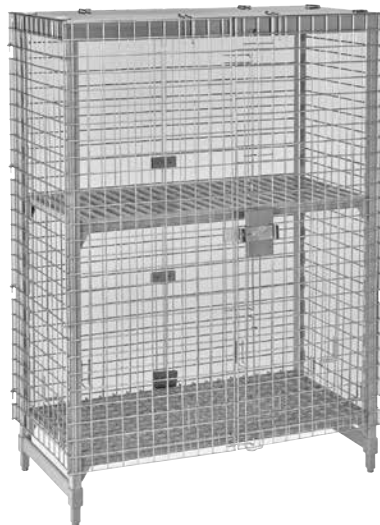

CODE	DESCRIPTION	DIMENSION D x L x H	COLOR
CPU244864SUPKG	Full-wrap Stationary Security Unit	26¾" x 50¼" x 64½"	Speckled Gray (480)
CPMU244867SUPKG	Full-wrap Mobile Security Unit	26¾" x 50¼" x 67¼"*	Speckled Gray (480)

*Height includes 5" casters.

Units ship in  2



ACE
Tomato Co., Inc.
Monterey, CA 95036
209 982-5691

ALTAR
PREMIUM QUALITY
ASPARAGUS

LOS MANAJOS

ALTA DENA
PREMIUM QUALITY

KEVIN'S
Fast Prep
Italian Dressing

La Mexicana
Salsa

La Mexicana
Salsa

KEVIN'S
Cocktail Sauce

KEVIN'S
Orange Sections

KEVIN'S
Garden of Eatin'
Mustard Dressing

KEVIN'S
Fast Prep
Italian Dressing

KEVIN'S
Fast Prep
Italian Dressing

KEVIN'S
Fast Prep
Italian Dressing

Tropical Cuts

HONEYDEW
MELONS

Marty Boy
RED PEPPERS

ONIONS
RIVER PO
FARMS
50 LBS.
NET WT. 22.7 kg

BOHN

ULTIMATE #10 CAN RACK SYSTEM

- Front loading, gravity fed storage system.
- Optimizes safe handling and FIFO food rotation.
- Made from 100% highly durable, plastic.
- Lifetime warranty against rust and corrosion.
- Modular pieces snap together easily and quickly without tools.
- Low maintenance versus metal – no dents, bent or sharp edges.
- Ships knockdown. Units include 1 or 2 factory assembled post kits.
- Easy to clean. Dishwasher safe.

#10 Single and Add-on Can Racks are covered by U.S. Patent D828,145 S and D827,421 S.



Storage Capacity

	Per Row	Per Full Unit
#10 can	8 each	96 each
#5 can	12 each	144 each

Full Size Can Rack Unit

- High volume can storage in a compact footprint.
- Install on end(s) of High-Density Floor Track System.



Full Size Starter Unit

Full Size Add-on Can Rack Unit

- Maximize every inch of linear space in your kitchen or dry storage area with an in-line can rack.
- Connect Add-on Units to other units with shared posts.



Starter and Add-On Unit

PREMIUM® SERIES

CODE	CPU243672C96	CPA243672C96*
DESCRIPTION	Full Size Starter Unit	Full Size Add-on Unit (shared posts)
DIMENSION D x L x H	26" x 36" x 72"	26" x 34 1/4" x 72"

ELEMENTS® XTRA SERIES

CODE	EXU243672C96	EXA243672C96*
DESCRIPTION	Full Size Starter Unit	Full Size Add-on Unit (shared posts)
DIMENSION D x L x H	26" x 36" x 72"	26" x 34" x 72"

Premium and Elements XTRA Series Color: Speckled Gray (480). *Cannot be installed as corner units.

Units ship in

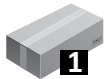

ULTIMATE #10 CAN RACK SYSTEM

Single and Add-on Can Rack Kits

- Create single shelves of can storage on existing or new shelving units.
- Requires additional traverse per shelf length to complete installation.

NOTE: Cannot install on shelves on corner units or on intermediate shelves (shelves installed between 2 units using corner connectors).

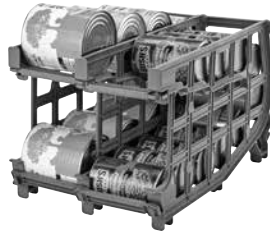

Partial Can Rack Storage

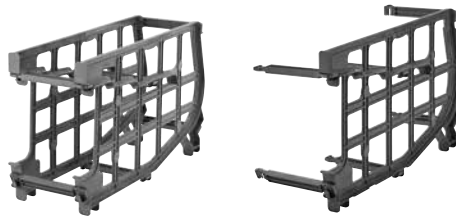

CODE	UCR10R8	UCR10AR8
DESCRIPTION	Single Can Rack, 2 panels and 6 brackets	Add-on Can Rack, 1 panel and 6 brackets
DIMENSION D x L x H	26" x 9¼" x 15½"	26" x 7¼" x 15½"
Case Pack: 1	Color: Brushed Graphite (580).	

Can Racks Per Shelf Length

SHELF LENGTH	NUMBER OF CAN RACKS PER TIER*	LEFTOVER SHELF SPACE	#10 CAN HOLDING CAPACITY
24"	2	3.5"	16
30"	3	2"	24
36"	4	0"	32
42"	4	6.5"	32
48"	5	5"	40
54"	6	3.5"	48
60"	7	2"	56

*1 Single Rack plus Add-on Racks.

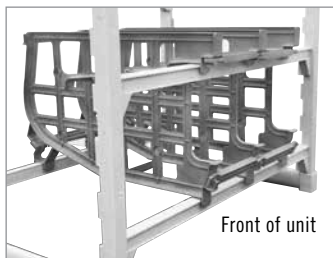

Front of unit

NOTE: Each tier of can racks requires 3 traverses, 2 front and 1 rear. Leave two open dovetails above top traverse before installing the next traverse/tier. This allows space to load cans. Can rack units cannot be specified to create corner units and individual racks cannot be installed on corner units.



PREMIUM® SERIES FLEX STATIONS

- Ideal for take-out, delivery, curbside pick-up or classroom feeding.
- Use for bulk food/produce staging, kitchen utensil storage or for paper goods.
- Units ship knockdown complete in 1 box with factory assembled post kits.
- Modular components assemble quickly. Easy to reconfigure as needs change.
- Smooth, plastic surfaces wipe clean. All parts dishwasher safe.
- Anti-microbial shelf plates provide added safety insurance.
- Each unit includes 12 ID tags. Identify contents quickly and minimize handling.
- Premium swivel plastic casters all with total locking brake – locks swivel and wheel.

Flex Stations shown with Optional Merchandiser, Food Storage Pans and/or Boxes, Cam GoBoxes® and Cambro GoBags®. Available for purchase separately.



CPM244867FX1



CPM244867FX2



CPM244867FX3



CPM244875FX4



Stack and separate items stored on shelves with 8" high Shelf Divider Panels.



CPM244875FX5

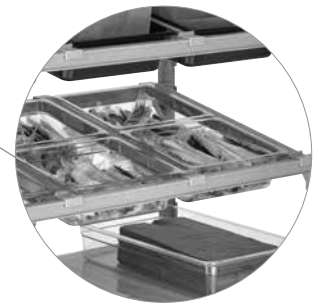

Create a custom station with a variety of food pans or food boxes and Shelf Divider Bars.

CODE	DESCRIPTION	DIMENSION D x L x H*
CPM244867FX1	4 Tiers with 36 Angled Divider Bars	24" x 48" x 67"
CPM244867FX2	1 Solid Shelf, 3 Tiers with 30 Angled Divider Bars	24" x 48" x 67"
CPM244867FX3	4 Solid Shelves with 16 Divider Panels	24" x 48" x 67"
CPM244875FX4	4 Solid Shelves with 16 Divider Panels	24" x 48" x 75"
CPM244875FX5	2 Solid Shelves, 3 Tiers with 30 Angled Divider Bars	24" x 48" x 75"

Color: Speckled Gray (480). *Height includes 5" casters.

Units ship in



PREMIUM® SERIES FLEX STATIONS

Flex Station Merchandiser Kits

- Made of heavy duty, all weather, durable plastic.
- Contemporary, colorful graphics for enhanced visibility and sales appeal.
- Fresh and Fast Kit includes magnetic menu holder on 1 side panel.
- Fits 67" or 75" tall mobile units.



CSFLEXMERCH
Ideal for promoting educational nutrition programs.

CSFLEXMERCH2
Excellent for customer recognition of pickup & go delivery sites.



CODE	DESCRIPTION	DIMENSIONS W x H
CSFLEXMERCH	Fast & Fresh Full Kit – 2 side panels, 1 top panel	23" x 56" side 48" x 6½" header
CSFLEXMERCH2	Pickup & Go Full Kit – 2 side panels, 1 top panel	23" x 56" side 48" x 6½" header
CSFLEXMERCH3	Fast & Fresh Top Panel Kit	48" x 6½"
CSFLEXMERCH4	Pickup & Go Top Panel Kit	48" x 6½"

Color: Multi (000).

Note: To ensure clearance through doors, please note overall flex station unit height is either 73½" or 81½" with merchandiser header installed.

Units ship in  **1**

Elements® XTRA Series 2-Shelf Vented Undercounter Units

- Create storage in underutilized or hard-to-reach undercounter areas.
- Ideal for storing paper goods and non-perishable condiments.
- Ships knockdown in 1 box with factory assembled post kits.



CODE	DIMENSIONS D x L x H
Stationary Units	
EXU183630V2	18" x 36" x 30"
EXU184830V2	18" x 48" x 30"
Color: Speckled Gray (480).	
Mobile Units	
EXMU142427V2	14" x 24" x 27¼"
EXMU143627V2	14" x 36" x 27¼"
EXMU144827V2	14" x 48" x 27¼"
Color: Speckled Gray (480). *Height includes casters.	



WALL SHELVES AND SHELF EXTENDERS

Wall Shelves

- Features virtually indestructible I-beam supports that hold up to 68 kg per shelf.
- Durable polypropylene withstands temperatures up to 190°F., and will not rust or corrode.
- Snap fit rail design allows shelves to snap on and off for easy cleaning.
- Backsplash and marine front edge controls spills and cross contamination.

CODE	EXTERIOR DIM. L x W x H
Solid Shelf	
CSWS1436SK	36" x 14" x 13½"
CSWS1448SK	48" x 14" x 13½"
CSWS1836SK	36" x 18" x 13½"
CSWS1848SK	48" x 18" x 13½"
Vented Shelf	
CSWS1436VK	36" x 14" x 13½"
CSWS1448VK	48" x 14" x 13½"
Shelf Extender	
CSWS36EK	35½" x 2" x 15½"
CSWS48EK	47½" x 2" x 15½"

Case Pack: 1 Wall Shelf Color: Speckled Gray (480).
Extender Peg Strip Color: Black (110).



Shelf Extenders ship in one carton with all hardware and includes:

LENGTH	PEG STRIPS	BRACKETS	HOOKS
36"	3	2	6
48"	3	3	9

Shelf Extenders

- Use with or without Camshelving Wall Shelves.
- Peg strips withstand temperatures up to 190°F, and will not rust or corrode.

S-SERIES DUNNAGE RACKS

- Keep frozen, cold or dry inventory 12" safely off the floor.
- One piece construction and sturdy legs provide strength and stability. Heavy duty polypropylene is safe to -36°F, and will not rust, corrode or bend.
- Choose slotted tops for maximum air circulation around perishable products stored in coolers or freezers.
- Solid tops catch spills for easy clean up.
- One Camlink included with each Dunnage Rack.



CODE	EXTERIOR DIMENSIONS H x D x W	LOAD CAPACITY
Solid Top		
DRS30	12" x 21" x 30"	1,500 lbs.
DRS36	12" x 21" x 36"	1,500 lbs.
DRS48	12" x 21" x 48"	3,000 lbs.
DRS60	12" x 21" x 60"	3,000 lbs.
Slotted Top		
DRS300	12" x 21" x 30"	1,500 lbs.
DRS360	12" x 21" x 36"	1,500 lbs.
DRS480	12" x 21" x 48"	3,000 lbs.
DRS600	12" x 21" x 60"	3,000 lbs.
Camlink		
DRLNK	—	—

Dunnage Rack Case Pack: 1
Color: Speckled Gray (480), Dark Brown (131).
Camlink Case Pack: 6 Color: Black (110).

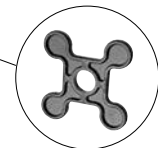
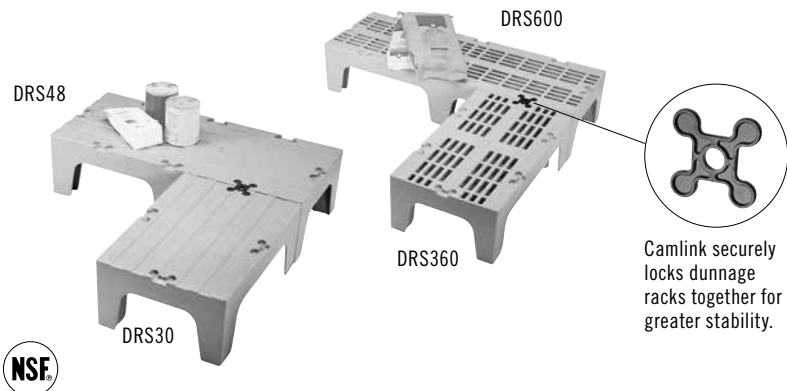

Camlink securely locks dunnage racks together for greater stability.

REPLACEMENT PARTS

Stationary Posts

CODE	HEIGHT
Premium® Series	
CSP32	32"
CSP56	56"
CSP64	64"
CSP72	72"
CSP84	84"
Elements® Series	
EP30	30"
EP64	64"
EP72	72"
EP84	84"
Elements® XTRA Series	
EXP30	30"
EXP64	64"
EXP72	72"
EXP84	84"
Basics® Plus Series	
CBP64	64"
CBP72	72"
CBP84	84"

Single Traverses

SINGLE PACK CODE	LENGTH	
Premium Series		
CPTR24	24"	
CPTR30	30"	
CPTR36	36"	
CPTR42	42"	
CPTR48	48"	
CPTR54	54"	
CPTR60	60"	
CPTR72	72"	
Elements Series Stationary / Elements XTRA Series Universal		
ETR24	ETR24	24"
ETR30	ETR30	30"
ETR36	ETR36	36"
ETR42	ETR42	42"
ETR48	ETR48	48"
ETR54	ETR54	54"
ETR60	ETR60	60"
ETR72	ETR72	72"
Elements Series Mobile		
EMTR36	36"	
EMTR42	42"	
EMTR48	48"	
EMTR54	54"	
EMTR60	60"	
Basics Plus Series		
CBTR30	30"	
CBTR36	36"	
CBTR42	42"	
CBTR48	48"	
CBTR54	54"	
CBTR60	60"	

Mobile Posts

CODE	HEIGHT
Premium Series	
CSPR67	67"
CSPR75	75"
Elements Series	
EMP27	27"
EMP70	70"
EMP78	78"
Elements® XTRA Series	
EXMP27	27"
EXMP70	70"
EXMP78	78"

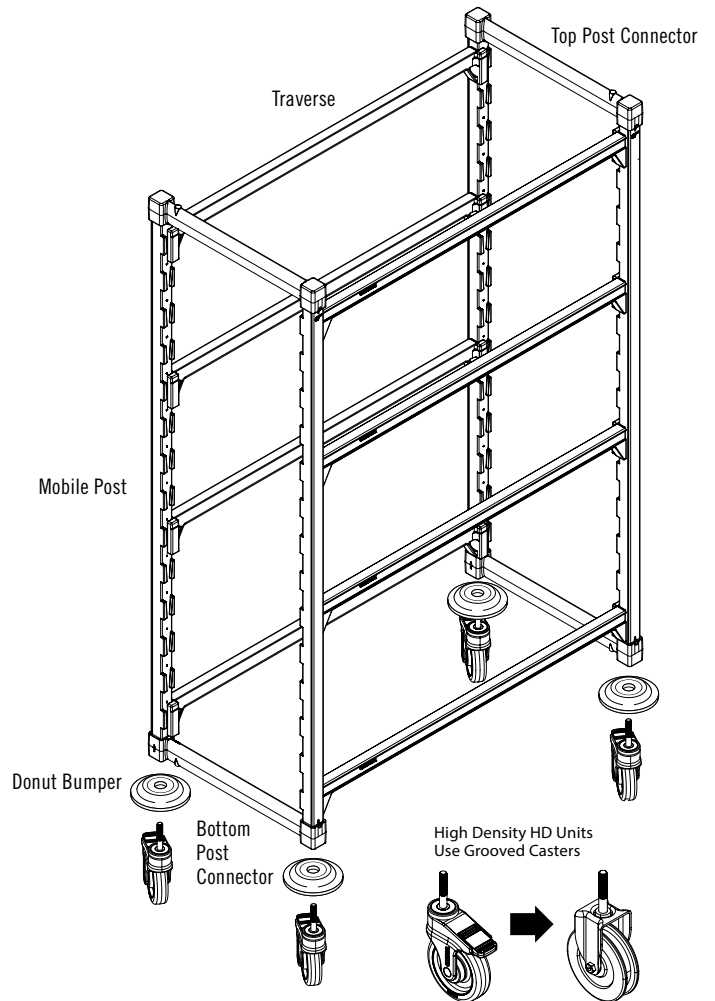

Post Connectors

CODE	DESCRIPTION	
Premium Series		
CSPCT14	Top Post Connector 14"	
CSPCB14	Bottom Post Connector 14"	
CSPCT18	Top Post Connector 18"	
CSPCB18	Bottom Post Connector 18"	
CSPCT21	Top Post Connector 21"	
CSPCB21	Bottom Post Connector 21"	
CSPCT24	Top Post Connector 24"	
CSPCB24	Bottom Post Connector 24"	
Elements/Elements XTRA Series		
EPCT14	EXPCT14	Top Post Connector 14"
EPCB14	EXPCB14	Bottom Post Connector 14"
EPCT18	EXPCT18	Top Post Connector 18"
EPCB18	EXPCB18	Bottom Post Connector 18"
EPCT21	EXPCT21	Top Post Connector 21"
EPCB21	EXPCB21	Bottom Post Connector 21"
EPCT24	EXPCT24	Top Post Connector 24"
EPCB24	EXPCB24	Bottom Post Connector 24"
Basics Plus Series		
CBPCT18	Top Post Connector 18"	
CBPCB18	Bottom Post Connector 18"	
CBPCT21	Top Post Connector 21"	
CBPCB21	Bottom Post Connector 21"	
CBPCT24	Top Post Connector 24"	
CBPCB24	Bottom Post Connector 24"	

REPLACEMENT PARTS

Post Connector Collar Wedges

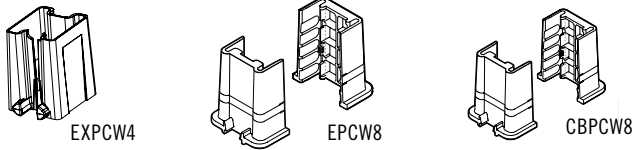

CODE	DESCRIPTION
Elements® Series	
EPCW8	Bag of 8 Collar Wedges (4A and 4B)
Elements® XTRA Series	
EXPCW4	Bag of 4 Collar Wedges)
Basics® Plus Series	
CBPCW8	Bag of 8 Collar Wedges (4A and 4B)

Corner Connectors

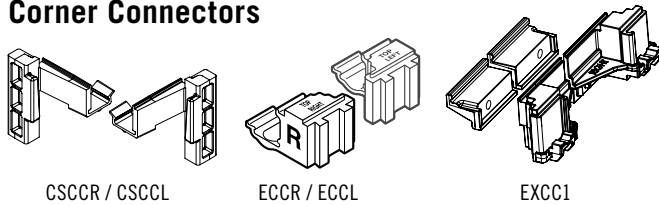

CODE	DESCRIPTION
Premium® Series	
CSCCR	Right Corner Connector
CSCCL	Left Corner Connector
Elements Series	
ECCR	Right Corner Connector
ECCL	Left Corner Connector
Elements XTRA Series	
EXCC1	Right Corner Connector
(includes hardware)	Left Corner Connector
Basics Plus Series	
CBCCR	Right Corner Connector
CBCCL	Left Corner Connector

Casters and Donut Bumpers

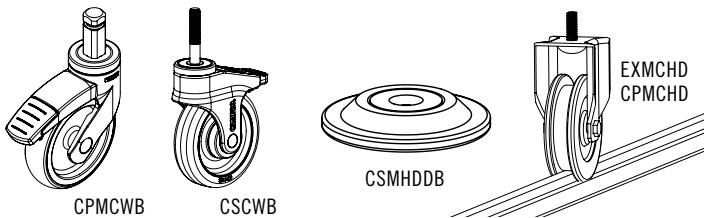

CODE	DESCRIPTION
Premium Series	
CPMCWB	5" caster with total locking brake
CPMDB	Donut Bumper for CPMCWB
High Density	
CPMCHD	5" grooved caster, no brake, includes bumper for Premium Series
EXMCHD	5" grooved caster, no brake, includes bumper for Elements XTRA Series
CSMHDB	Donut Bumper only
Elements, Elements XTRA Series	
CSCWB	5" caster with total locking brake and square toe pedal
CSMHDB	Donut Bumper for CSCWB

Traverse Dovetails

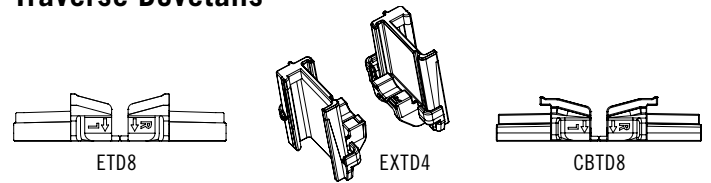

CODE	DESCRIPTION
Elements Series — Stationary	
ETD8	Bag of 8 Dovetails, 4 each snap-apart, L and R
Elements Series — Mobile	
EMTD8	Bag of 8 Dovetails, 4 each, A and B
Elements XTRA Series — Universal	
EXT4	Bag of 4 Dovetails, 2 left and 2 right
Basics Plus Series — Stationary Only	
CBTD8	Bag of 8 Dovetails, 4 each snap-apart, L and R

Post Leveling Foot

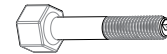

CODE	DESCRIPTION
CSLF	Premium, Elements, Elements XTRA and Basics Plus Series

High Density Rails and Hardware

Track Joiner Kit H09010 includes:



Track End Plate Kit H09011 includes:

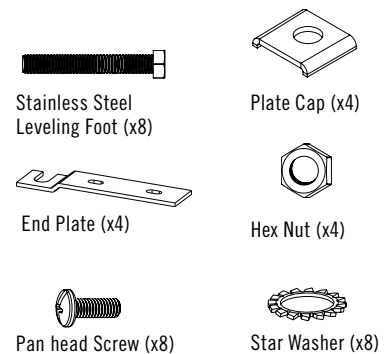

CODE	DESCRIPTION
S09006	4.5' Rail Set
S09007	5' Rail Set
S09008	6' Rail Set
H09010	Track Rail Joiner Kit
H09011	Track End Plate Kit

REPLACEMENT PARTS

Wall Shelving

CODE	DESCRIPTION
CSWS1836S	36" Wall Shelf Solid, 18" Width
CSWS1436S	36" Wall Shelf Solid, 14" Width
CSWS1436V	36" Wall Shelf Vented, 14" Width
CSWS1448S	48" Wall Shelf Solid, 14" Width
CSWS1448V	48" Wall Shelf Vented, 14" Width
CSWB14	14" Wall Shelf Bracket Kit
CSWB	18" Wall Shelf Bracket Kit
S06001	Peg Strip, 36" Long
S06002	Peg Strip, 48" Long
S06003	3-Peg Hooks
S06004	3-Peg Strip Screws
H06003	2-Lag Screws, 2-Washers
CSSE	Extender

Ultimate Sheet Pan Rack

CODE	DESCRIPTION
Post Connector Frames and Wedges	
S19001	Bottom Post Connector Frame
S19002	Top Post Connector Frame
S19003	Wedges, Bag of 16
Rail Panel	
S19005	Rail Panel with 3" Spacing
S19006	Rail Panel with 1 1/2" Spacing
Caster/Post Insert	
EMCWB	5" Caster with total locking brake/round toe pedal (for units sold before May 2021)
CSCWB	5" Caster with total locking brake/square toe pedal (for units sold after May 2021)
S19007	Caster Zinc 5" with Brake
S19008	Caster Zinc 5" No Brake
S19009	Caster Zinc 3" with Brake for Undercounter Units only
S19010	Caster Zinc 3" No Brake for Undercounter Units only
S19004	Post Insert 4 Sets

Full Wrap Security Cage

CODE	DESCRIPTION
S13010	Clamp Plates, Stainless Steel
S13011	Bolt Plate w/ Nuts, Stainless Steel
S13012	Bottom Plates, Stainless Steel
S13013	Hinge Bushing (16 each)
S13014	Nut, Stainless Steel 10-32

Padlock shackle maximum diameter is 5/16".

Single Shelf Security Cage

CODE	DESCRIPTION
S07005	Security Hook

Padlock shackle maximum diameter is 1/4".

Ultimate #10 Can Rack

CODE	DESCRIPTION
UCRCANRB6	Brackets, Bag of 6



SHELF PLATES AND DRYING RACK SHELF CONFIGURATIONS

Shelf Plates for Camshelving Premium®, Elements® and Elements XTRA Series

SHELF PLATE DIMENSIONS	SOLID SHELF PLATE CODE	VENTED SHELF PLATE CODE	PLATE POSITIONING
14" Deep			
14" x 6"	CS146S	CS146V	A
14" x 11"	CS1411S	CS1411V	B
14" x 12"	CS1412S	CS1412V	C
14" x 18"	CS1418S	CS1418V	D
18" Deep			
18" x 6"	CS186S	CS186V	A
18" x 11"	CS1811S	CS1811V	B
18" x 12"	CS1812S	CS1812V	C
18" x 18"	CS1818S	CS1818V	D
21" Deep			
21" x 6"	CS216S	CS216V	A
21" x 11"	CS2111S	CS2111V	B
21" x 12"	CS2112S	CS2112V	C
21" x 18"	CS2118S	CS2118V	D
24" Deep			
24" x 6"	CS246S	CS246V	A
24" x 11"	CS2411S	CS2411V	B
24" x 12"	CS2412S	CS2412V	C
24" x 18"	CS2418S	CS2418V	D

Color: Speckled Gray (480).

Shelf Plates for Camshelving Basics® Plus Series

SHELF PLATE DIMENSIONS	SOLID SHELF PLATE CODE	VENTED SHELF PLATE CODE	PLATE POSITIONING
18" Deep			
18" x 6"	CBSP186S	CBSP186V	A
18" x 11"	CBSP1811S	CBSP1811V	B
18" x 12"	CBSP1812S	CBSP1812V	C
21" Deep			
21" x 6"	CBSP216S	CBSP216V	A
21" x 11"	CBSP2111S	CBSP2111V	B
21" x 12"	CBSP2112S	CBSP2112V	C
24" Deep			
24" x 6"	CBSP246S	CBSP246V	A
24" x 11"	CBSP2411S	CBSP2411V	B
24" x 12"	CBSP2412S	CBSP2412V	C

TRAVERSE LENGTH	PLATE CONFIGURATION FOR 14", 18", 21", 24" DEEP PREMIUM, ELEMENTS & ELEMENTS XTRA SHELVING				
24"	B	B			
30"	B	A	B		
36"	B	C	B		
42"	B	D	B		
48"	B	C	C	B	
54"	B	C	D	B	
60"	B	D	D	B	
72"	B	C	D	D	B

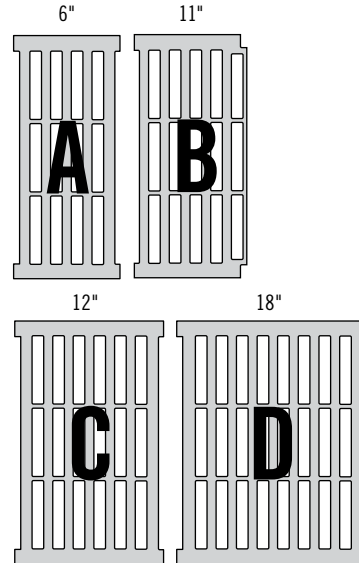

(18" available for Premium and Elements XTRA Series only.)

TRAVERSE LENGTH	PLATE CONFIGURATION FOR 18", 21", 24" DEEP BASICS PLUS SHELVING				
30"	B	A	B		
36"	B	C	B		
42"	B	A	C	B	
48"	B	C	C	B	
54"	B	A	C	C	B
60"	B	C	C	C	B



Telephone: (714) 848-1555 Toll Free: (800) 854-7631 Customer Service: (800) 833-3003
© Cambro Manufacturing Company 5801 Skylab Road, Huntington Beach, CA 92647
LIT2350 Printed in U.S.A. 09/23