

2023 Catalog



Chef[®] R E V I V A L

— CHEF APPAREL, APRONS AND TOWELS —

www.JohnRitz.com



BUTTON STYLE



White Chef Logo



Black Chef Logo

Classic Short Sleeve Jackets



Thermometer and pen pocket on sleeve

- EZ-Blend™ material
- Double-breasted jacket with traditional collar
- Drop shoulder and yoke for comfort
- 8 chef logo buttons
- Sleeve thermometer and pen pocket
- Short sleeves keep you cool and comfortable
- Double stitched for durability

ITEM	DESCRIPTION	MATERIAL	COLOR	BUTTON	SIZE
J005	Short Sleeve Jacket	EZ-Blend™	White	White Chef	XS-5X
J005BK	Short Sleeve Jacket	EZ-Blend™	Black	Black Chef	XS-5X



Classic Long Sleeve Jackets



EZ-Blend™ is a versatile cotton-poly blend combining comfort, durability, and ease-of-cleaning.

- EZ-Blend™ material
- Double-breasted with traditional collar
- Drop shoulder and yoke
- 8 buttons
- Sleeve thermometer and pen pocket
- Double stitched for durability

BUTTON STYLE



White Chef Logo

ITEM	DESCRIPTION	MATERIAL	COLOR	BUTTON	SIZE
J002	Long Sleeve Jacket	EZ-Blend™	White	Chef Logo	XS-8X





Fresh Jackets



BUTTON STYLE



Black Chef Logo

Black trim for collar and cuffs

- EZ-Blend™ material
- Double-breasted with traditional collar
- Black collar and cuffs
- 8 black Chef logo buttons
- 3/4 length sleeves
- Sleeve thermometer and pen pocket

ITEM	DESCRIPTION	MATERIAL	COLOR	BUTTON	SIZE
J134TM	¾ Sleeve Jacket	EZ-Blend™	Tomato	Black Chef	XS-5X



Performance Jackets



Breathable Mesh Back



Side vents for a better fit



BUTTON STYLE



White Chef Logo



Black Chef Logo

ITEM	DESCRIPTION	MATERIAL	COLOR	BUTTON	SIZE
J200BK	Long Sleeve Jacket	EZ-Blend™	Black	Black Chef	XS-3X
J205	Short Sleeve Jacket	EZ-Blend™	White	White Chef	XS-3X
J205BK	Short Sleeve Jacket	EZ-Blend™	Black	Black Chef	XS-3X
J205GR	Short Sleeve Jacket	EZ-Blend™	Grey/Black	Black Chef	XS-3X

- EZ-Blend™ material
- Double-breasted with traditional collar
- Double stitched for durability
- Breathable mesh on back
- 8 Chef logo buttons
- Sleeve thermometer and pen pocket
- Side vents to keep you cool



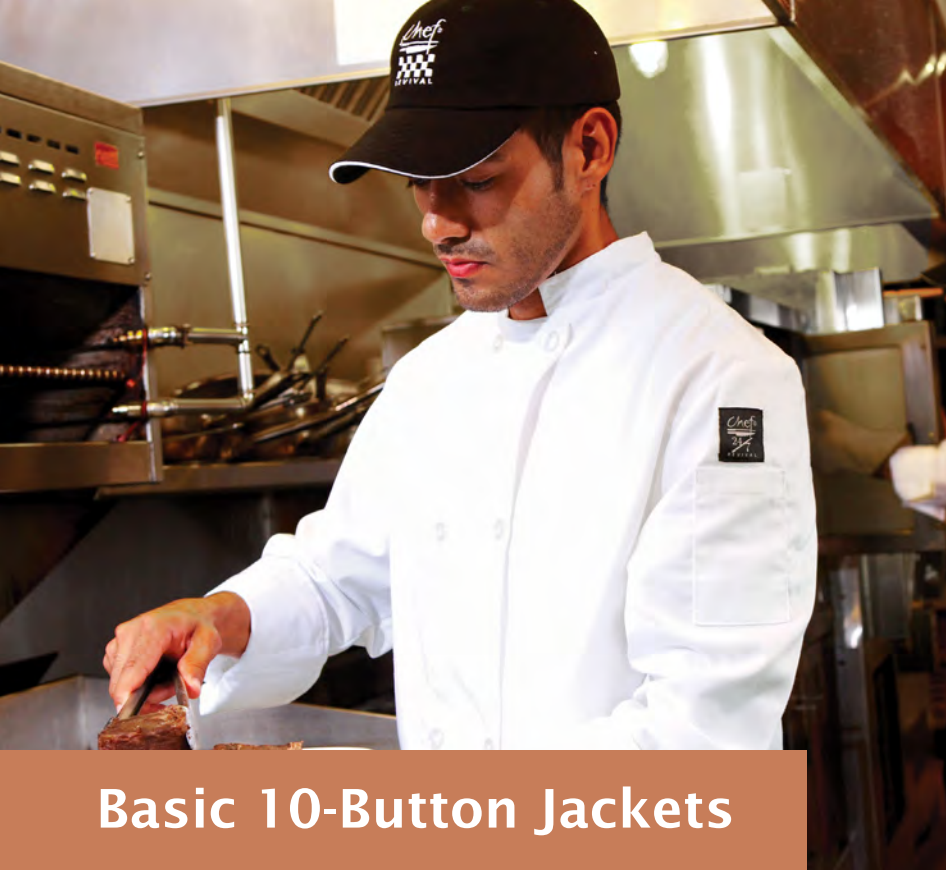

Basic 10-Button Jackets

The basic jackets are the true work horse in chef apparel when it comes to durability, comfort and overall value. The standard cotton-poly blend fabric features a traditional collar, double breasted design, thermometer/pen pocket and the addition of a front chest pocket for frequently-used tools.

- EZ-Blend™ material
- Double-breasted with traditional collar
- 10 pearl buttons
- Sleeve thermometer and pen pocket
- Chest pocket



Thermometer and pen pocket on sleeve



Short sleeves available in both black and white jackets



Chest pocket

BUTTON STYLE



Clear Pearl



Black Pearl

ITEM	DESCRIPTION	MATERIAL	COLOR	BUTTON	SIZE
J105	Short Sleeve Jacket	EZ-Blend™	White	Clear Pearl	XS-3X
J109BK	Short Sleeve Jacket	EZ-Blend™	Black	Black Pearl	XS-3X
J100	Long Sleeve Jacket	EZ-Blend™	White	Clear Pearl	XS-3X



Basic Long-Sleeve Jackets

EZ-Blend™ is a versatile cotton-poly blend combining comfort, durability, and ease-of-cleaning.

- EZ-Blend™ material
- Double-breasted with traditional collar
- 8 buttons
- Sleeve thermometer and pen pocket

BUTTON STYLE



Clear Pearl

Cloth Knot

Black Chef Logo



Thermometer and pen pocket on sleeve



Chest pocket

ITEM	DESCRIPTION	MATERIAL	COLOR	BUTTON	SIZE
J049	Long Sleeve Jacket	EZ-Blend™	White	Clear Pearl	XS-5X
J050	Long Sleeve Jacket	EZ-Blend™	White	Cloth Knot	XS-5X
J061BK	Long Sleeve Jacket	EZ-Blend™	Black	Black Chef Logo	XS-5X
J071BK	Long Sleeve Jacket w/ Chest Pocket	EZ-Blend™	Black	Black Chef Logo	XS-5X





Cook Shirts



- Lightweight comfortable cotton-poly blend material
- Short sleeve only
- 6 snap buttons
- Chest pocket

ITEM	DESCRIPTION	MATERIAL	COLOR	BUTTON	SIZE
CS006WH	Short Sleeve Shirt	EZ-Blend™	White	Snap	XS-4X
CS006BK	Short Sleeve Shirt	EZ-Blend™	Black	Snap	XS-4X

Cargo Pants

Mens Cargo Pants

- EZ-Blend™ material
- 6 pockets for car keys, cell phones and more: 2 side, 2 rear and 2 snap side leg pockets
- Zip fly closure
- Elastic waistband w/drawstring



ITEM	DESCRIPTION	MATERIAL	COLOR	SIZE
P024BK	Cargo Pants	EZ-Blend™	Black	XS-5X

EZ-Blend™ is a versatile cotton-poly blend combining comfort, durability, and ease-of-cleaning.



Ladies Cargo Pants

- EZ-Blend™ material
- 6 pockets for car keys, cell phones and more: 2 side, 2 rear and 2 snap side leg pockets
- Tailored front panel
- Elastic waistband in back
- Comfortably fits curves

ITEM	DESCRIPTION	MATERIAL	COLOR	SIZE
LP002BK	Cargo Pants	EZ-Blend™	Black	XXS-3X





Baggy Pants

Back pockets

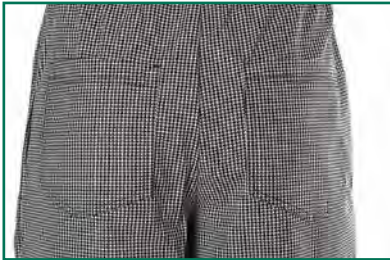

Side pockets



- EZ-Blend™ material
- Comfy fit
- 2" elastic waistband with drawstring
- 2 side pocket and 2 rear pockets for convenience



ITEM	DESCRIPTION	MATERIAL	COLOR	SIZE
P020BK	Baggy Pants	EZ-Blend™	Black	XS-8X
P020HT	Baggy Pants	Yarn-Dyed EZ-Blend™	Houndstooth	XS-8X



E-Z™ Fit Pants



- EZ-Blend™ material
- Relaxed fit
- 2" elastic waistband with drawstring
- Zip fly closure
- 2 side pockets and 2 rear pockets

ITEM	DESCRIPTION	MATERIAL	COLOR	SIZE
P002BK	EZ™ Fit Pants	EZ-Blend™	Black	XS-5X
P004HT	EZ™ Fit Pants	Yarn-Dyed EZ-Blend™	Houndstooth	XS-5X





Tools You Can Trust

Why settle for anything less? Chef Revival® aprons offer only the highest quality fabrics to ensure comfort, consistent color and are made to last. Corners are bar-tack stitched to resist tearing and pocket droop. Chef Revival® aprons are designed to work as hard as you do.



Quality Fabrics



Quality Design

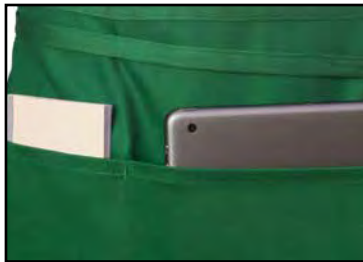

Quality Stitching



ALL APRONS ARE MACHINE WASHABLE AND CAN BE LAUNDERED IN A COMMERCIAL WASHING MACHINE



Shown: VNA3840-BK

Tuxedo Apron

ITEM	POCKETS	MATERIAL	COLOR
VNA3840-BK	2 Front Pockets	EZ-Blend™	Black

- EZ-Blend™ cotton-poly material
- 2 front pockets
- V-neck
- Adjustable neck strap
- 38" ties on each side
- 28" w x 32" h (71 x 81 cm)
- One size fits most



Shown:
619BA-WS

Pinstripe Bib Apron

ITEM	POCKETS	MATERIAL	COLOR
619BA-WS	2 Front Pockets	EZ-Blend™	Black/White Pinstripe

- EZ-Blend™ cotton-poly material
- 2 front pockets
- Adjustable neck strap
- 43" ties on each side
- 29" w x 38" h (74 x 97 cm)
- One size fits most



No Pocket Bib Aprons

ITEM	POCKETS	MATERIAL	COLOR
601NP-*	No Pockets	EZ-Blend™	8 Options

*Specify color suffix when ordering



- EZ-Blend™ cotton-poly material
- No pockets
- 50" ties on each side
- 28" w x 34" h (71 x 86 cm)
- One size fits most



Shown: 601NP-WH

ITEM	POCKETS	MATERIAL	COLOR
600PS-NP-BK	No Pockets	Polyester	Black
600PS-NP	No Pockets	Polyester	White

- Spun polyester
- Fade, wrinkle and stain resistant
- No pockets
- 40" long ties on each side
- 27" w x 32" h (69 x 81 cm)
- One size fits most



Shown: 600PS-NP



Shown: 601BAC-RB



Shown: 411BA-WH

1 Pocket Bib Aprons

ITEM	POCKETS	MATERIAL	COLOR
601BAC-*	1 Side Pocket	EZ-Blend™	8 Options

*Specify color suffix when ordering



- EZ-Blend™ cotton-poly material
- Side pocket can hold a tablet
- 45" long ties on each side
- 28" w x 34" h (71 x 86 cm)
- One size fits most



ITEM	POCKETS	MATERIAL	COLOR
411BA-WH	1 Pen Pocket	EZ-Blend™	White
412BA-BK	1 Pen Pocket	EZ-Blend™	Black

- EZ-Blend™ cotton-poly material
- Pen pocket
- 1" wide adjustable neck strap
- Bar-tack stitched
- 45" long ties on each side
- 29" w x 34" h (74 x 86 cm)
- One size fits most



3 Pocket Bib Aprons

ITEM	POCKETS	MATERIAL	COLOR
601BAO-3*	3 Front Pockets	EZ-Blend™	7 Options

*Specify color suffix when ordering



- EZ-Blend™ cotton-poly material
- Adjustable neck strap
- 3 front pockets
- One pocket can hold a tablet
- 50" long ties on each side
- 28"w x 30"h (71 x 76 cm)
- One size fits most



Shown: 601BAO-3-RD

ITEM	POCKETS	MATERIAL	COLOR
602BAFH-*	3 Front Pockets	EZ-Blend™	8 Options

*Specify color suffix when ordering



- EZ-Blend™ cotton-poly material
- 3 front pockets
- One pocket can hold a tablet
- 45" long ties on each side
- 28"w x 25"h (71 x 64 cm)
- One size fits most



Shown: 602BAFH-NV

Economy Bib Aprons

A basic bib apron that's comfortable and portrays a polished and professional image.

- Cotton-poly or cotton material
- Durable and comfortable
- 40" long ties on each side
- One size fits most
- Available in white



600BAW-XL



Shown: 600BAW

ITEM	DESCRIPTION	POCKETS	MATERIAL	SIZE
600BAW	Bib Apron	1 Pen	55/45 Cotton-poly	34"w x 34"h (86 x 86 cm)
600BAW-NP	Bib Apron	No Pocket	55/45 Cotton-poly	34"w x 34"h (86 x 86 cm)
600BAW-D	Deluxe Fabric Bib Apron	1 Pen	65/35 Cotton-poly	34"w x 34"h (86 x 86 cm)
600BAW-XL	Extra Wide Bib Apron	1 Pen	55/45 Cotton-poly	38"w x 30"h (97 x 76 cm)
610BAC	Bib Apron	1 Pen	100% Cotton	36"w x 40"h (91 x 102 cm)

Utility Bib Apron

ITEM	POCKETS	MATERIAL	COLOR
601-MAJ	No Pockets	Polyester with Vinyl Backing	Black

Provides excellent protection in an institutional or commercial foodservice environment.

- Polyester with vinyl backing
- Waterproof and fire retardant
- No pockets
- Adjustable neck strap
- 28" long ties on each side
- 27"w x 33"h (69 x 84 cm)
- One size fits most



Shown: 601-MAJ



Shown: 612BAFH-WH



Shown: 602PS-BK

3 Pocket Bib Aprons

ITEM	POCKETS	MATERIAL	COLOR
612BAFH-*	3 Front Pockets	EZ-Blend™	8 Options

*Specify color suffix when ordering



- EZ-Blend™ cotton-poly material
- Adjustable neck strap
- 3 front pockets
- One pocket can hold a tablet
- 45" long ties on each side
- 28" w x 27" h (71 x 69 cm)
- One size fits most



ITEM	POCKETS	MATERIAL	COLOR
602PS-BK	3 Front Pockets	Polyester	Black

- Spun polyester
- Fade, wrinkle and stain resistant
- 3 front pockets
- One pocket can hold a tablet
- 40" long ties on each side
- 27" w x 24" h (69 x 61 cm)
- One size fits most





4-Way Bistro Apron

ITEM	POCKETS	MATERIAL	COLOR
A005	No Pockets	EZ-Blend™	White

- EZ-Blend™ cotton-poly material
- Stay clean by flipping or turning the apron around
- No pockets
- 45" ties on each side
- 28" w x 30" h (71 x 76 cm)
- One size fits most



Flips 4 ways to ensure chefs and servers have a clean apron throughout their entire shift.

Shown: A005

Chef Revival®



Hip Pocket Bistro Aprons

ITEM	POCKETS	MATERIAL	COLOR
607BA	1 Pocket	EZ-Blend™	White
607BA-BK	1 Pocket	EZ-Blend™	Black

- EZ-Blend™ cotton-poly material
- Right side patch pocket
- 50" ties on each side
- 33"w x 30"h (84 x 76 cm)
- One size fits most



Shown: 607BA

ITEM	POCKETS	MATERIAL	COLOR
A011BK	1 Pocket	EZ-Blend™	Black

- EZ-Blend™ cotton-poly material
- Right side patch pocket
- 45" tangle-free ties on each side
- 28"w x 33"h (71 x 84 cm)
- One size fits most



Shown: A011BK

Tangle-free ties

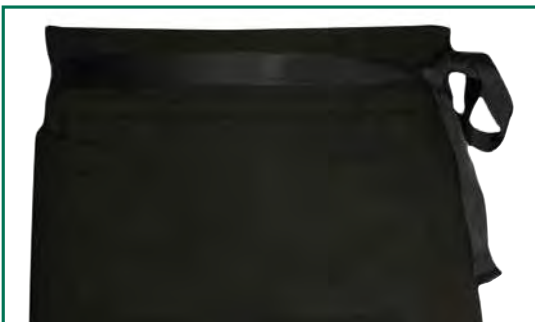



Shown: 607BA2-BK

2 Pocket Bistro Aprons

Keep your staff looking professional and safe from spills with these long, durable, bistro aprons. Convenient pockets to hold frequently used tools: guest check presenter, tablet, pens and more.

ITEM	POCKETS	MATERIAL	COLOR
607BA2-WH	2 Pockets	EZ-Blend™	White
607BA2-BK	2 Pockets	EZ-Blend™	Black

- EZ-Blend™ cotton-poly material
- 2 middle pockets that can hold a tablet
- 50" ties on each side
- 28" w x 34" h (71 x 86 cm)
- One size fits most



Shown: 607HBA2-WH

Half Bistro Aprons

ITEM	POCKETS	MATERIAL	COLOR
607HBA2-WH	2 Pockets	EZ-Blend™	White
607HBA2-BK	2 Pockets	EZ-Blend™	Black

- EZ-Blend™ cotton-poly material
- Offers generous storage space
- 2 center pockets can hold a tablet
- 45" ties on each side
- 28" w x 19" h (71 x 48 cm)
- One size fits most



4-Way Waist Aprons

ITEM	POCKETS	MATERIAL	COLOR
603FWPS-BK	No Pockets	Polyester	Black

- Spun polyester
- Fade, wrinkle and stain resistant
- Stay clean by flipping or turning the apron around
- No pockets
- 41" long ties on each side
- 28"w x 17"h (71 x 43 cm)
- One size fits most



ITEM	POCKETS	MATERIAL	COLOR
603FW	No Pockets	EZ-Blend™	White

- EZ-Blend™ cotton-poly material
- Stay clean by flipping or turning the apron around
- No pockets
- 45" long ties on each side
- 34"w x 17"h (86 x 43 cm)
- One size fits most



Flips 4 ways to ensure chefs and servers have a clean apron throughout their entire shift



Shown: 603FWPS-BK

Reversible Waist Apron

ITEM	POCKETS	MATERIAL	COLOR
605REV-BK	3 Pockets	EZ-Blend™	Black

- EZ-Blend™ cotton-poly material
- Reversible: flip to a clean side
- 3 pockets per side
- One pocket can hold a tablet
- 50" long ties on each side
- 24w x 12"h (61 x 30 cm)
- One size fits most



Shown: 605REV-BK



Shown: 605WAFH-WH



Shown: 605PS-BK

3 Pocket Waist Aprons

ITEM	POCKETS	MATERIAL	COLOR
605WAFH-*	3 Pockets	EZ-Blend™	8 Options

*Specify color suffix when ordering



- EZ-Blend™ cotton-poly material
- 3 front pockets
- One pocket can hold a tablet
- 45" long ties on each side
- 24" w x 12" h (61 x 30 cm)
- One size fits most



ITEM	POCKETS	MATERIAL	COLOR
605PS-BK	3 Pockets	Polyester	Black

- Spun polyester
- Fade, wrinkle and stain resistant
- 3 front pockets
- One pocket can hold a tablet
- 41" long ties on each side
- 24w x 12"h (61 x 30 cm)
- One size fits most





Chef Headwear



Professional Chef Hats

- Cotton-poly blend
- Adjustable velcro tab
- Lightweight
- One size fits most



Chef Berets

- Cotton-poly blend
- Adjustable back strap
- Air holes on sides to keep you cool
- One size fits most

ITEM	DESCRIPTION	MATERIAL	COLOR
H400WH	13" (33 cm) Tall	Cotton-poly	White
H400BK	13" (33 cm) Tall	Cotton-poly	Black

ITEM	DESCRIPTION	MATERIAL	COLOR
H036WH	Chef Beret	Cotton-poly	White
H036BK	Chef Beret	Cotton-poly	Black



Disposable Chef Hats

- Non-woven fiber
- Adhesive closure
- Pinstripe pattern
- Sold by the case pack (50 hats per case)
- One size fits most



Disposable Corporate Chef Hats

- Non-woven fiber
- Adjustable velcro tab
- Pinstripe pattern
- Sold by the case pack (25 hats per case)
- One size fits most

ITEM	DESCRIPTION	MATERIAL	COLOR
H048	7" (18 cm) Tall	Non-woven Fiber	White
H049	8½" (22 cm) Tall	Non-woven Fiber	White

ITEM	DESCRIPTION	MATERIAL	COLOR
H055	7" (18 cm) Tall	Non-woven Fiber	White
H056	9" (23 cm) Tall	Non-woven Fiber	White



Crew Headwear



Chef Beanie

- 100% cotton
- Elastic band on back
- Embroidered Chef logo
- One size fits most

ITEM	DESCRIPTION	MATERIAL	COLOR
H060BK	Chef Beanie	100% Cotton	Black



Scarf Hat

- Cotton-poly blend
- Adjustable
- Machine washable
- One size fits most

ITEM	DESCRIPTION	MATERIAL	COLOR
H020BK	Scarf Hat	Cotton-poly	Black



Mesh Top Pill Box Hats

- Cotton-poly blend
- Breathable mesh top
- Elastic band in the back
- Machine washable
- Sizes: Regular (20"-22") or Extra-Large (22"-23.5")

ITEM	DESCRIPTION	MATERIAL	COLOR
H002*	Pill Box Hat	Cotton-poly	White
H008*	Pill Box Hat	Cotton-poly	Black



Disposable Bouffant Cap

- Soft, non-irritating polypropylene
- Elastic fit
- Latex-free and anti-static
- Sold by the case pack (1000 per case)
- One size fits most

ITEM	DESCRIPTION	MATERIAL	COLOR
BCAP110CW	24" Bouffant Cap	Polypropylene	White

*Specify size suffix (R or XL) when ordering





Baseball Caps



Baseball Caps

- 100% cotton
- Adjustable strap
- Embroidered Chef logo
- One size fits most



Custom Baseball Caps

- Embroidered* with your logo (File must be EPS, TIFF, PDF, or JPEG)
- 1 logo or 2 lines of text
- 2 week lead-time
- Also available without embroidery

ITEM	DESCRIPTION	MATERIAL	COLOR
H063WH	Baseball Cap	100% Cotton	White
H064BK	Baseball Cap	100% Cotton	Black

ITEM	DESCRIPTION	MATERIAL	COLOR
H067BK	Embroidered Cap	100% Cotton	Black

*See page 31 for additional embroidery information



Bar Towels



Ribbed Bar Mop Towels

- 100% cotton material
- Absorbent
- Narrow-ribbed construction
- Machine washable

ITEM	SIZE	MATERIAL	COLOR
700BRT24	24 oz, 16" x 19"	100% Cotton	White
700BRT28	28 oz, 16" x 19"	100% Cotton	White
700BRT32	32 oz, 16" x 19"	100% Cotton	White



Full Terry Bar Mop Towels

- 100% cotton terry material
- Absorbent
- Narrow-ribbed construction
- Machine washable
- 30 oz

ITEM	SIZE	MATERIAL	COLOR
701BTT30	16" x 19"	100% Cotton Terry	White



Waffle-Weave Bar Towels

- 100% cotton material
- Waffle-weave design provides extra scrubbing ability
- Machine washable

ITEM	SIZE	MATERIAL	COLOR
700WT	18" x 18"	100% Cotton	Natural



Striped Bar Towels

- 100% cotton material
- Colored stripe allows for color-coding for specific uses
- Machine washable
- 32 oz

ITEM	SIZE	MATERIAL	COLOR
700BRT-BLS	16" x 19"	100% Cotton	Blue Stripe
700BRT-GLS	16" x 19"	100% Cotton	Gold Stripe
700BRT-GRS	16" x 19"	100% Cotton	Green Stripe
700BRT-RDS	16" x 19"	100% Cotton	Red Stripe



Bar & Kitchen Towels



Heavyweight Bar Mop Towels

- 100% high-grade cotton terry material
- Absorbent
- Machine washable

ITEM	SIZE	MATERIAL	COLOR
HTI250W	40 oz, 15" x 25"	100% Cotton Terry	White
HTI275W	44 oz, 16" x 27"	100% Cotton Terry	White



Multi Stripe Towels

- 100% cotton terry material
- Absorbent
- High quality construction
- Striped for easy identification
- Machine washable

ITEM	SIZE	MATERIAL	COLOR
705MSK	15" x 26"	100% Cotton Terry	Multi Stripe



Herringbone Towels

- 100% cotton material
- Low lint and highly absorbent
- Color stripe for easy identification
- Machine washable

ITEM	SIZE	MATERIAL	COLOR
703HB	15" x 26"	100% Cotton	Green Stripe
703HB28	20" x 28"	100% Cotton	Multi-Color Stripes



Oversized Chef Towels

- 100% cotton terry material
- Premium grade weight (44oz)
- Color stripe for easy identification
- Machine washable

ITEM	SIZE	MATERIAL	COLOR
HTI15GS	15" x 25"	100% Cotton	Green Stripe



Kitchen Towels & Dish Cloths



Glass Polishing Towels

- 100% cotton material
- Eliminates streaking on glasses
- Picks up and holds dust and dirt
- Hypoallergenic and lint-free
- Machine washable

ITEM	SIZE	MATERIAL	COLOR
702GT	16" x 29"	100% Cotton	Red Pinstripe



Flour Sack Towels

- 100% cotton material
- Lightweight, flour sack material
- Shaped for long pans
- Machine washable

ITEM	SIZE	MATERIAL	COLOR
704FSTW	22" x 37"	100% Cotton	White



Waffle-Weave Dish Cloths

- 100% cotton material
- Waffle-weave design provides extra scrubbing ability
- Machine washable

ITEM	SIZE	MATERIAL	COLOR
706DC	12" x 13"	100% Cotton	Green Check



50ct Microfiber Cloths Box

- Semi-disposable microfiber cleaning cloths
 - Designed to help foodservice professionals reduce cross-contamination in high-risk areas by ensuring cleaner and safer surfaces
- Machine washable up to 20x



ITEM	SIZE	MATERIAL	COLOR
97186	12" x 12"	Polyester/Polyamide	Blue



Size Information

Sizing Chart: Inch and Centimeter Measurements

Order size according to your chest or hip measurements, whichever is larger.

Disclaimer: This is intended to be a guide only, and while we do our best to ensure all our sizing is consistent, you may find that some styles vary in size.

Jackets:

Chest/Bust: Measure over clothing to be worn. Measure around fullest part of chest or bust, under the arms and around shoulder blades. Keep tape straight and level.

Pants:

Waist: Measure around natural waistline above hip bones. Don't hold your breath.

Hips: Measure around fullest part of hip.

Inseam Length: Measure from base of crotch seam to top of shoe to be worn.

Note: Styles & cuts could vary in size.

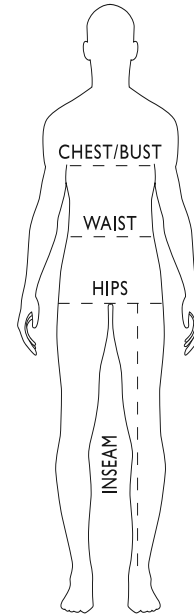

INCHES	XXS	XS	S	M	L	XL	2X	3X	4X	5X	6X*	7X*	8X*
MENS/UNISEX JACKETS													
Chest (inch)	-	32-34	36-38	40-42	44-46	48-50	52-54	56-58	60-62	64-66	68-70	72-74	76-78
MENS/UNISEX PANTS													
Waist (inch)	-	24-26	28-30	32-34	36-38	40-42	44-46	48-50	52-54	56-58	60-62	64-66	68-70
Hip (inch)	-	34-36	38-40	42-44	46-48	50-52	54-56	58-60	62-64	66-68	70-72	74-76	78-80
Inseam Length (inch)	-	30	32	33	34	34	34	34	34	34	34	34	34
LADIES PANTS													
Waist (inch)	18-19	20-21	22-23	24-25	26-27	28-30	32-34	36-38	40-42	-	-	-	-
Hip (inch)	38	40	42	44	46	48	50	52	54	-	-	-	-
Inseam Length (inch)	28	30	32	33	34	34	34	34	34	-	-	-	-

CENTIMETERS	XXS	XS	S	M	L	XL	2X	3X	4X	5X	6X	7X	8X
MENS/UNISEX JACKETS													
Chest (cm)	-	81-86	91-96	101-106	111-116	121-127	132-137	142-147	152-157	162-167	-	-	-
MENS/UNISEX PANTS													
Waist (cm)	-	61-66	71-76	81-86	91-96	101-106	111-116	121-127	131-137	142-147	152-157	162-167	172-177
Hip (cm)	-	86-91	96-101	106-111	116-121	127-132	137-142	147-152	157-162	167-172	177-182	187-193	198-203
Inseam Length (cm)	-	76	81	83	86	86	86	86	86	86	86	86	86
LADIES PANTS													
Waist (cm)	45-48	50-53	55-58	60-63	66-68	71-76	81-86	91-96	101-106	-	-	-	-
Hip (cm)	96	101	106	111	116	121	127	132	137	-	-	-	-
Inseam Length (cm)	71	76	81	83	86	86	86	86	86	-	-	-	-



Embroidery Information

Thread Colors:



Font Choices:



Embroidered chef apparel will add the finishing touch to your uniforms. Logos, names and flags can be embroidered on Chef Revival® coats, shirts, aprons and hats.

For more information and to upload your logo artwork scan the QR code below or visit: www.johnritz.com/foodservice/embroidery-services/



Scan with smartphone to get started on your custom embroidery

Placement Options:

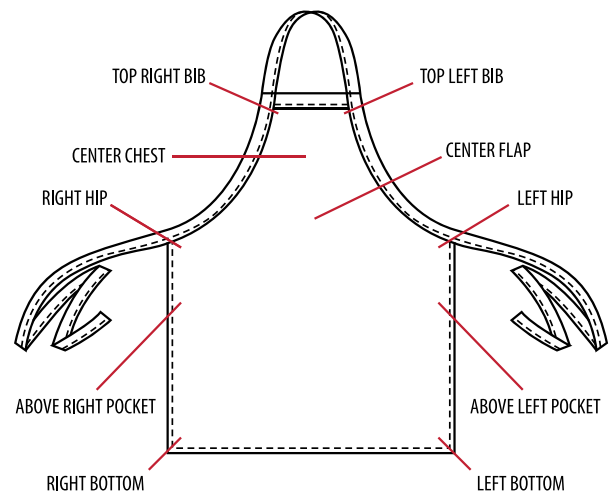
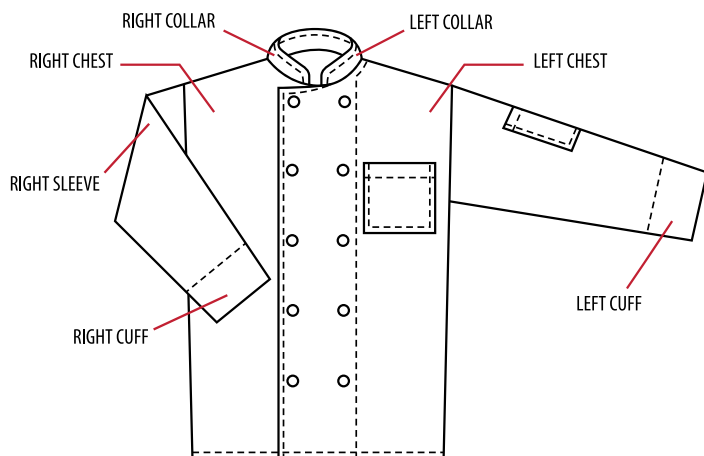



John Ritzenthaler Company
40 Portland Road
West Conshohocken, PA 19428
Tel: 610.834.7280

www.JohnRitz.com/chefrevival
RITZfoodservice@JohnRitz.com