

Risch®

Menus & More Since 1935

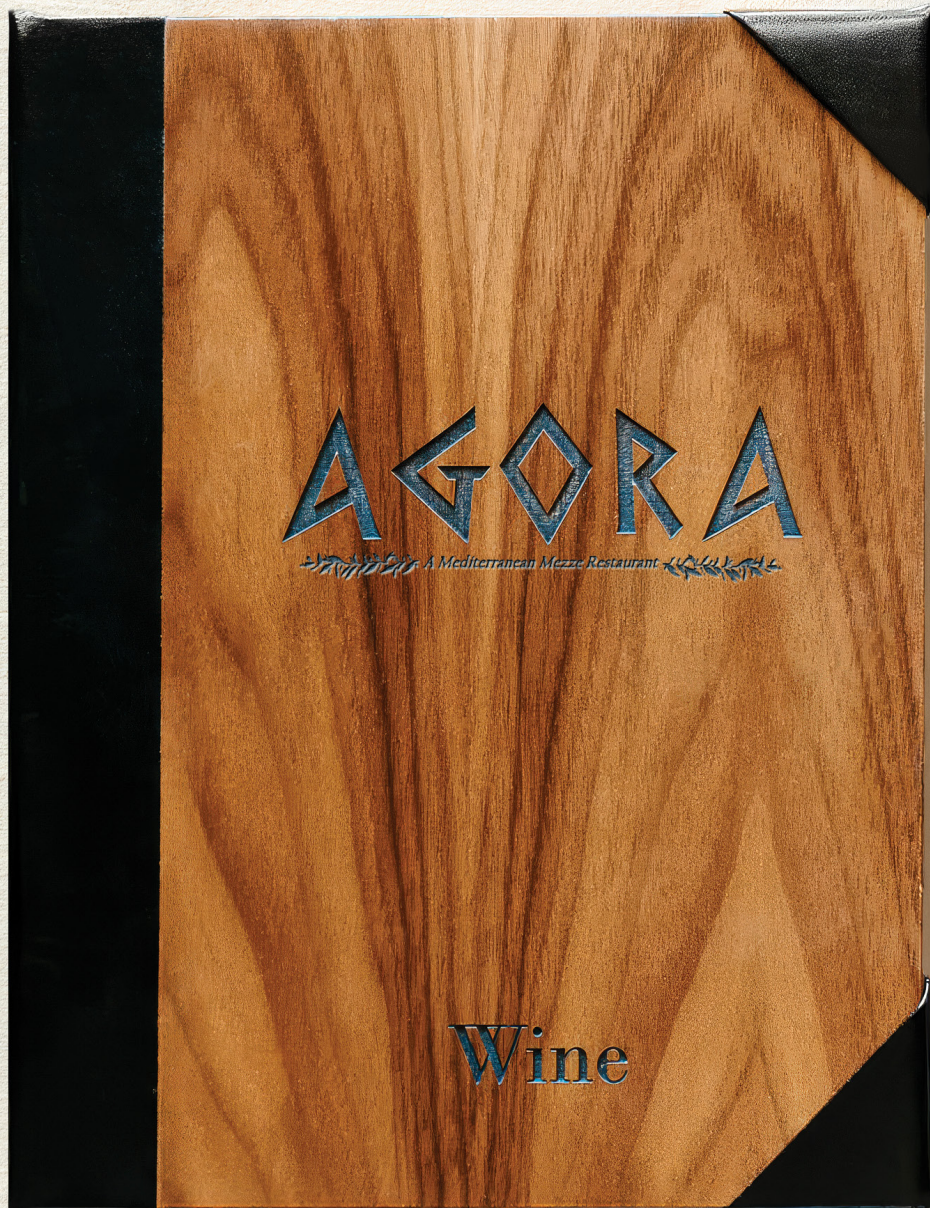

CATALOG

Premium Menu Covers Crafted For Hospitality

OUR STORY

Risch Inc. was founded in 1935 by Hans Risch, an immigrant from Liechtenstein, who sought a better life for his family in Upstate New York. He began his journey in the menu cover business, printing and selling paper menus door-to-door, leaving an impression wherever he went.

Fast forward nearly a century and you will find a women-owned, women-led, 3rd and 4th generation employed business that remains thriving and true to its vision: helping all customers, no matter the size of industry, make beautiful, lasting first impressions to grow their brands and businesses.

Risch remains one of the top USA manufacturers within the restaurant and hospitality industries. Our quality and vision have continually been strengthened by expanding and adjusting our product lines to meet the ever-changing needs of our customers and industries we represent.

OUR MISSION

We believe in helping customers set the table for success through our curated selection of artisan designed & handcrafted products.



WOMEN LED
SMALL BUSINESS



SPECIALIZE IN
CUSTOM

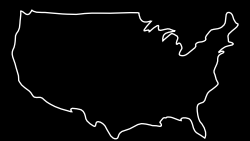

HANDMADE
IN THE USA 

CONFIGURATIONS GUIDE

- 05 Material Bound Configurations
- 09 Genuine Leather Configurations
- 10 Material-Configuration Chart

MATERIAL BOUND

LEATHER INSPIRED

- 13 Genuine Leather
- 14 Harley
- 15 Oakmont
- 16 Tuxedo Leather
- 17 Tamarac

WOVEN & TEXTURED

- 19 Chesterfield
- 20 Linen
- 21 Milan
- 22 Rattan
- 23 Rio
- 24 Vienna

NATURAL & ECO INSPIRED

- 26 Authentic Wood
- 27 Evergreen
- 28 Sherwood
- 29 Vino

METALLIC FINISH

- 31 Iridescent
- 32 Metro
- 33 Patina
- 34 Sterling

FORMAT SHOWCASE

- 36 Seville & Seville Deluxe
- 37 Gatsby Clipboard
- 38 Augusta Banded
 - Augusta Eyelet
 - Augusta Screwpost
- 39 Pinehurst 3-Ring Binder
 - Chicago Menu Board
- 41 LED Backlit Interior
 - Material Bound LED Backlit Interior
- 42 Sewn Pajco
 - Pajco Spiral
- 43 H2O
 - Waterproof Tear-Proof Paper

VINYL MENUS

- 45 All Clear Vinyl Menu Covers
- 46 Black Vinyl Menu Cover
 - Tuscan Menu Board
 - All Clear Spiral Menu Cover

DELUXE SEWN MENUS

- 48 Deluxe Sewn Menu Covers
- 50 Heat-Sealed Add-A-Page
 - Sewn Add-A-Page

WOOD MENUS & SIGNAGE

- 52 Wood Menu Board
 - Wood Clipboard
 - Butler Menu Board
- 53 Two-Sided Table Tent
 - Three-Sided Table Tent
 - Roll Stand Pack
 - Street Talker

CHECK PRESENTERS & PAD HOLDERS

STOCK CHECK PRESENTERS

- 55 Country Board
 - Double Panel LED
 - Padded Single Panel
 - Padded Double Panel
 - Hardback Single Panel
 - Genuine Leather Mini

MATERIAL BOUND CHECK PRESENTERS

- 56 Hardback Single Panel
 - Hardback Double Panel
 - Double Panel LED
 - Genuine Leather

WAITSTAFF PAD HOLDERS

- 57 Deluxe Waitstaff Pad Holder
 - Deluxe Waitstaff Pad Holder With Clip
 - Genuine Leather Server Pad Holder

PLACEMATS & COASTERS

- 59 Material Bound Placemats & Coasters
- 60 Vinyl Placemats & Coasters
- 61 GA Vinyl Woven Placemats

ACCESSORIES

- 62 Stiffeners (Chipboard & Tag Paper)
 - Page Protectors
 - Silicone Bands
- 63 Vinyl Sheet Protectors
 - Decorative Elastic Bands & Barbs

CUSTOMIZATION

- 65 Customization Options
- 66 Color Foil Stamp Options
- 67 Monticello Window
- 68 Deluxe Upgrades & Add-Ons
- 69 Customize Pockets
 - Page & Sheet Protectors
- 70 General Information

California Proposition 65 Notice

WARNING: Certain products in this catalog may require a California Proposition 65 warning. Products requiring a warning will be labeled accordingly. For current Prop 65 status on specific items, please contact customer service prior to placing an order.

 Indicates product may require a California Proposition 65 warning.

DESIGNING YOUR MENU COVER

Every Risch product is designed with flexibility in mind. Our configuration options allow you to tailor menu covers, check presenters, binders, and accessories to match the exact needs of your operation or brand.

By selecting the options that best fit your application, you can create a finished piece that reflects both function and style. Use this guide as a starting point when specifying your product. If you need assistance refining your selections or developing a custom solution, our team is ready to help bring your vision to life.

For decades, Risch has partnered with hospitality professionals to produce presentation products that enhance the guest experience and stand up to the demands of daily service.



MATERIAL BOUND CONFIGURATION GUIDE

CARD INTERIOR*

Code: **CARD**



This padded or hardback menu cover comes standard with a black card interior and black album style corners.

Sizes Available: 4.25" x 11", 4.25" x 14", 5.5" x 8.5", 8.5" x 11", 8.5" x 14", 11" x 17" (1 View Only), Custom

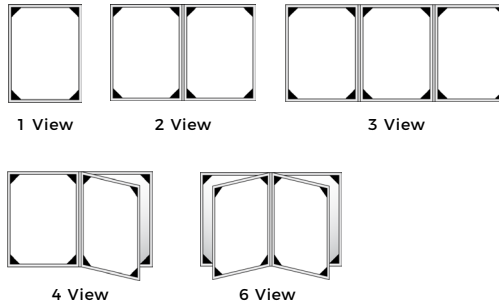

POCKET INTERIOR*

Code: **PKT**



This hardback menu cover comes standard with a pocket interior, black leatherette trim, and gold smooth corners.

Sizes Available: 4.25" x 11", 4.25" x 14", 5.5" x 8.5", 8.5" x 11", 8.5" x 14", Custom

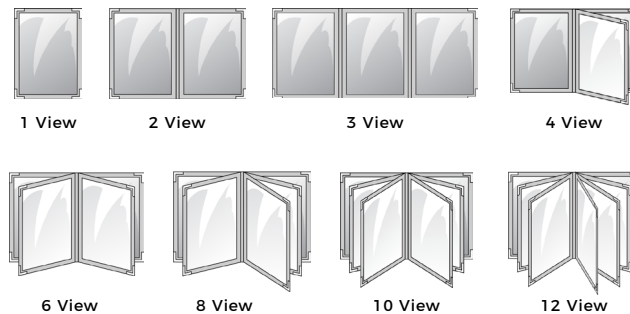

AUGUSTA BANDED*

Code: **AUGUSTA**



This padded or hardback menu cover comes standard with a black interior, and holds folded paper menu inserts with an elastic band around the spine.

Sizes Available: 4.25" x 11", 4.25" x 14", 5.5" x 8.5", 8.5" x 11", 8.5" x 14", Custom



* Padded or Hardback is dependent on material choice by configuration - see configuration section on material pages to confirm.



AUGUSTA SCREWPOST

Code: AUG3POST

This hardback menu cover features a black interior with a floating hinge that holds three-hole-punched paper inserts, secured with three 3/8" black screw posts concealed through the back.

Sizes Available: 4.25" x 11", 4.25" x 14", 5.5" x 8.5", 8.5" x 11", 8.5" x 14", Custom



AUGUSTA EYELET*

Code: EYELET

This hardback menu cover comes standard with a black interior, black eyelets, and holds folded paper menu inserts with a barbed elastic band.

Sizes Available: 4.25" x 11", 4.25" x 14", 5.5" x 8.5", 8.5" x 11", 8.5" x 14", Custom

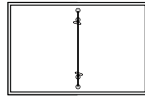

LED BACKLIT INTERIOR

Code: LED-2V

This hardback menu cover features a black interior with two LED backlit panels and a top-loading design for easy insertion of menu inserts. Includes LED panels and a USB charging cable.

Sizes Available: 8.5" x 11", 8.5" x 14"



LED BACKLIT CHECK PRESENTER

Code: LED-CHECK

This hardback check presenter features LED backlit panels that illuminate checks for improved visibility in low-light settings. Includes corner straps, a pen holder, and a USB charging cable.

Sizes Available: 5.5" x 10.75"

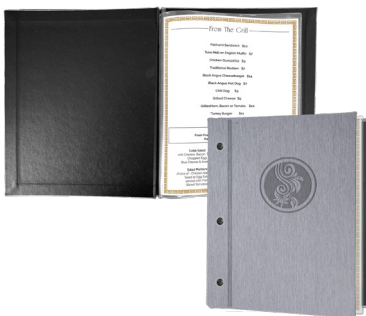
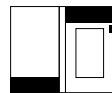

CHICAGO MENU BOARD

Code: CMBFF

This hardback menu cover features a black interior with 3/8" black screw posts mounted on the exterior spine to securely hold three-hole-punched menu inserts.

Sizes Available: 4.25" x 11", 4.25" x 14", 5.5" x 8.5", 8.5" x 11", 8.5" x 14", Custom



MAGNETIC MENU BOARD

Code: **MMB**

This hardback menu board comes with a black front liner panel and a 1 3/4" magnetic hinge matching the back material.

Sizes Available: 4.25" x 11", 4.25" x 14", 5.5" x 8.5", 8.5" x 11", 8.5" x 14", 11" x 17", Custom

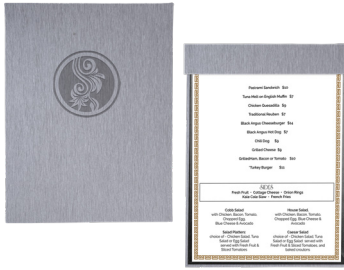

3-RING BINDER*

Code: **PINE3RING**

This padded or hardback binder comes standard with a black interior and a 1/2" silver three ring.

Sizes Available: 4.25" x 11", 4.25" x 14", 5.5" x 8.5", 8.5" x 11", 8.5" x 14", Custom

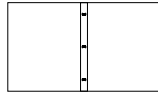

CRCC CHECK PRESENTER

Code: **5000H-CRCC**

This hardback check presenter comes with diagonal corners with a credit card holder on the top right panel.

Sizes Available: 5" x 9"

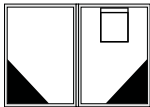

STRIP CHECK PRESENTER

Code: **5000H-ST**

This hardback check presenter comes with strips on the top right and bottom left panels.

Sizes Available: 5" x 9"



SINGLE PANEL CHECK PRESENTER

Code: **1000H**

This hardback check presenter comes with a 2" black strip pocket across the bottom.

Sizes Available: 5.25" x 9"



* Padded or Hardback is dependent on material choice by configuration - see configuration section on material pages to confirm.

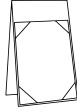

TABLE TENT

Code: TENT

This double-sided hardback table tent comes standard with black cards and black album style corners. Optional 2" header for logo imprinting.

Sizes Available: 4" x 6", 4" x 8", 5" x 7", 8.5" x 11", Custom



PLACEMAT

Code: PLACEMATDX

This flexible placemat comes with stitched edges, black non-skid backing, and is offered in both a rectangle and octagon configuration.

Sizes Available: 15" x 11", 15" x 13", 16" x 12", 17" x 11", 17" x 13", Custom

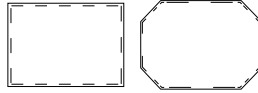

TABLEMAT

Code: TABLEMAT

This table mat comes with rigid hardboard, stitched edges, black non-skid backing, and is offered in both a rectangle and octagon configuration.

Sizes Available: 15" x 11", 15" x 13", 16" x 12", 17" x 11", 17" x 13", Custom

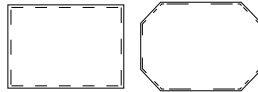

COASTER

Code: COASTER

This material bound coaster features rigid hardboard, stitched edges, and a black non-skid backing.

Size Available: 4" x 4"

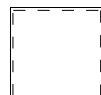

GENUINE LEATHER CONFIGURATIONS



PORTFOLIO

Code: GENUINE-PORTFOLIO

This flexible, unpadded portfolio comes with stitched edges and holds folded paper menu inserts with an elastic band around the spine (sold separately).

Sizes Available: 8.5" x 14", 8.5" x 11", 5.5" x 8.5", 4.25" x 14", 4.25" x 11", Custom



EYELET PORTFOLIO

Code: GENUINE-EYELET

This flexible, unpadded portfolio has silver, gold, and black barbs available (sold separately). Silver eyelet color is standard, gold and black available upon request.

Sizes Available: 8.5" x 14", 8.5" x 11", 5.5" x 8.5", 4.25" x 14", 4.25" x 11", Custom



BINDER

Code: GENUINE-BINDER

This flexible, unpadded binder comes with stitched edges and a 1/2" silver 3-ring mechanism.

Sizes Available: 8.5" x 14", 8.5" x 11", 5.5" x 8.5", 4.25" x 14", 4.25" x 11", Custom



CHECK PRESENTER

Code: GENUINE-CHECK or GENUINE-CHECK-MINI

This flexible, unpadded check presenter comes with stitched edges, and a right corner pocket with a vertical card holder slit.

Sizes Available: 5" x 8.5" (Standard), 4" x 7.5" (Mini)



SERVER PAD HOLDER

Code: GENUINE-SPH

This flexible, unpadded server pad holder comes with stitched edges, and a left and right pocket.

Sizes Available: 5.5" x 9.25"

Made from real cowhide leather with a finished exterior and natural hide interior. These covers are flexible and do not include rigid or padded board.

MATERIAL CONFIGURATIONS CHART

MATERIALS	CONFIGURATIONS				
	CARDED MENU	POCKET MENU	MAGNETIC MENU BOARD	TABLEMAT	PREMIUM SEWN PLACEMAT
	3 RING BINDER	AUGUSTA EYELET	TABLE TENT	COASTER	
	CHICAGO MENU BOARD 5000H	AUGUSTA BANDED AUGUSTA SCREWPOST	LED MENU LED CHECK PRESENTER 1000H		
CHESTERFIELD	✓	✓	✓	✓	✓
EVERGREEN	✓	✓	✓	✓	✓
HARLEY	✓	✓	✓	✓	✓
IRIDESCENT	✓	✓	✓	✓	✓
LINEN	✓	✓	✓		
METRO	✓	✓	✓		
MILAN	✓	✓	✓	✓	✓
OAKMONT	✓	✓	✓	✓	
PATINA	✓				
RATTAN	✓	✓	✓	✓	✓
RIO	✓	✓	✓	✓	✓
SHERWOOD	✓	✓	✓	✓	✓
STERLING	✓	✓	✓		
TAMARAC	✓	✓	✓	✓	✓
TUXEDO LEATHER	✓	✓	✓	✓	
VIENNA	✓	✓	✓	✓	✓
VINO	✓	✓	✓	✓	✓
WOOD	✓				

LEATHER INSPIRED & GENUINE LEATHER

Elevate your menu presentation with leather-inspired and genuine leather covers that offer a refined look and lasting durability. Available in a wide range of colors and textures, each style is designed for customization and a strong first impression.



Roma's
ITALIAN KITCHEN



Handwritten signature or brand name in cursive script.

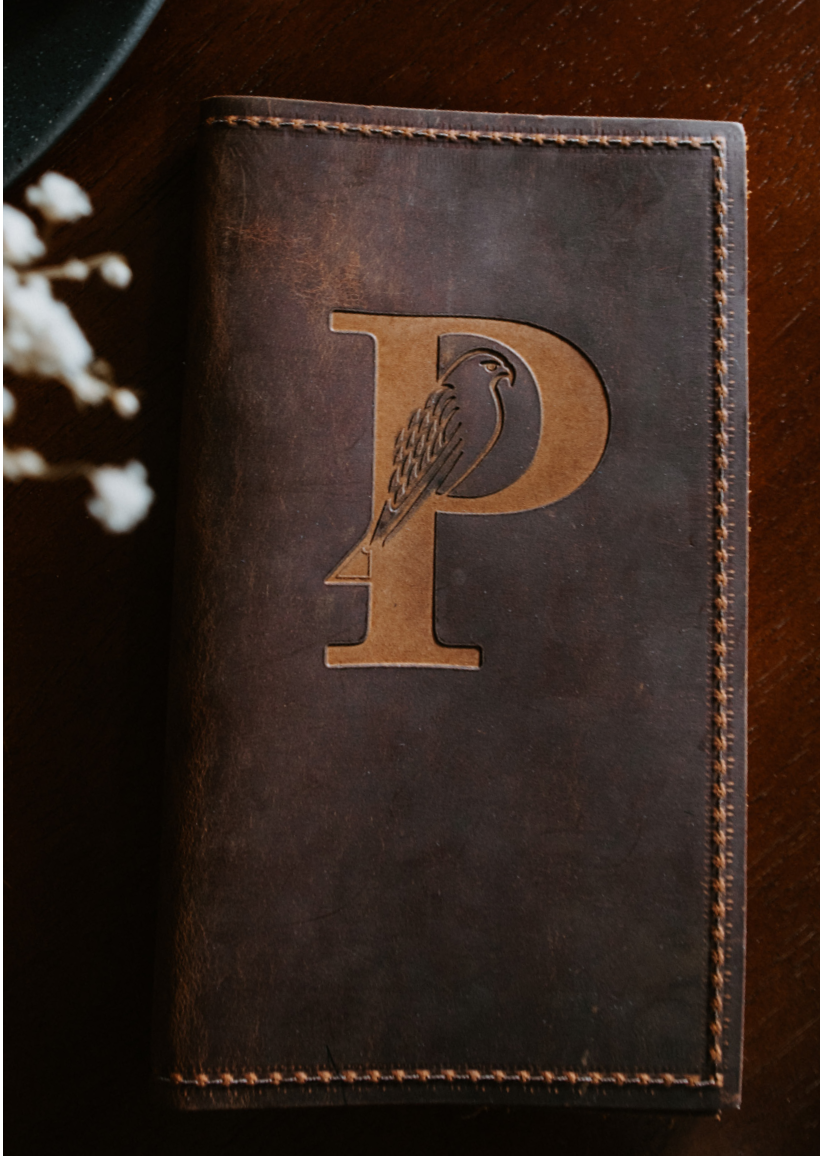

GENUINE LEATHER

A rustic elegance ideal for establishments looking to accentuate their timeless style, our Genuine Leather is soft, supple, and luxurious to the touch.

Known for its strength and durability, the flexible leather will naturally weather, crease and fold over time, which creates a unique and personalized look for each cover.

FREE Logo Customization Options:
see pg. 65 for more info



BURNISHING

COLOR SWATCHES



Black



Blue

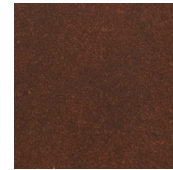

Brown

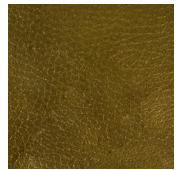

Gold*



Green

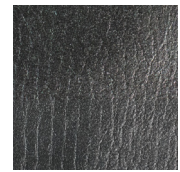

Silver*

**Available in Check Presenters Only*

CONFIGURATIONS

see pgs. 5-10 for more info on our configurations and sizes



Augusta Interior
(Flexible)

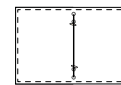

Eyelet Interior
(Flexible)

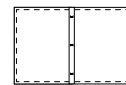

Binder
(Flexible)

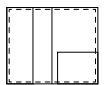

Server Pad Holder
5.5" x 9.25"
(Flexible)

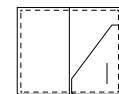

Check Presenter
5" x 8.5"
(Flexible)

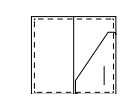

Mini Check Presenter
4" x 7.5"
(Flexible)

Code: **GENUINE** | Minimum: 25 pieces
Handcrafted in the USA



HARLEY

A classic faux leather cover material, the Harley line is perfect for establishments that prioritize cleanliness. The material has antimicrobial, antibacterial properties and the heavy-grain texture adds stylish character for any bar, restaurant, hotel, or senior living facility.

FREE Logo Customization Options:
see pg. 65 for more info



FOIL STAMP



BLIND DEBOSS



FULL COLOR

COLOR SWATCHES

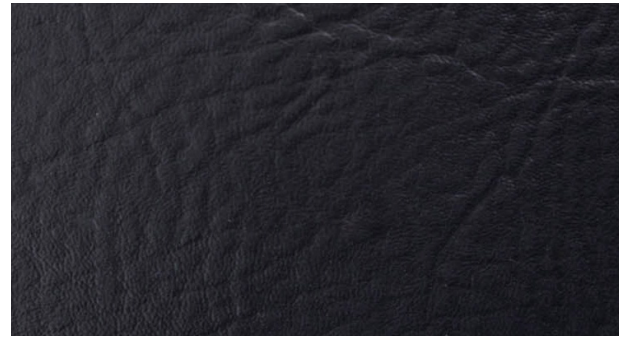

Black

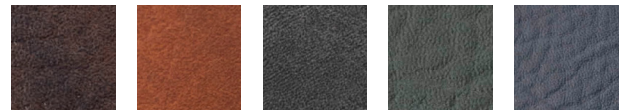

Brown Butterscotch Charcoal Green Navy



Nugget Red White Wine

CONFIGURATIONS

see pgs. 5-10 for more info on our configurations and sizes



Card Interior (Padded)



Pocket Interior (Hardback)

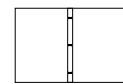

Binder (Padded)



Magnetic Menu Board (Hardback)



Augusta Interior (Padded)

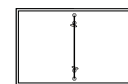

Eyelet Interior (Hardback)



Screwpost Interior (Hardback)



Chicago Menu Board (Hardback)



Table Mat (Hardback)

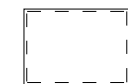

Placemat (Flexible)

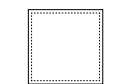

Coaster (Hardback)



Table Tent (Hardback)



Check Presenter (Hardback)

Code: HAR | Minimum: 25 pieces
Handcrafted in the USA



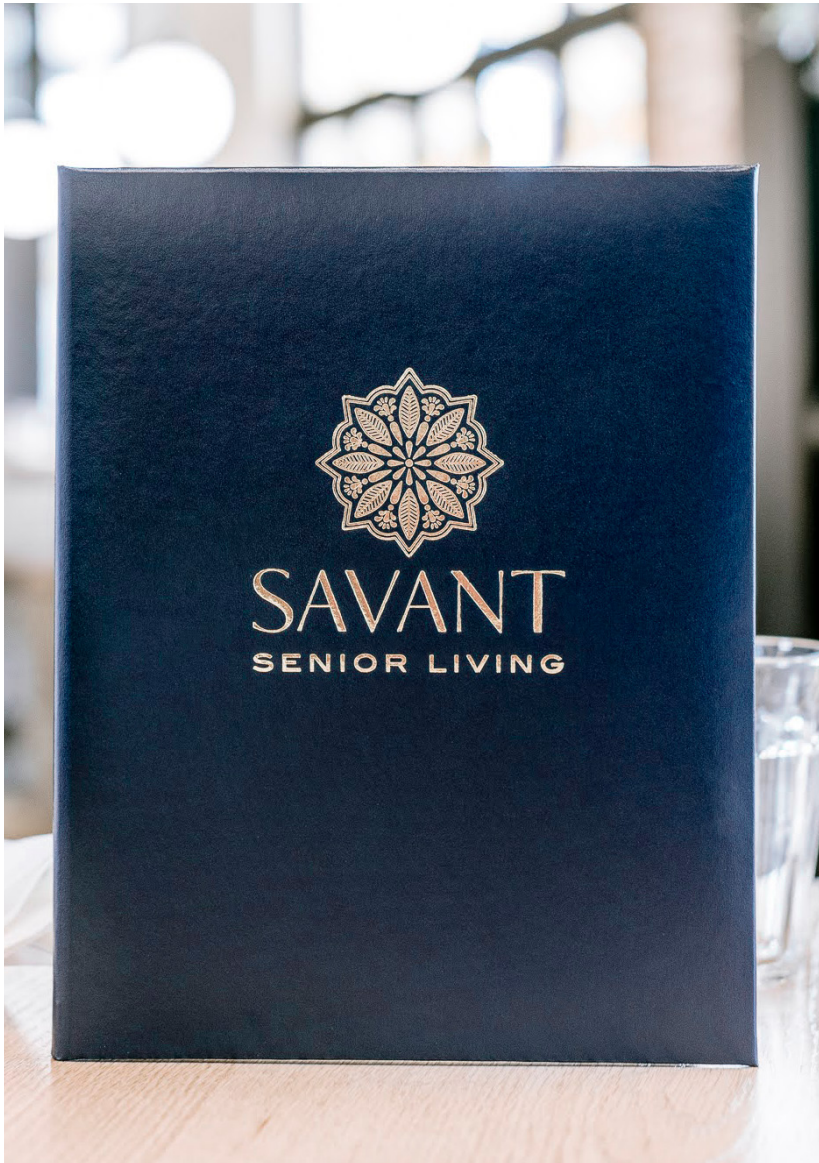

OAKMONT

Tried and true, the Oakmont line is our original cover material line, perfect for first time buyers. The leather-like cover material is highly durable and practical, providing a luxurious and sophisticated appearance. The refined, classical look never goes out of style and complements all environments, from contemporary to traditional.

FREE Logo Customization Options:
see pg. 65 for more info



FOIL STAMP



BLIND DEBOSS



FULL COLOR

COLOR SWATCHES

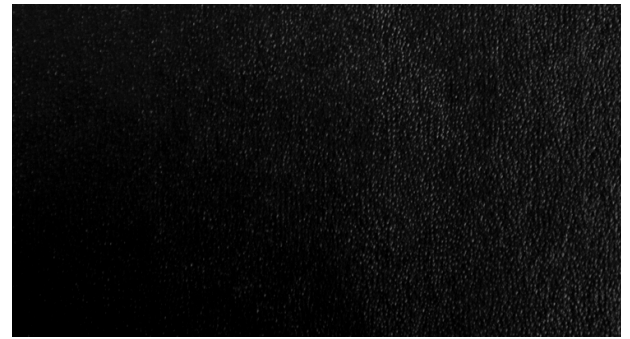

Black

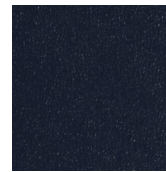

Blue

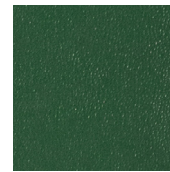

Green



Wine

CONFIGURATIONS

see pgs. 5-10 for more info on our configurations and sizes



Card Interior
(Padded)



Pocket Interior
(Hardback)

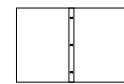

Binder
(Padded)



Magnetic Menu Board
(Hardback)

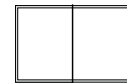

Augusta Interior
(Padded)

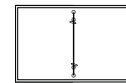

Eyelet Interior
(Hardback)



Screwpost Interior
(Hardback)



Chicago Menu Board
(Hardback)



Table Mat
(Hardback)

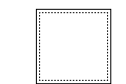

Coaster
(Hardback)



Check Presenter
(Hardback)



Table Tent
(Hardback)

Code: OM | Minimum: 25 pieces
Handcrafted in the USA



COLOR SWATCHES



Bark



Black



Burnt Sienna

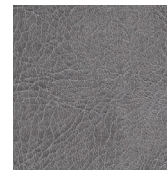

Gray



Green

TAMARAC

The Tamarac is a light-grain, faux leather cover material with a crisp, sharp look. The elegant design exudes a refined and sophisticated aesthetic, perfectly complementing any upscale restaurant or steakhouse. The Tamarac line has timeless qualities making it a versatile choice to provide a luxurious dining experience.

FREE Logo Customization Options:
see pg. 65 for more info



FOIL STAMP



BLIND DEBOSS



FULL COLOR

CONFIGURATIONS

see pgs. 5-10 for more info on our configurations and sizes



Card Interior
(Padded)



Pocket Interior
(Hardback)

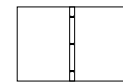

Binder
(Padded)



Magnetic Menu Board
(Hardback)

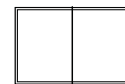

Augusta Interior
(Padded)

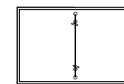

Eyelet Interior
(Hardback)



Screwpost Interior
(Hardback)



Chicago Menu Board
(Hardback)



Table Mat
(Hardback)



Placemat
(Flexible)



Coaster
(Hardback)

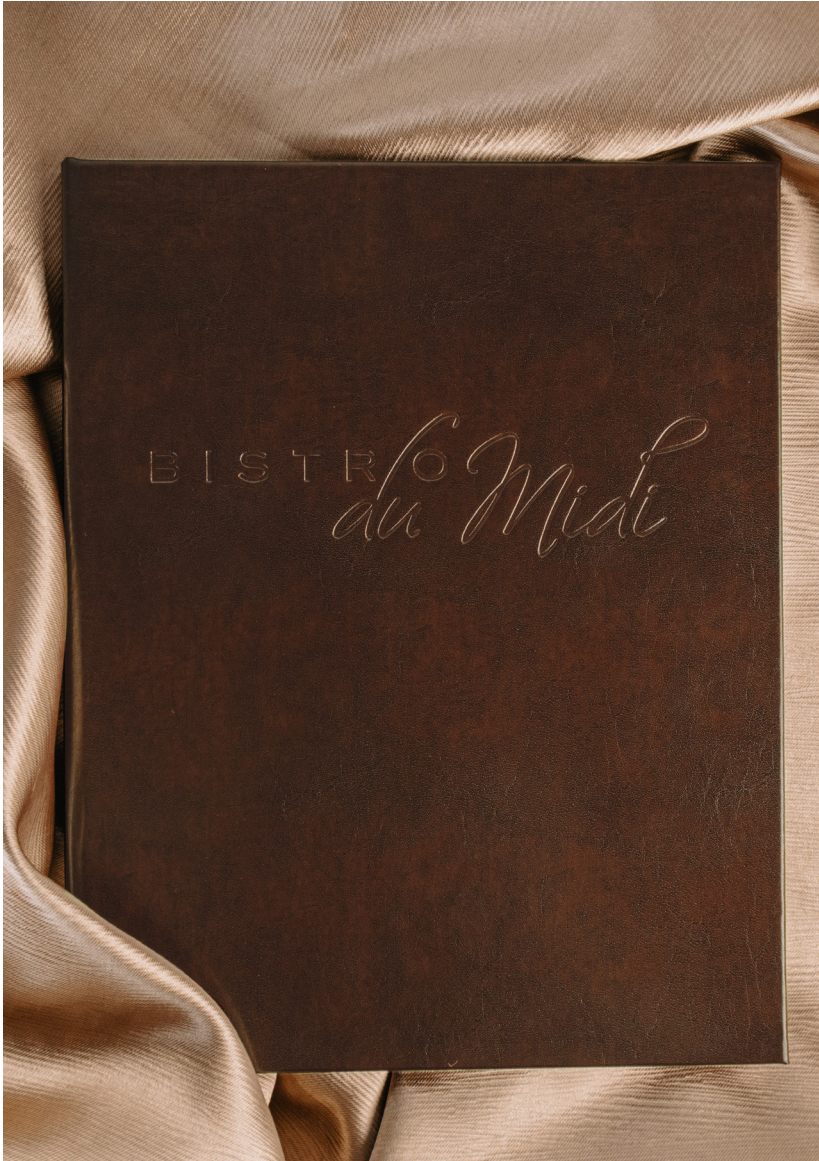

Table Tent
(Hardback)



Check Presenter
(Hardback)

Code: TAM | Minimum: 25 pieces
Handcrafted in the USA



COLOR SWATCHES



Black

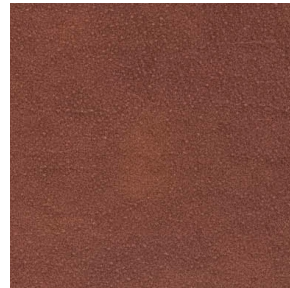

Brown



Wine

TUXEDO LEATHER

The elegance and sophistication of the Tuxedo Leather line gives a refined look to any atmosphere. The glossy, crackled texture of the authentic bonded leather adds character to the surface. Whether you're looking to add a touch of luxury, or simply want to update your current décor, this cover material is the perfect choice.

CONFIGURATIONS

see pgs. 5-10 for more info on our configurations and sizes

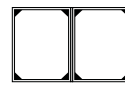

Card Interior
(Padded)



Pocket Interior
(Hardback)

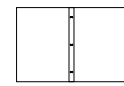

Binder
(Padded)



Magnetic Menu Board
(Hardback)

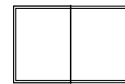

Augusta Interior
(Padded)

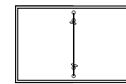

Eyelet Interior
(Hardback)



Screwpost Interior
(Hardback)

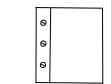

Chicago Menu Board
(Hardback)



Table Mat
(Hardback)



Coaster
(Hardback)



Check Presenter
(Hardback)



Table Tent
(Hardback)

FREE Logo Customization Options:
see pg. 65 for more info



FOIL STAMP



BLIND DEBOSS



FULL COLOR

Code: LTH | Minimum: 25 pieces
Handcrafted in the USA

WOVEN & TEXTURED

Designed to be seen and felt, these woven and textured menu covers add depth and character to your presentation. Rich surfaces and dimensional finishes create a distinctive, tactile experience that enhances any dining atmosphere.





CHESTERFIELD

Rustic and organic styled menu covers that embrace the beauty of wildlife, the Chesterfield's natural hues and textures will make customers feel at home with nature. Crafted with a two-toned, faux ostrich material, this line adds an organic, earthy look that complements any lush or eco-friendly vibe.

FREE Logo Customization Options:
see pg. 65 for more info



FOIL STAMP



FULL COLOR

COLOR SWATCHES



Black

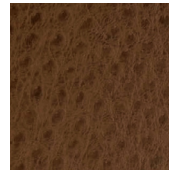

Brown

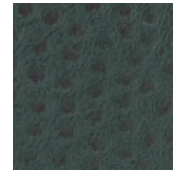

Green



Mahogany

CONFIGURATIONS

see pgs. 5-10 for more info on our configurations and sizes



Card Interior
(Padded)



Pocket Interior
(Hardback)

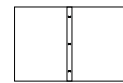

Binder
(Padded)



Magnetic Menu Board
(Hardback)

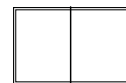

Augusta Interior
(Padded)

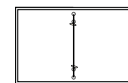

Eyelet Interior
(Hardback)



Screwpost Interior
(Hardback)



Chicago Menu Board
(Hardback)

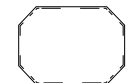
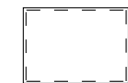
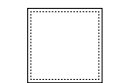

Table Mat
(Hardback)



Placemat
(Flexible)



Coaster
(Hardback)



Table Tent
(Hardback)

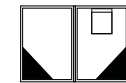

Check Presenter
(Hardback)

Code: CH | Minimum: 25 pieces
Handcrafted in the USA



LINEN

Elevate your dining experience with our premium Linen line. Designed for both sophistication & durability, this material provides a refined touch to any table setting. Its natural texture and subtle sheen make it a perfect fit for restaurants, cafes, and upscale venues.

FREE Logo Customization Options:
see pg. 65 for more info



FOIL STAMP



BURNISHING



FULL COLOR

COLOR SWATCHES



Dune



Espresso



Moss

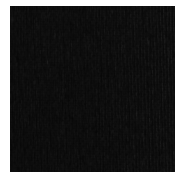

Nero

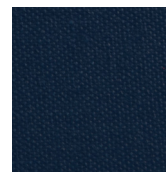

Royal



Stone

CONFIGURATIONS

see pgs. 5-10 for more info on our configurations and sizes



Card Interior
(Hardback)



Pocket Interior
(Hardback)

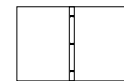

Binder
(Hardback)



Magnetic Menu Board
(Hardback)



Augusta Interior
(Hardback)

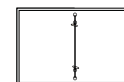

Eyelet Interior
(Hardback)



Screwpost Interior
(Hardback)



Chicago Menu Board
(Hardback)



Check Presenter
(Hardback)

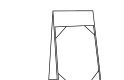
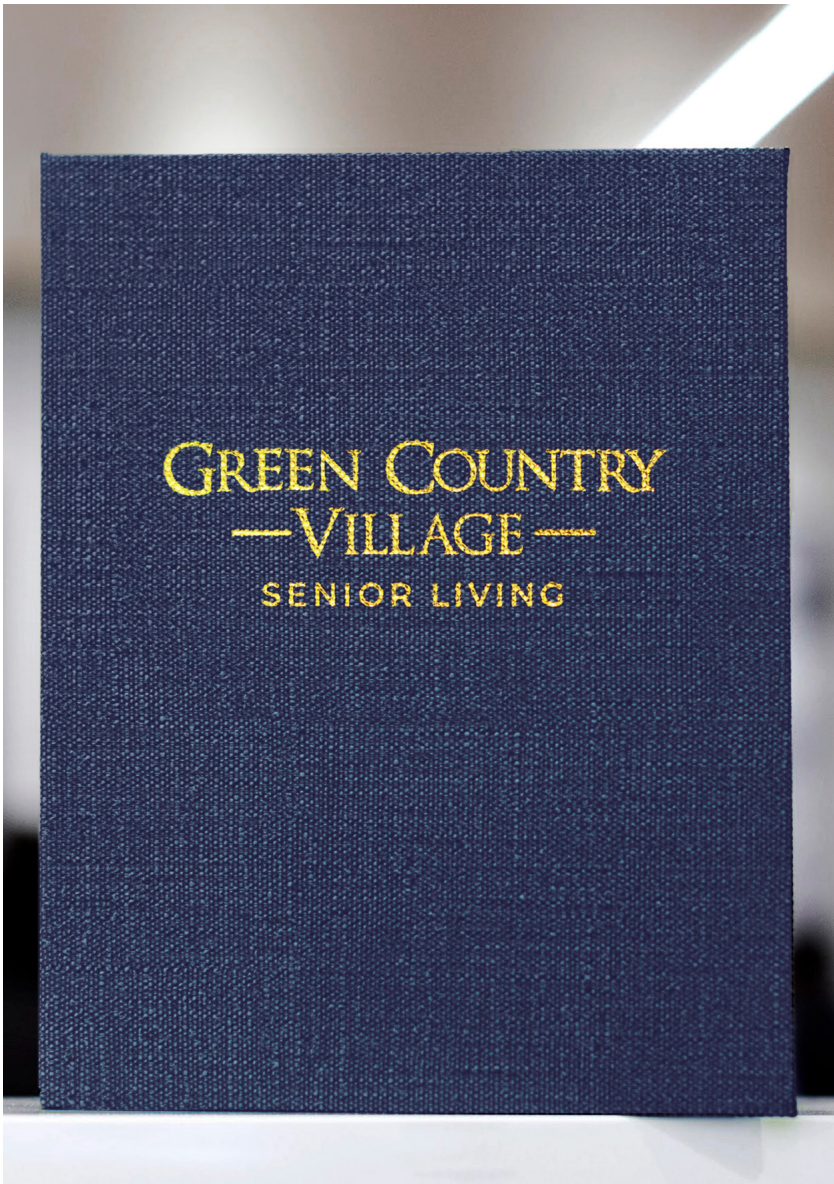

Table Tent
(Hardback)

Code: LINEN | Minimum: 25 pieces
Handcrafted in the USA



MILAN

Feature the beauty of Italy in your space with our Milan line. This imported material has a subtle bird's eye pattern and raised texture, making it naturally stain resistant. Elegant yet practical, this cover material is the perfect accent for anyone looking to upgrade their establishment.

FREE Logo Customization Options:
see pg. 65 for more info



FOIL STAMP



BURNISHING



FULL COLOR

COLOR SWATCHES

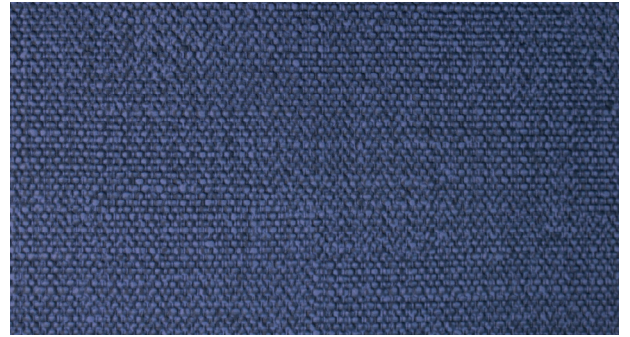

Azure

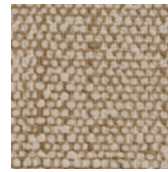

Mineral

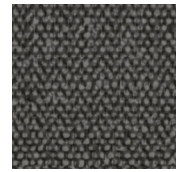

Mystic



Petra

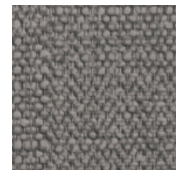

Smoke

CONFIGURATIONS

see pgs. 5-10 for more info on our configurations and sizes



Card Interior
(Hardback)



Pocket Interior
(Hardback)

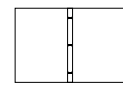

Binder
(Hardback)



Magnetic Menu Board
(Hardback)



Augusta Interior
(Hardback)

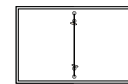

Eyelet Interior
(Hardback)



Screwpost Interior
(Hardback)



Chicago Menu Board
(Hardback)



Table Mat
(Hardback)

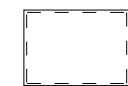

Placemat
(Flexible)

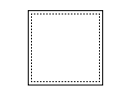

Coaster
(Hardback)

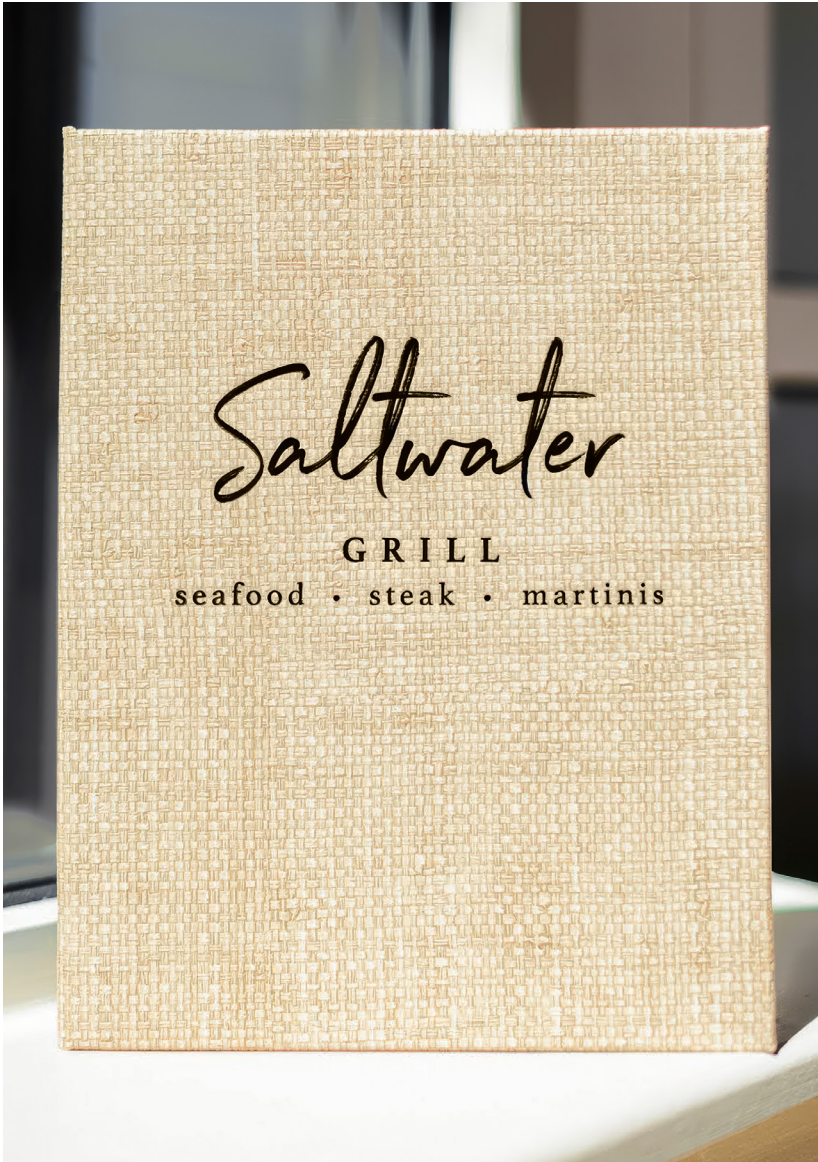

Table Tent
(Hardback)



Check Presenter
(Hardback)

Code: MILAN | Minimum: 25 pieces
Handcrafted in the USA



RATTAN

Lightweight with a basket-woven texture, the Rattan line radiates a clean and minimalistic look inspired by the palms of nature. This cover material offers a unique, earth experience that is perfect for establishments searching for organic textures and colors.

FREE Logo Customization Options:
see pg. 65 for more info



FOIL STAMP - BLACK ONLY



FULL COLOR

COLOR SWATCHES

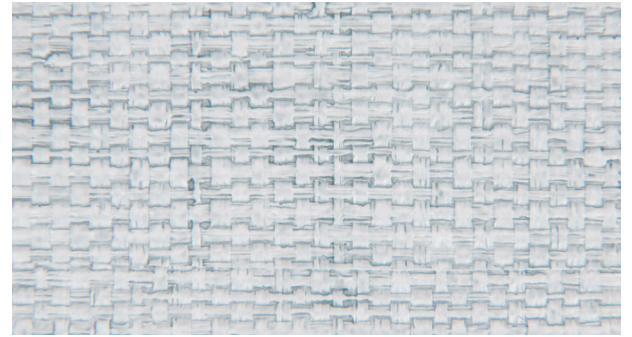

Arctic



Desert

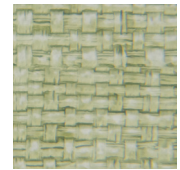

Lemongrass



Mocha

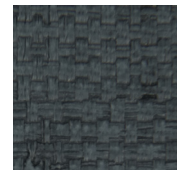

Oxford

CONFIGURATIONS

see pgs. 5-10 for more info on our configurations and sizes



Card Interior
(Hardback)



Pocket Interior
(Hardback)

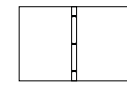

Binder
(Hardback)



Magnetic Menu Board
(Hardback)

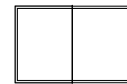

Augusta Interior
(Hardback)

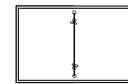

Eyelet Interior
(Hardback)



Screwpost Interior
(Hardback)



Chicago Menu Board
(Hardback)



Table Mat
(Hardback)

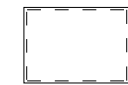

Placemat
(Flexible)

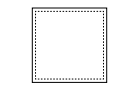

Coaster
(Hardback)

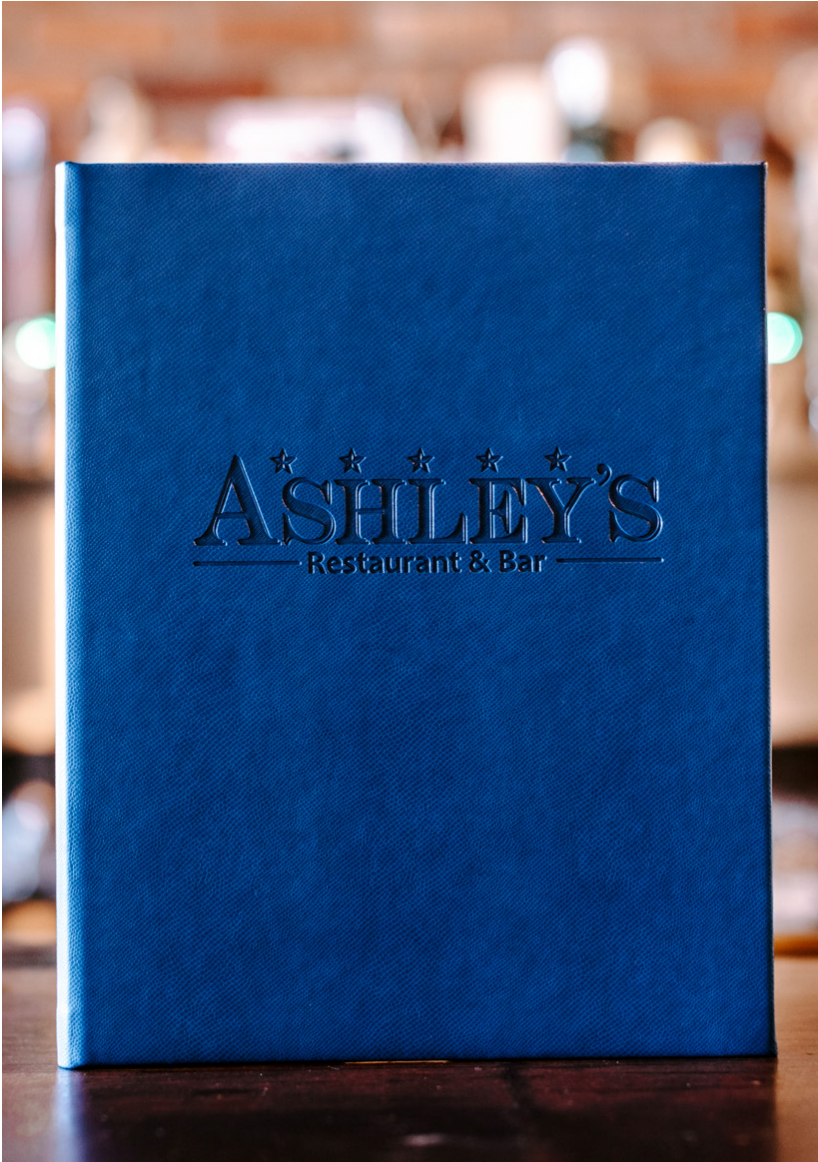

Table Tent
(Hardback)



Check Presenter
(Hardback)

Code: RATTAN | Minimum: 25 pieces
Handcrafted in the USA



RIO

Liven up any atmosphere with the Rio line. The decorative reptilian pattern is sure to catch the eye, while the semi-gloss finish adds a touch of elegance and sophistication to the overall design. Adding a spark of zest to any setting, this bold and stylish cover material lets establishments stand out from the crowd.

FREE Logo Customization Options:

see pg. 65 for more info



FOIL STAMP



BURNISHING



FULL COLOR

COLOR SWATCHES



Black

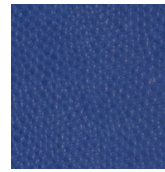

Blue

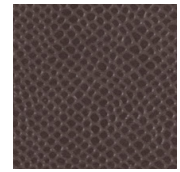

Brown

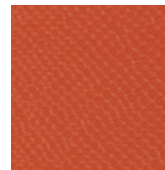

Orange



Red

CONFIGURATIONS

see pgs. 5-10 for more info on our configurations and sizes

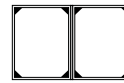

Card Interior
(Hardback)



Pocket Interior
(Hardback)

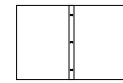

Binder
(Hardback)



Magnetic Menu Board
(Hardback)



Augusta Interior
(Hardback)

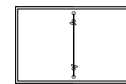

Eyelet Interior
(Hardback)



Screwpost Interior
(Hardback)



Chicago Menu Board
(Hardback)



Table Mat
(Hardback)



Placemat
(Flexible)



Coaster
(Hardback)

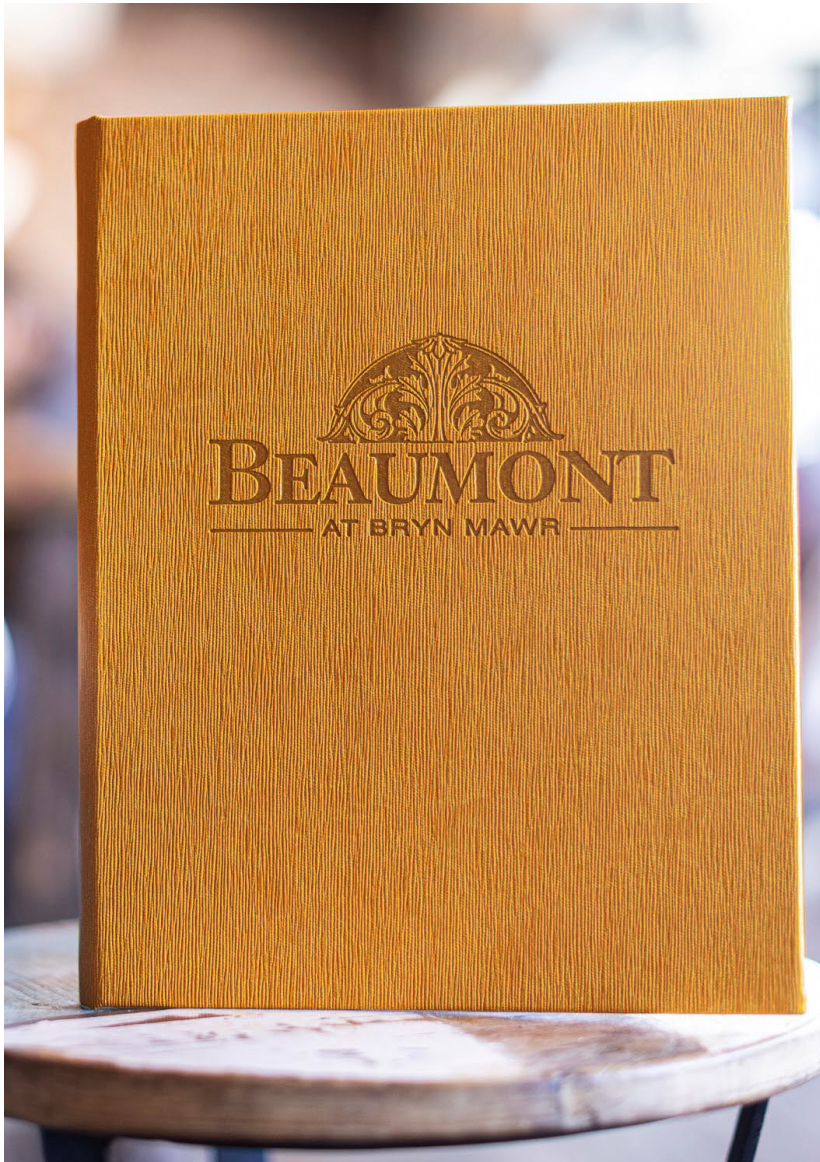

Table Tent
(Hardback)



Check Presenter
(Hardback)

Code: RIO | Minimum: 25 pieces
Handcrafted in the USA



VIENNA

A modern expression of a classic design, the Vienna line is the perfect fashion-forward cover material to liven up any atmosphere. The slightly raised, wave-patterned texture adds visual interest and can be dressed up or down to suit any occasion. From casual to fine dining, this line is sure to turn heads and impress your guests.

FREE Logo Customization Options:
see pg. 65 for more info



FOIL STAMP



BURNISHING



FULL COLOR

COLOR SWATCHES

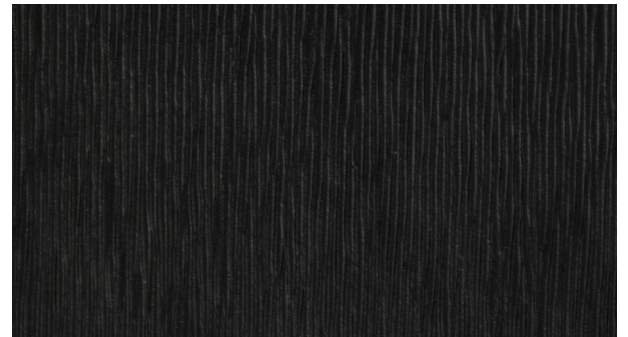

Ebony

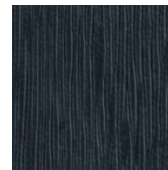

Indigo

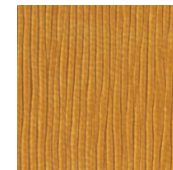

Marigold

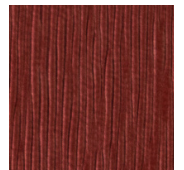

Paprika

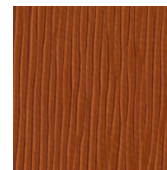

Tangerine



Turquoise

CONFIGURATIONS

see pgs. 5-10 for more info on our configurations and sizes



Card Interior
(Hardback)



Pocket Interior
(Hardback)

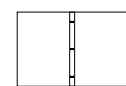

Binder
(Hardback)



Magnetic Menu Board
(Hardback)

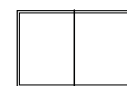

Augusta Interior
(Hardback)

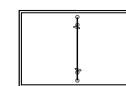

Eyelet Interior
(Hardback)



Screwpost Interior
(Hardback)



Chicago Menu Board
(Hardback)



Table Mat
(Hardback)



Placemat
(Flexible)

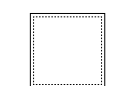

Coaster
(Hardback)



Table Tent
(Hardback)



Check Presenter
(Hardback)

Code: VIENNA | Minimum: 25 pieces
Handcrafted in the USA

NATURAL & ECO INSPIRED

Bring warmth and authenticity to the table with nature-inspired menu covers. Organic textures and materials create a grounded, inviting presence that reflects thoughtful design and a connection to natural elements.





AUTHENTIC WOOD

The Authentic Wood line combines the enduring beauty of nature with the elegance of the Tuxedo Leather. Its rich, warm wooden exterior is carefully crafted to highlight the grain, which gives a unique character to each cover. The refined natural look of this line is perfect for spaces that want a luxurious and welcoming atmosphere.

FREE Logo Customization Options:
see pg. 65 for more info



LASER ENGRAVING

COLOR SWATCHES

WOOD



Ash

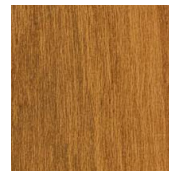

Cherry



Coffee

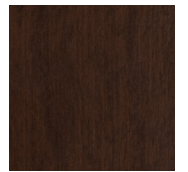

Mahogany



Maple



Walnut

TUXEDO LEATHER BACK, SPINE, & CORNERS



Black

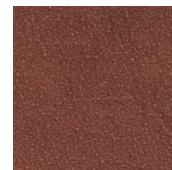

Brown

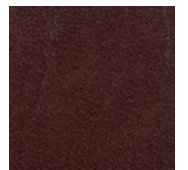

Wine

CONFIGURATIONS

see pgs. 5-10 for more info on our configurations and sizes



Card
Interior
(Hardback)



Check
Presenter
(Hardback)

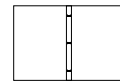

Binder
(Hardback)



Chicago Menu
Board
(Hardback)

Code: **WOOD** | Minimum: 25 pieces
Handcrafted in the USA



EVERGREEN

Vegan and eco-friendly, the Evergreen line is a perfect addition to any restaurant that prioritizes sustainability. Crafted from recycled natural fibers, this two-toned, softly textured material is not only environmentally conscious but also looks and feels luxurious to the touch.

FREE Logo Customization Options:
see pg. 65 for more info



FOIL STAMP



BURNISHING



FULL COLOR

COLOR SWATCHES



Currant

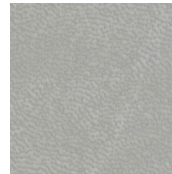

Graphite

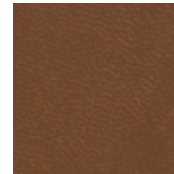

Hazelwood



Midnight

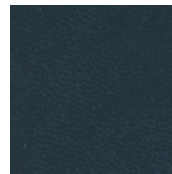

Ontario



Sandstone



Terrain

CONFIGURATIONS

see pgs. 5-10 for more info on our configurations and sizes



Card Interior
(Hardback)



Pocket Interior
(Hardback)

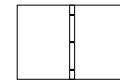

Binder
(Hardback)



Magnetic Menu Board
(Hardback)



Augusta Interior
(Hardback)

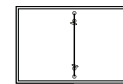

Eyelet Interior
(Hardback)



Screwpost Interior
(Hardback)



Chicago Menu Board
(Hardback)



Table Mat
(Hardback)



Placemat
(Flexible)

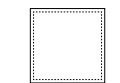

Coaster
(Hardback)



Table Tent
(Hardback)



Check Presenter
(Hardback)

Code: **EVERGREEN** | Minimum: 25 pieces
Handcrafted in the USA



SHERWOOD

Give your establishment a touch of rustic charm with the Sherwood line. This faux-wood cover material embodies a warm and homey feel with its authentic wood grain. It's perfect for spaces looking to capture a country, farmhouse, or vintage aesthetic.

FREE Logo Customization Options:
see pg. 65 for more info



FOIL STAMP



BURNISHING



FULL COLOR

COLOR SWATCHES



Buff

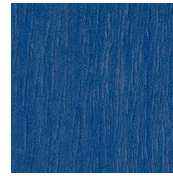

Cobalt



Maple



Rustic

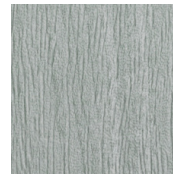

Seafoam

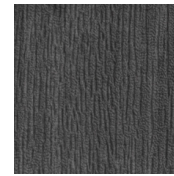

Shadow



Walnut

CONFIGURATIONS

see pgs. 5-10 for more info on our configurations and sizes



Card Interior
(Hardback)



Pocket Interior
(Hardback)

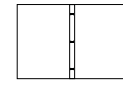

Binder
(Hardback)



Magnetic Menu Board
(Hardback)

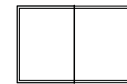

Augusta Interior
(Hardback)

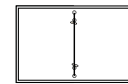

Eyelet Interior
(Hardback)



Screwpost Interior
(Hardback)



Chicago Menu Board
(Hardback)



Table Mat
(Hardback)



Placemat
(Flexible)



Coaster
(Hardback)



Table Tent
(Hardback)



Check Presenter
(Hardback)

Code: SHERWOOD | Minimum: 25 pieces
Handcrafted in the USA



VINO

Simple yet elegant, the VINO line is a perfect blend of durability, elegance, and sustainability. This material's organic and cultured look will never go out of style. Crafted from a smooth, faux-cork material, the VINO is durable and resistant to the flaking, crumbling, and cracking that occurs with real cork.

FREE Logo Customization Options:
see pg. 65 for more info



FOIL STAMP



BLIND DEBOSS



FULL COLOR

COLOR SWATCHES



Cocoa

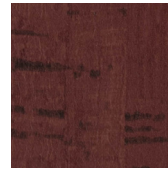

Malbec

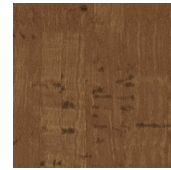

Napa



Natural



Slate



Vintage

CONFIGURATIONS

see pgs. 5-10 for more info on our configurations and sizes



Card Interior
(Padded)



Pocket Interior
(Hardback)

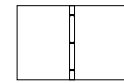

Binder
(Padded)



Magnetic Menu Board
(Hardback)

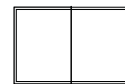

Augusta Interior
(Padded)

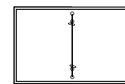

Eyelet Interior
(Padded)



Screwpost Interior
(Padded)

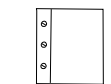

Chicago Menu Board
(Hardback)



Table Mat
(Hardback)



Placemat
(Flexible)

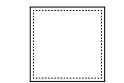

Coaster
(Hardback)



Table Tent
(Hardback)



Check Presenter
(Hardback)

Code: VINO | Minimum: 25 pieces
Handcrafted in the USA

METALLIC FINISHES

Make a bold first impression with menu covers featuring striking metallic finishes. These materials deliver a sleek, upscale look that adds sophistication and visual impact to your presentation.



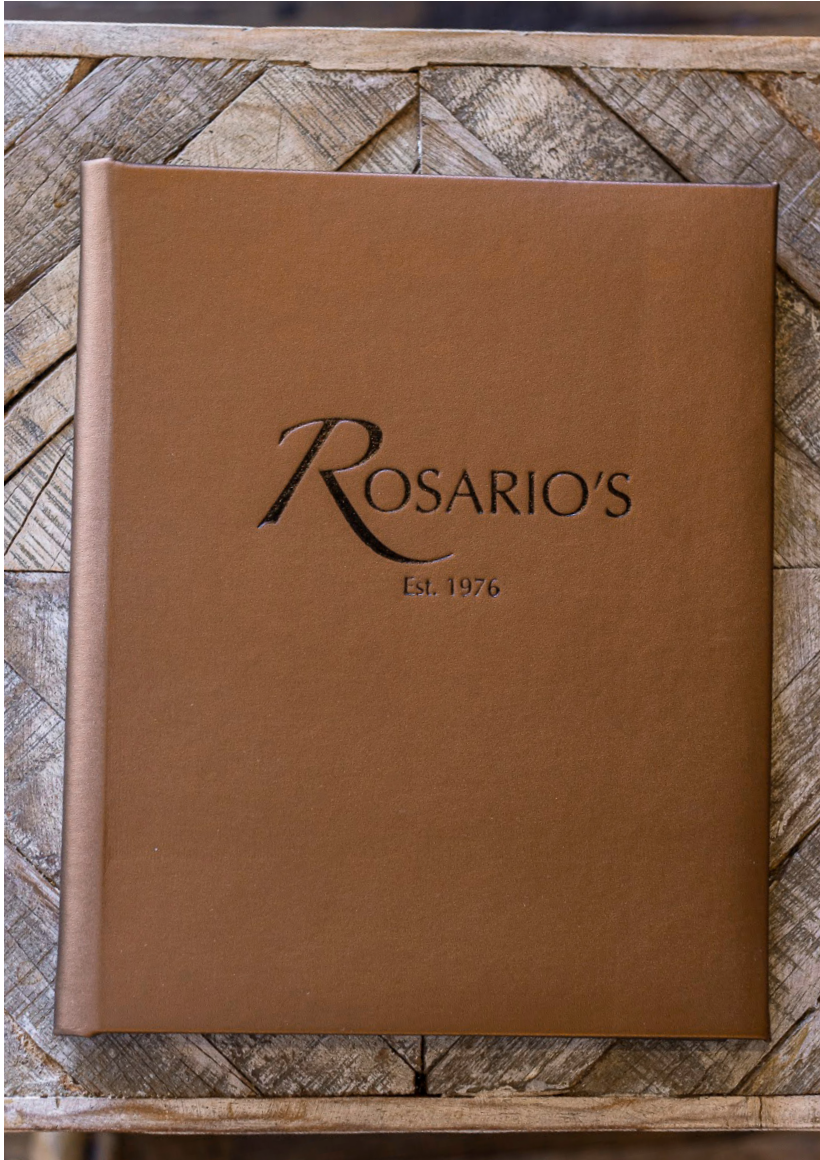

IRIDESCENT

Draw eyes to your menu presentations with the contemporary and ultra-chic Iridescent line, inspired by the striking colors of nature. Crafted with a shimmery grained material featuring cool, earthy tones, this cover material conveys a bold and edgy statement. The Iridescent is great for establishments looking to add a hint of color and texture.

FREE Logo Customization Options:
see pg. 65 for more info



FOIL STAMP



FULL COLOR

COLOR SWATCHES



Aubergine

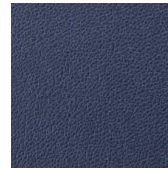

Blue



Chocolate



Copper



Silver



Taupe

CONFIGURATIONS

see pgs. 5-10 for more info on our configurations and sizes



Card Interior
(Padded)



Pocket Interior
(Hardback)

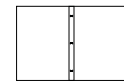

Binder
(Padded)



Magnetic Menu Board
(Hardback)



Augusta Interior
(Padded)

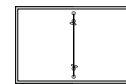

Eyelet Interior
(Hardback)



Screwpost Interior
(Hardback)

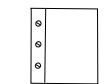

Chicago Menu Board
(Hardback)



Table Mat
(Hardback)

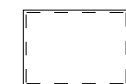

Placemat
(Flexible)



Coaster
(Hardback)

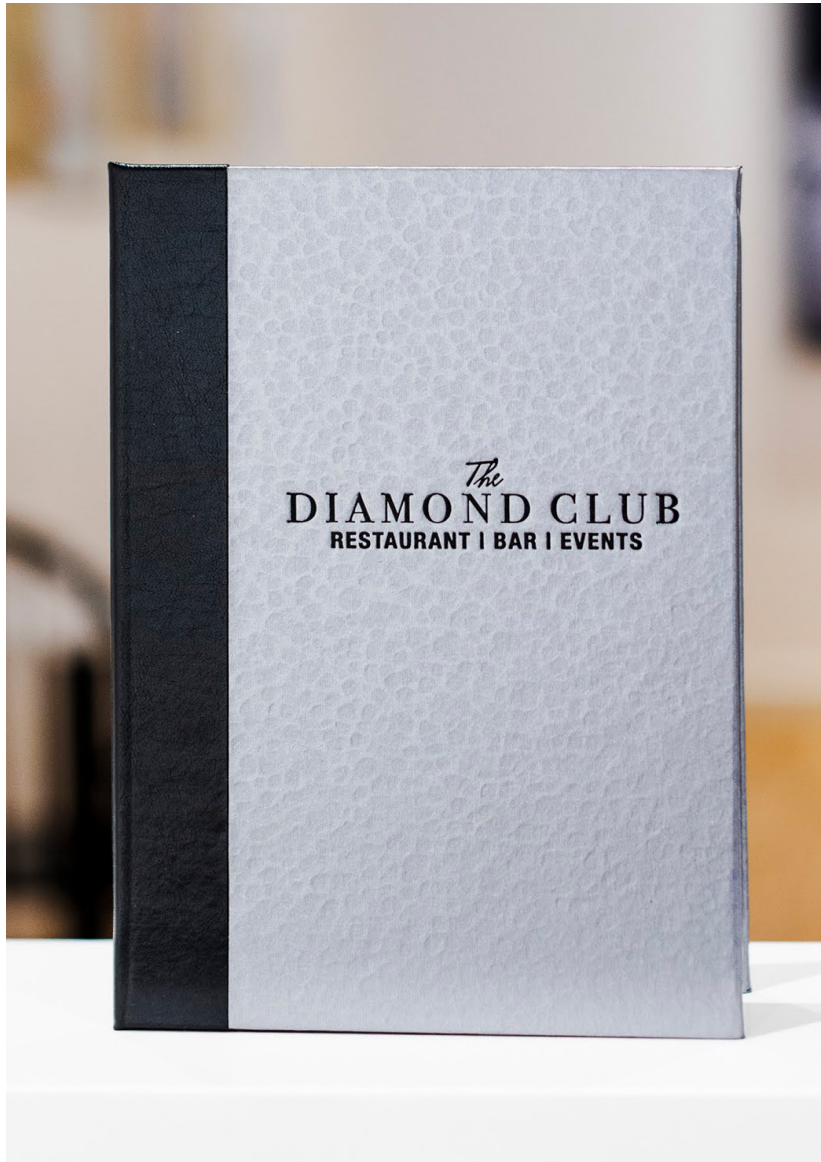

Table Tent
(Hardback)



Check Presenter
(Hardback)

Code: IRI | Minimum: 25 pieces
Handcrafted in the USA



METRO

Embody a sleek and modern feel with the Metro line.

Metro Iron is perfect for those seeking a metallic aesthetic without the shimmer. The hammered texture creates a look that is both strong and sleek, but more casual than traditional metals.

Metro Mesh blends the classic linen look with a modern, edgy aesthetic. The multi-color weave gives it a subtle metallic shine, creating a statement piece that works with all décor.

FREE Logo Customization Options:
see pg. 65 for more info



FOIL STAMP



FULL COLOR

COLOR SWATCHES

METRO MESH



Bronze

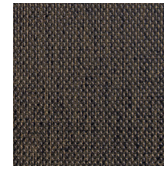

Gold

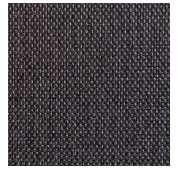

Silver

METRO IRON



Brass



Copper



Gold Dust

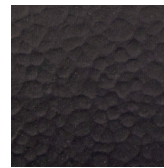

Onyx



Platinum

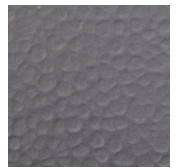

Steel

TUXEDO LEATHER SPINE



Black

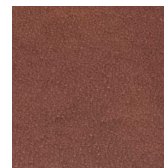

Brown

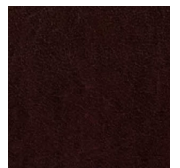

Wine

CONFIGURATIONS

see pgs. 5-10 for more info on our configurations and sizes



Card Interior
(Hardback)



Pocket Interior
(Hardback)



Augusta Interior
(Hardback)

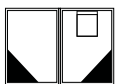

Check Presenter
(Hardback)

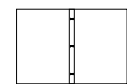

Binder
(Hardback)

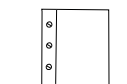

Chicago Menu Board
(Hardback)

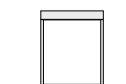

Magnetic Menu Board
(Hardback)

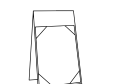

Table Tent
(Hardback)



Gatsby Clipboard
(Hardback)

Code: METRO | Minimum: 25 pieces
Handcrafted in the USA



PATINA

Colorful, vibrant Patina Copper, paired with our Tuxedo Leather spine and backing, creates a one-of-a-kind, upscale design that is unlike any other. Each unique cover showcases the natural copper variations, meaning no two menus are the same. This stunning line is sure to draw both eyes and cameras, and will keep your customers talking.

FREE Logo Customization Options:
see pg. 65 for more info



EMBOSS

COLOR SWATCHES

PATINA COPPER

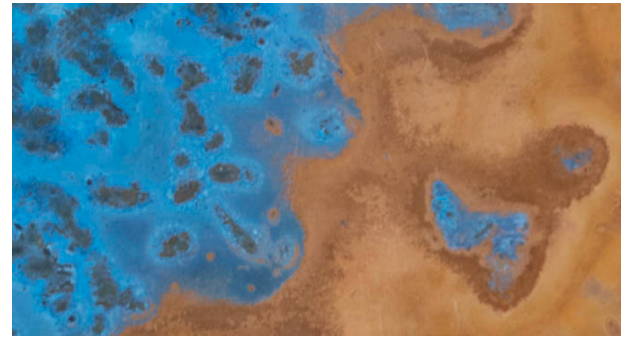

Azul

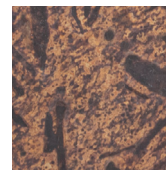

Distressed



Rojo Y Negro

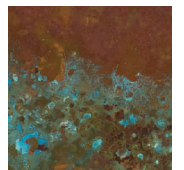

Rojo



Sunburst

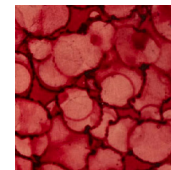

Sangria

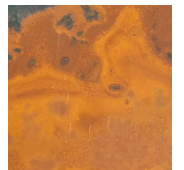

Verde

TUXEDO LEATHER BACK & SPINE



Black

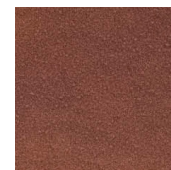

Brown

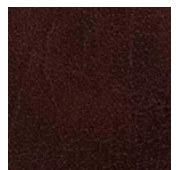

Wine

CONFIGURATIONS

see pgs. 5-10 for more info on our configurations and sizes



Card Interior
(Hardback)



Check Presenter
(Hardback)

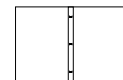

Binder
(Hardback)



Chicago Menu Board
(Hardback)

Code: PATINA | Minimum: 25 pieces
Handcrafted in the USA





STERLING

The Sterling line is sure to impress your guests with its unique, gem-like shimmering tones. The cover material reflects light in a way that creates a stunning, eye-catching visual effect while the silky sheen finish adds a touch of elegance and sophistication to the overall design.

COLOR SWATCHES

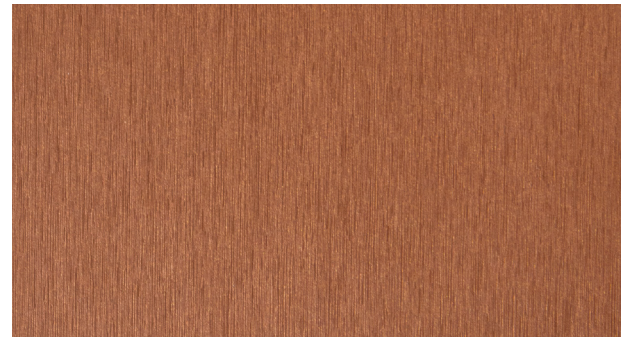

Copper



Gunmetal



Nickel



Twilight

CONFIGURATIONS

see pgs. 5-10 for more info on our configurations and sizes



Card Interior
(Hardback)



Pocket Interior
(Hardback)



Binder
(Hardback)



Magnetic Menu Board
(Hardback)

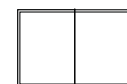

Augusta Interior
(Hardback)

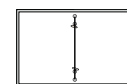

Eyelet Interior
(Hardback)

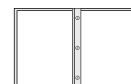

Screwpost Interior
(Hardback)



Chicago Menu Board
(Hardback)



Table Tent
(Hardback)



Check Presenter
(Hardback)

FREE Logo Customization Options:
see pg. 65 for more info



FOIL STAMP



BURNISHING



FULL COLOR

Code: **STERLING** | Minimum: 25 pieces
Handcrafted in the USA

FORMAT SHOWCASE

Explore a wide range of menu formats designed for flexibility and function. From clipboards to binders, each configuration supports easy updates while complementing your brand and enhancing everyday usability.



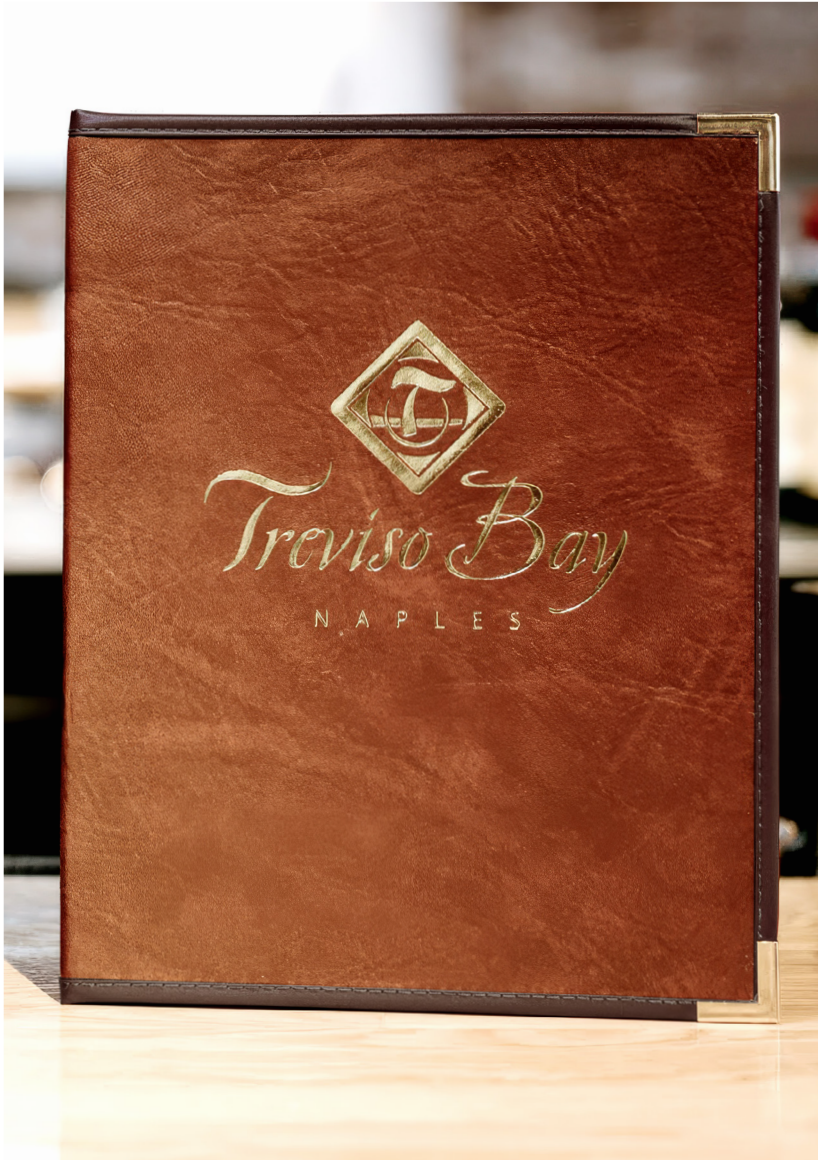

SEVILLE

The Seville line is the perfect choice for those looking for a sturdy and stylish menu. The durable hardboard, stitched binding edges and metal corners provide a professional finish while protecting your menu from wear and tear.

Seville (Code: SEV) comes with pocket interior.
Seville Deluxe (Code: SEV DX) comes with card interior.

FREE Logo Customization Options:
see pg. 65 for more info



FOIL STAMP



BLIND DEBOSS



FULL COLOR

COLOR SWATCHES

HARLEY WITH MATCHING TRIM

Matching trim comes standard for these colors, other trim colors available upon request.

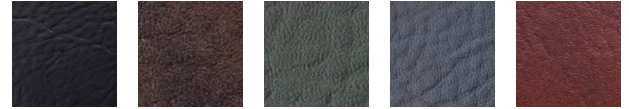

Black

Brown

Green

Navy

Wine

HARLEY WITH BLACK TRIM

Black trim comes standard for these colors, other trim colors available upon request.



Butterscotch

Charcoal

Nugget

Red

White

LEATHERETTE TRIM SWATCHES



Black

Blue

Brown

Green

Wine

CORNER OPTIONS



Black
Corner K



Gold
Corner E



Silver
Corner F

AVAILABLE SIZES

4.25" x 11", 4.25" x 14", 5.5" x 8.5", 8.5" x 11", 8.5" x 14", Custom

Code: SEV or SEV DX | Minimum: 25 pieces
Handcrafted in the USA





GATSBY CLIPBOARD

The Gatsby clipboard is a chic and modern way to display your drinks or specials to guests. Made from sturdy board with a silver clip, wrapped with your choice of Metro material, the Gatsby is both stylish and functional. With its sleek design and easy-to-use features, it is the perfect way to elevate your presentation and impress your guests.

FREE Logo Customization Options:
see pg. 65 for more info



FOIL STAMP



FULL COLOR

COLOR SWATCHES

METRO MESH

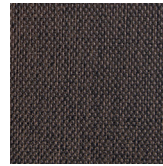

Bronze



Gold

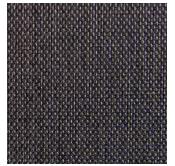

Silver

METRO IRON

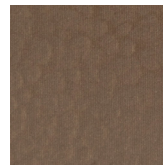

Brass



Copper



Gold Dust

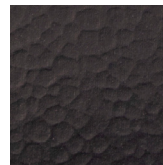

Onyx



Platinum

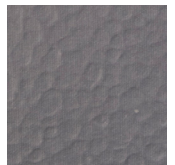

Steel

CLIP OPTIONS



Silver
(Standard)



Antique



Black

AVAILABLE SIZES

4.25" x 11", 4.25" x 14", 5.5" x 8.5", 8.5" x 11", 8.5" x 14", 11" x 17"

Code: **GATSBY** | Minimum: 25 pieces
Handcrafted in the USA





AUGUSTA

The Augusta is a classic and stylish way to present your menu to your guests. Made in over 15 materials, the Augusta cover comes in a variety of colors to match your restaurant's décor. It comes in many configurations prioritizing convenience, so it is always easy to add or remove pages as needed.

Minimum: 25 pieces | Handcrafted in the USA

FREE Logo Customization options differ by material

See pg. 65 for more info.

See pg. 58 for elastic customization options.

AUGUSTA BANDED

Code: **AUGUSTA**

Elastics sold separately, customizable upon request. See pg. 63 for details of available elastic colors and sizes.



AUGUSTA EYELET

Code: **EYELET**

Metal eyelets and barbed elastics allow for a seamless, concealed construction. Eyelets, elastics, and bars customizable upon request.



AUGUSTA SCREWPOST

Code: **AUG3POST**

This hardback menu cover comes standard with a black interior and black 3/8" screwpost hardware which is not visible on the front cover.

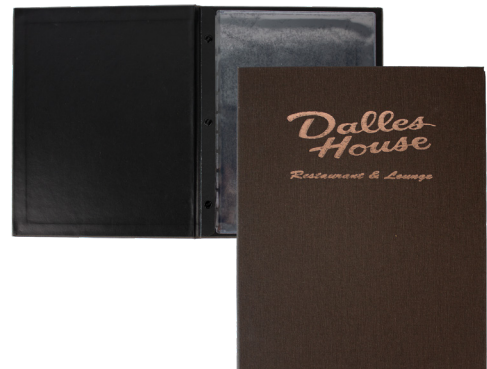



PINEHURST 3-RING BINDER

Code: **PINE3RING**

Comes with a 1/2" silver 3-ring mechanism. Black 3-ring mechanism available upon request.



CHICAGO MENU BOARD

Code: **CMBFF**

Produced standard with a black interior and 3/8" black screw-posts.

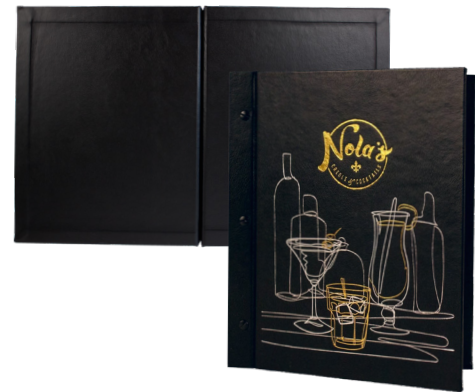

BINDER

Binders are a unique and versatile solution for your menu presentation. Both screwpost binder and 3-ring binder designs offer the flexibility of adding or removing pages with ease. Binders are available in a large variety of sizes and customizable materials.

All styles hold up to 12 clear vinyl page protectors (Sold separately).

Minimum: 25 pieces | Handcrafted in the USA

FREE Logo Customization options differ by material

See pg. 65 for more info.

WOOD CHICAGO MENU BOARD

Code: **CMBFF-WOOD**

Authentic wood front panel comes standard with black leather spine, back, and exterior corners, black interior, and 3/8" black screw posts.



MATERIAL BOUND BACKLIT MENUS

Create a dramatic table presentation with LED backlit menus. An integrated lighting system illuminates menu pages from behind, making them easy to read in dimly lit restaurants, lounges, and bars while adding a modern, high-end touch that enhances the overall dining experience.

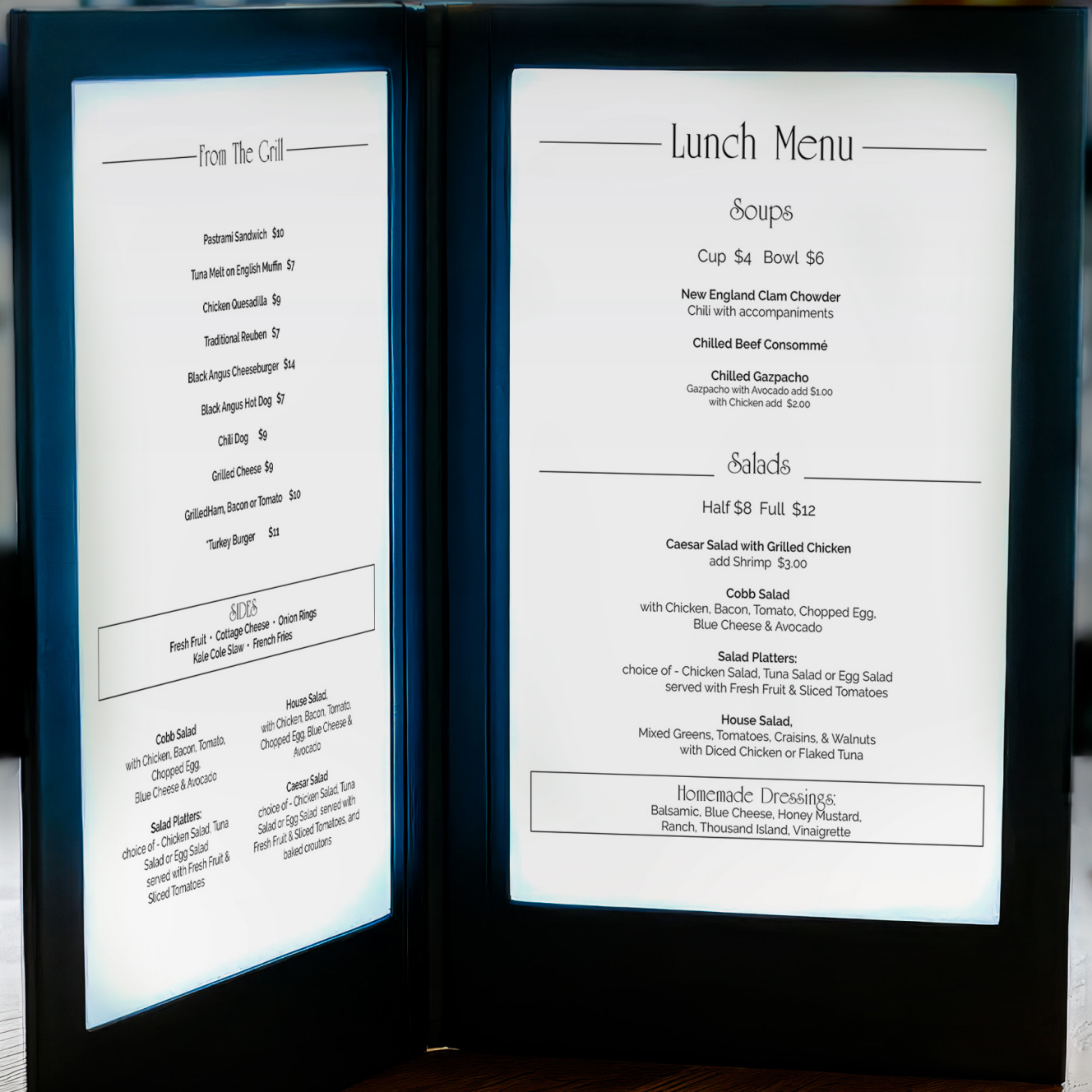

From The Grill

- Pastrami Sandwich \$10
- Tuna Melt on English Muffin \$7
- Chicken Quesadilla \$9
- Traditional Reuben \$7
- Black Angus Cheeseburger \$14
- Black Angus Hot Dog \$7
- Chili Dog \$9
- Grilled Cheese \$9
- Grilled Ham, Bacon or Tomato \$10
- Turkey Burger \$11

SIDES

Fresh Fruit • Cottage Cheese • Onion Rings
Kale Cole Slaw • French Fries

- Cobb Salad**
with Chicken, Bacon, Tomato,
Chopped Egg,
Blue Cheese & Avocado
- House Salad**
with Chicken, Bacon, Tomato,
Chopped Egg, Blue Cheese &
Avocado
- Caesar Salad**
choice of - Chicken Salad, Tuna
Salad or Egg Salad served with
Fresh Fruit & Sliced Tomatoes, and
baked croutons
- Salad Platters:**
choice of - Chicken Salad, Tuna
Salad or Egg Salad
served with Fresh Fruit &
Sliced Tomatoes

Lunch Menu

Soups

Cup \$4 Bowl \$6

New England Clam Chowder
Chili with accompaniments

Chilled Beef Consommé

Chilled Gazpacho
Gazpacho with Avocado add \$1.00
with Chicken add \$2.00

Salads

Half \$8 Full \$12

Caesar Salad with Grilled Chicken
add Shrimp \$3.00

Cobb Salad
with Chicken, Bacon, Tomato, Chopped Egg,
Blue Cheese & Avocado

Salad Platters:
choice of - Chicken Salad, Tuna Salad or Egg Salad
served with Fresh Fruit & Sliced Tomatoes

House Salad,
Mixed Greens, Tomatoes, Craisins, & Walnuts
with Diced Chicken or Flaked Tuna

Homemade Dressings:
Balsamic, Blue Cheese, Honey Mustard,
Ranch, Thousand Island, Vinaigrette



8.5" x 14" 2 View LED Menu Cover with LED Paper Inserts

LED BACKLIT INTERIOR

CONFIGURATIONS

Print options dependent on material selected. See pgs. 5-10 for more info on our sizes, configurations and print option availability.

STANDARD BLACK FAUX LEATHER



1 View (Hardback)



2 View (Hardback)

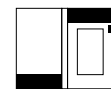

Check Presenter (Hardback)

MATERIAL BOUND

Available in a wide variety of materials for an additional charge. See page 10 for a chart of available custom materials.



2 View (Hardback)

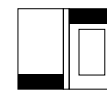

Check Presenter (Hardback)

ACCESSORIES



CHARGING STATION
Product Code: LED-CS
12 Port USB charging strip.



LED PAPER
Product Code: LED PAPER
LED Paper recommended. The translucent paper can be used in laser/ink jet printers. Sold in packs of 20.

FREE Logo Customization Options for Standard Black Faux Leather:
see pg. 65 for more info



FOIL STAMP



BLIND DEBOSS



FULL COLOR

Code: LED | Minimum: 25 pieces
Handcrafted in the USA





COLOR SWATCHES

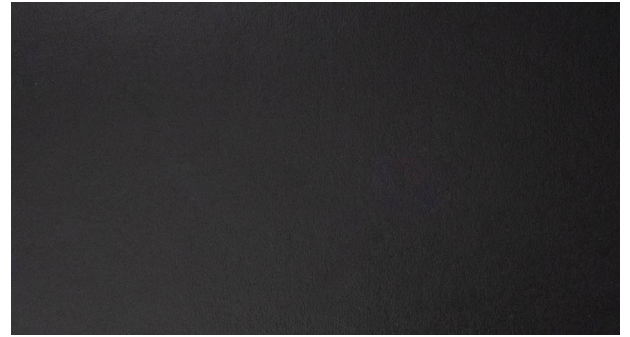

Black



Blue



Green



Wine

CORNER OPTIONS

Available for Sewn Pajco only.



Gold
Corner C



Silver
Corner D



Black
Corner J

CONFIGURATIONS



SEWN PAJCO

Code: 2001 to 2012

Available up to 12 views.



PAJCO SPIRAL

⚠ Code: PAJCO-SP

Available up to 24 views.
Additional pages available
for purchase.

PAJCO

Both of our Pajco covers are made with a semi-flexible vinyl material that comes in 4 neutral colors.

Our Sewn Pajco cover is produced with a clear sewn pocket interior, coordinating colored trim, and smooth metal corners.

Our Pajco Spiral is produced with a black spiral and is available with up to 24 views.

FREE Logo Customization Options:
see pg. 65 for more info



FOIL STAMP



FULL COLOR

Code: 2001-2012/PAJCO-SP | Minimum: 25 pieces
Handcrafted in the USA



H2O

Made from semi-flexible, waterproof vinyl cards, the H2O covers offer a waterproof, durable alternative for your menu covers in either full color or black and white. Available in 2 to 12 views. For any covers over 2 views, the menu is bound together with a black spiral.

- ⚠ Code: H2O
- Made in the USA
- Minimum: 25 pieces



WATERPROOF TEAR-PROOF PAPER

Long-lasting, affordable and durable, the Waterproof Tear-Proof paper is the perfect solution for high traffic establishments. The paper is easy to clean and sanitize. Single, Bi-Fold and Tri-Fold options available. Please note the Bi-Fold and Tri-Fold options do not lay completely flat. 10 mil and 14 mil paper options available.

- ⚠ Code: SYNTHETIC-MENU
- Made in the USA
- Minimum: 25 pieces

VINYL MENU COVERS

Designed for busy environments, vinyl menu covers offer durability, protection, and easy maintenance. Clear and classic styles provide full visibility and a clean, streamlined look across a variety of sizes and configurations.





ALL CLEAR VINYL MENU COVERS

These durable, 8-gauge all-clear vinyl pocket menus provide excellent visibility of your food and drink selections and are easy to clean and sanitize.

Bold sizes are available in a thicker 12-gauge vinyl.

Minimum: 3 Packs (24 Units Per Pack) | Made in the USA



Code: 100



Code: 200

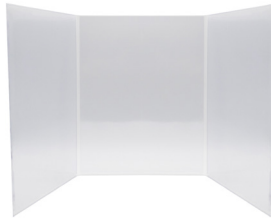

Code: 300



Code: 61



Code: 81

AVAILABLE SIZES

- 4.25" x 11"
- 4.25" x 14"
- 5.5" x 8.5"
- 8.5" x 11"**
- 8.5" x 14"**
- 11" x 17"**

AVAILABLE SIZES

- 5.5" x 8.5"
- 8.5" x 11"**
- 8.5" x 14"**

AVAILABLE SIZES

- 5.5" x 8.5"
- 8.5" x 11"
- 8.5" x 14"

AVAILABLE SIZES

- 5.5" x 8.5"
- 8.5" x 11"
- 8.5" x 14"

AVAILABLE SIZES

- 8.5" x 11"
- 8.5" x 14"



BLACK VINYL MENU COVER

Code: 700 | Minimum: 2 Dozen | Made in the USA

Slight grained, flexible, black vinyl cover with heat-sealed edges. Stiffened with tag board interior. Available with "Menu" printed in gold foil or no print. Customization options available for upcharge.

AVAILABLE SIZES

5.5" x 8.5", 8.5" x 11"



TUSCAN MENU BOARD

⚠ Code: TMB | Minimum: 2 Dozen | Made in the USA

Black, heat-sealed hardboard with clear pockets on front and back.

AVAILABLE SIZES

8.5" x 11", 8.5" x 14", 11" x 17"



ALL CLEAR SPIRAL MENU COVER

⚠ Code: SPIRALBOUND | Minimum: 25 pieces | Made in the USA

Heat-sealed, all-clear vinyl pages bound with a black spiral. Sold with up to 12 side-loading pages (24 viewing sides).

AVAILABLE SIZES

4.25" x 11", 4.25" x 14", 5.5" x 8.5", 8.5" x 11", 8.5" x 14"



STARTERS

CHICKEN WINGS

Four fresh wings, tossed in mild, medium, hot, or spicy sauce. Add optional Parmesan, Cajun, Buffalo, or Honey Mustard. Full Order 12.00

MOZZARELLA STICKS
 Fresh mozzarella sticks, breaded, fried, and served with a side of marinara sauce. 9.00

PRETZELS & BEER CHEESE
 Four warm, soft pretzels, breaded & topped with beer and cheese sauce. 11.00

FRIED CALAMARI
 Four pieces of calamari, breaded & fried. Served with a remouillage sauce. 11.00

CHICKEN FINGERS
 Five pieces of chicken, breaded & fried. Served with a choice of sauce: honey mustard, BBQ, buffalo wing, ranch or bleu cheese. 11.00

SHABANG-SHABANG SHRIMP
 Sweet & spicy shrimp, lightly flash-fried. 12.00

TRY OUR DIP OF THE WEEK!

Ask your server for today's special dip. Served with fresh vegetables and pita or tortilla chips. 12.00

ARTICHOKE FRENCH
 Artichoke hearts in a tomato, sherry & butter sauce. 11.00

HUMMUS PLATE
 Fresh hummus, chickpeas, and pita or tortilla chips. 12.00

LOADED PUB TOTS
 Tater tots with cheddar cheese, bacon & scallions with cheddar or hot sauce. 11.00

LOADED NACHOS
 Four cups of Queso Pasa, chicken or beef, cheddar cheese, jalapeno, tomatoes, jalapeno peppers, & scallions, served with four cream & salsa. 12.00

QUESADILLAS
 One flour tortilla filled with pepperoni, cheddar, and melted cheddar & provolone cheese. 9.00 | Chicken 12.00 | Steak 14.00

GET AN APPETIZER THAT EVERYONE CAN SHARE!

PUB PLATTER
 Five chicken wings, two mozzarella sticks, three chicken fingers & onion rings, served with bleu cheese, marinara sauce, BBQ sauce & honey mustard. 15.00

SALADS & MORE

SALADS

CAESAR
 Romaine lettuce, croutons & parmesan cheese. 10.00

COBB
 Chopped, romaine lettuce, avocado, croutons, bleu cheese, bacon, tomatoes & egg. 11.00

HARVEST
 Mixed greens, apples, dried cranberries, candied walnuts and feta cheese. 11.00

DELI CHOPPED SALAD
 Mixed greens, ham, turkey, tomatoes, egg, cucumber, carrots & cheese. 11.00

ROASTED BEET
 Mixed greens, roasted with feta cheese, black beans, corn, roasted red peppers, red onions, almonds & croutons. 11.00

SOUTHWESTERN
 Crisp tortilla chips with mixed greens, cheddar, jack cheese, sliced tomatoes, black beans, corn, roasted red peppers & avocado. 11.00

SALAD ADD-ONS

Gilled Chicken 4.00

Gilled Shrimp 6.00

Gilled Steak 6.00

Salmon 6.00

Alu Tuna 5.00

EGG DISHES

QUICHE
 Served special changes weekly. Served with a side salad. 11.00

ITALIAN SAUSAGE FRITATA
 Classic Italian egg dish with potatoes, peppers & onions. 12.00

VEGGIE FRITATA
 With potatoes, Swiss cheese, spinach, tomatoes, peppers & onions. 12.00

SOUPS

French Onion

Chili

Soup of the Day
 (Ask your server about today's soup)
 Cupo 4.00 | Bowl 6.00

DELUXE SEWN MENUS

Deluxe Sewn menu covers offer a refined, cost-effective solution with over 30,000 possible design combinations. Multiple formats, colors, bindings, and finishes provide the flexibility to create a presentation tailored to your brand.

STEP ONE: CHOOSE YOUR CONFIGURATION & SIZE

Size is based on paper insert size. | Minimum: 24 pieces | Handcrafted in the USA



2 View Pocket
Code: TES



4 View Booklet
Code: TED



6 View Foldout
Code: TET

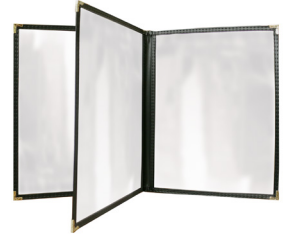

6 View Booklet
Code: TETB



8 View Booklet
Code: TEDD



10 View Booklet
Code: TE-10V

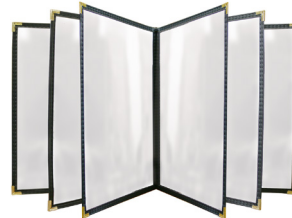

12 View Booklet
Code: TE-12V

AVAILABLE SIZES

4.25" x 11"
4.25" x 14"
5.5" x 8.5"
8.5" x 11"
8.5" x 14"
Custom

For TES & TED Only
11" x 17"

HALF PANEL DELUXE SEWN COVERS



6 View Foldout
Code: TEDQ

2 page booklet with half panel.



8 View Foldout
Code: TETQ

3 page foldout with half panel.



8 View Booklet
Code: TETBQ

3 page booklet with half panel.

HALF PANEL AVAILABLE SIZES

5.5" x 8.5"
8.5" x 11"
8.5" x 14"
Custom

STEP TWO: CHOOSE YOUR BINDING COLOR

LEATHERETTE - VINYL

Code: DS

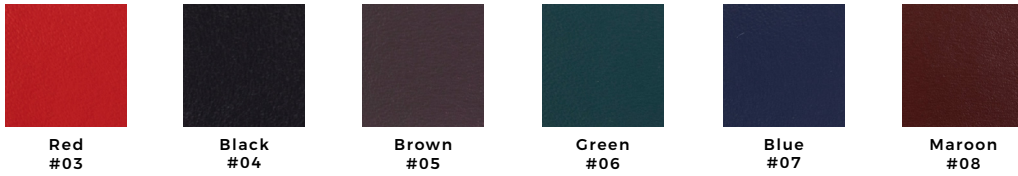

NYLON - RIBBED CLOTH

Code: DSN

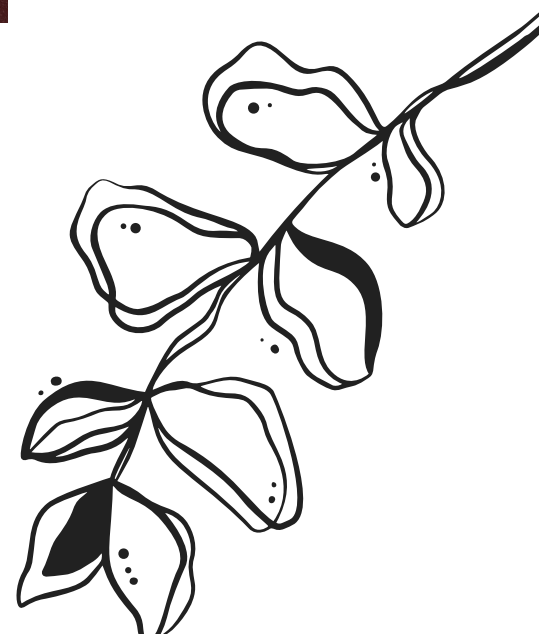

THREAD COLOR OPTIONS

Matching thread is standard, custom thread colors available with upcharge.

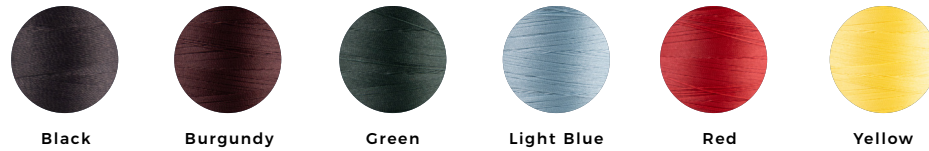

STEP THREE: CHOOSE YOUR CORNER

DECORATIVE CORNERS



SMOOTH CORNERS



STEP FOUR: CHOOSE YOUR FINISH



HOW-TO-ORDER DELUXE SEWN

All of our covers come with a clear gloss finish. Add MF between the part number and corner code if you'd like matte finish.

CONFIGURATION | INSERT SIZE | BINDING COLOR # | CORNER
EXAMPLE: TES - 8.5 x 11 - DS #03 - MF - CRN B



ADD-A-PAGE

Add-A-Pages expand your Deluxe Sewn menu cover by adding an extra panel with two additional viewing sides. Each unit includes a tabbed insert designed to fit your existing menu cover. Simply slide the tab into one of the interior pockets to instantly add more space for specials, drinks, or seasonal items. Add-A-Pages are available in both all-clear heat-sealed and sewn configurations.

Made in the USA.

HOW-TO-ORDER AN ADD-A-PAGE
ADD-A-PAGE INSERT SIZE | CLEAR TAB SIZE

MENU INSERT POCKET

VINYL TAB

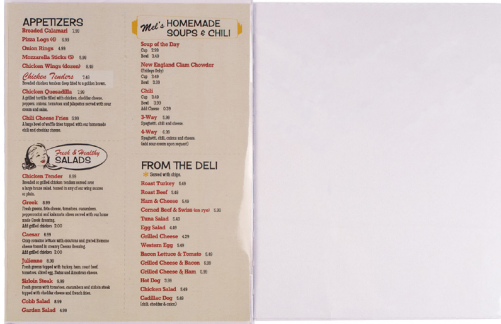

MENU INSERT POCKET

VINYL TAB



HEAT-SEALED ADD-A-PAGE

Code: **AAP** | Minimum: 3 Packs (24 Units Per Pack)

INSERT SIZE	TAB SIZE
4.25" x 11"	8.5" x 11"
4.25" x 11"	8.5" x 14"
4.25" x 14"	8.5" x 14"
8.5" x 11"	8.5" x 11"
8.5" x 11"	8.5" x 14"
8.5" x 14"	8.5" x 14"

Menu Stiffeners Available
See pg. 62

SEWN ADD-A-PAGE

Code: **SEWNAAP** | 24 Pieces

INSERT SIZE	TAB SIZE
4.25" x 11"	4.25" x 11"
4.25" x 11"	4.25" x 14"
4.25" x 11"	8.5" x 11"
4.25" x 11"	8.5" x 14"
4.25" x 14"	4.25" x 14"
4.25" x 14"	8.5" x 14"
5.5" x 8.5"	5.5" x 8.5"
5.5" x 8.5"	8.5" x 11"
5.5" x 8.5"	8.5" x 14"
8.5" x 11"	8.5" x 11"
8.5" x 11"	8.5" x 14"
8.5" x 14"	8.5" x 14"

WOOD MENUS & SIGNAGE

Our menu boards and signage make it easy to showcase your brand. From table tents to street talkers, we offer a wide range of items to reach your clientele effectively.



SAXTON & STUMP
LAWYERS AND CONSULTANTS

WOOD MENU BOARDS

Rich, authentic wooden menu board options to add depth and texture to any establishment. Choice of 2 black bands, screwpost design, or a clip to hold your menu insert in place.

Minimum: 25 pieces | Handcrafted in the USA

Available Sizes: 4.25" x 11", 4.25" x 14", 5.5" x 8.5", 8.5" x 11", 8.5" x 14"

COLOR SWATCHES



Ash

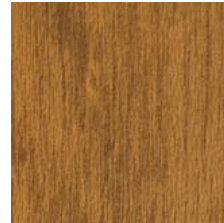

Cherry



Coffee

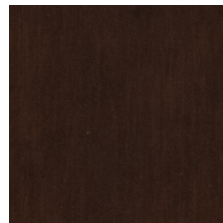

Mahogany



Maple

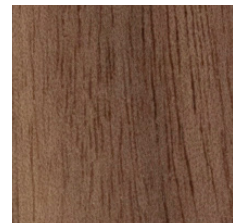

Walnut



FREE Logo Customization Options:
see pg. 65 for more info



LASER ENGRAVING



WOOD MENU BOARD

Code: WOODMENUBOARD



WOOD CLIPBOARD

⚠️ Code: WOODCLIPBOARD

Silver clip is standard, black or antique clip options are available.



BUTLER MENU BOARD

Code: BUTLER

Displays up to 4 Pages



TWO-SIDED TABLE TENT

⚠ Code: TENT

Minimum: 12 pieces

Basic, black, hardback Two-Sided Table Tent produced standard with corner tabs. Ribbon strip for collapsible for flat storage. Clear vinyl protective sheets included.

AVAILABLE SIZES

4" x 6", 5" x 7"

Custom sizes and materials available upon request with 25 piece minimum.



THREE-SIDED TABLE TENT

⚠ Code: TENT 3-SIDED

Minimum: 12 pieces

Basic, black, hardback Three-Sided Table Tent produced standard with corner tabs. Magnetic strip for collapsible, flat storage. Clear vinyl protective sheets included.

AVAILABLE SIZES

4" x 6", 4" x 8", 5" x 7"



ROLL STAND PACK

⚠ Code: ROLLSTANDPACK

Minimum: 12 pieces

A durable, 9" acrylic graphite roll stand base with 6 clear double-sided vinyl pockets to display 4.5" x 6.5" printed inserts. Roll stands and pockets also sold separately.



STREET TALKER

⚠ Code: TALKERSTREET

Minimum: 1 piece | Handcrafted in the USA

Heavy-duty wood A-Frame 22" x 41" street display with two detachable 18" x 28" chalkboards. Folds flat for storage. Full color print and blank chalkboard options available. Comes with white chalk marker.

CHECK PRESENTERS & SERVER ACCESSORIES

Add the finishing touch to your tabletop with customizable check presenters and server accessories. Our wide variety of materials and configurations are designed to be both eye-catching and functional.





**COUNTRY BOARD
CHECK PRESENTER**

⚠ Code: COUNTRYBOARD-CHECK
Minimum: 12 pieces | Made in the USA

Handcrafted in the USA 4.5" X 9" clipboard made from 3/8" solid oak with silver clip and rounded corners and edges. Black or antique clip available upon request.



**DOUBLE PANEL LED BACKLIT
CHECK PRESENTER**

⚠ Code: LED-CHECK

Minimum: 25 pieces (Blank or with Custom Logo)

Double panel, 5.5" x 10.75" bright LED light-up check presenter made with smooth, black vinyl material and hardboard backing. Includes a charging cable.



**PADDED SINGLE PANEL
CHECK PRESENTER**

Code: 1000P
Minimum: 1 Dozen (With "Thank You")

Single panel, 5" x 9" padded board check presenter made of smooth, black vinyl. Includes a small lower pocket and large upper pocket for versatile storage.



COLOR SWATCHES

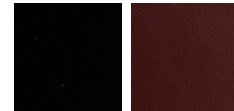

Black Wine

**PADDED DOUBLE PANEL
CHECK PRESENTER**

Code: 5000P
Minimum: 1 Dozen (Blank or with gold "Thank You")
25 pieces (With Custom Logo)

Double panel, 5" x 9" padded board check presenter made of smooth vinyl. The interior comes with 2 rounded pockets and a credit card sleeve.



**HARDBACK SINGLE PANEL
CHECK PRESENTER**

Code: 1000H
Minimum: 12 pieces (With "Thank You")
25 pieces (With Custom Logo) | Made in the USA

Single panel, 5" x 9" hardboard check presenter made with black Oakmont. Includes a 2" strip pocket at bottom with "Thank You" foil printed in metallic gold.

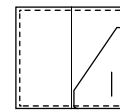

COLOR SWATCHES

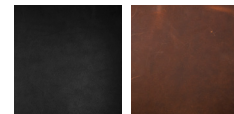

Black Brown

**GENUINE LEATHER
MINI CHECK PRESENTER**

Code: GENUINE-CHECK-MINI
Minimum: 12 pieces (Blank or with "Thank You")
25 pieces (With Custom Logo) | Made in the USA

Folding 4" x 7.5" pocket-sized design. This unpadded check presenter comes standard with a black or brown interior, and a right corner pocket with a credit card slit.

Check Presenters below are available in most materials (See Material Chart on Page 10)



Example shown:
Rattan in Desert
Black Foil Logo
*More colors &
materials available*

HARDBACK SINGLE PANEL CHECK PRESENTER

Code: 1000H

Minimum: 25 pieces | Made in the USA

Single panel, 5" x 9" hardboard check presenter with a black 2" strip pocket at bottom.

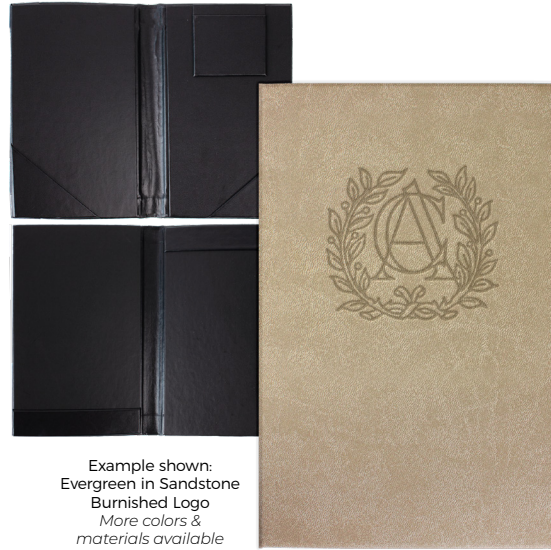

Example shown:
Evergreen in Sandstone
Burnished Logo
*More colors &
materials available*

HARDBACK DOUBLE PANEL CHECK PRESENTER

Code: 5000H-CRCC (Card Holder) or 5000H-ST (Strips)

Minimum: 25 pieces | Made in the USA

Hardback 5" x 9" double panel check presenter, interior options available are strips or diagonal corners with a credit card holder on the top right.



Example shown:
Harley in Brown
White Foil Logo
*More colors &
materials available*

DOUBLE PANEL LED CHECK PRESENTER

⚠️ Code: LED-CHECK

Minimum: 25 pieces | Made in the USA

Double panel, hardboard, 5.5" x 10.75" bright LED light-up check presenter. Includes a charging cable.



Example shown:
Genuine Leather in Brown
Burnished Logo
More colors available

GENUINE LEATHER CHECK PRESENTER

Code: GENUINE-CHECK or GENUINE-CHECK-MINI

Minimum: 25 pieces | Made in the USA

Folding 5" x 8.5" or 4" x 7.5" pocket-sized design. This unpadded check presenter comes with a right corner pocket with a credit card holder slit.



DELUXE WAITSTAFF PAD HOLDER

⚠ Code: WPHDX | Made in the USA | Size: 5.5" x 9"
 Minimum: 1 Dozen (Blank) | 25 pieces (With Custom Logo)
 Includes two rounded pockets and a pen loop.

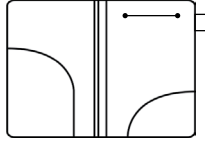

DELUXE WAITSTAFF PAD HOLDER WITH CLIP

⚠ Code: WPHDX-CLIP | Made in the USA | Size: 5.5" x 9"
 Minimum: 1 Dozen (Blank) | 25 pieces (With Custom Logo)
 Includes one large left pocket, one rounded pocket, a silver clip, and a pen loop.

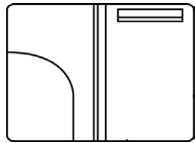

GENUINE LEATHER SERVER PAD HOLDER

Code: GENUINE-SPH | Made in the USA | Size: 5.5" x 9.25"
 Minimum: 25 pieces (Blank or With Custom Logo)
 Includes one full-height left pocket and one smaller right pocket.

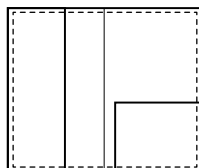

PLACEMATS, TABLEMATS, & COASTERS

From bar to dining room, our wide variety of material bound and vinyl placemats, tablemats, and coasters are sure to refresh your tabletop presentation. Many shape, size, and color options are available to suit any space.



PLACEMATS & TABLEMATS

⚠ Code: **PLACEMATDX(OCT*)** OR **TABLEMATDX(OCT*)** | Minimum: 25 pieces
Include "OCT" to indicate octagon shape, omit it for rectangular shape.

CHOOSE A CONFIGURATION



Rectangle



Octagon

CHOOSE YOUR SIZE

15" x 11"
15" x 13"
16" x 12"
17" x 11"
17" x 13"
Custom

CHOOSE YOUR STYLE

⚠ **PLACEMAT**

Flexible placemats come with stitched edges, and black non-skid backing.

TABLEMAT

Tablemats come with rigid hardboard, stitched edges, and black non-skid backing.

COASTERS

⚠ CODE: **COASTER** | Minimum: 50 pieces

CONFIGURATION

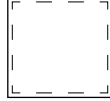

Square

SIZE

4" x 4"
Custom

STYLE

Material bound coasters come with rigid hardboard, stitched edges, and black non-skid backing.

CHOOSE YOUR MATERIAL

See pg. 10 for more info | Available materials vary by style

						
Harley pg. 14	Oakmont pg. 15	Tuxedo Leather pg. 16	Tamarac pg. 17	Chesterfield* pg. 19	Rattan* pg. 21	Rio pg. 22
						
Milan pg. 23	Vienna pg. 24	Evergreen pg. 27	Sherwood pg. 28	Vino pg. 29	Iridescent* pg. 31	

*No customization options available.

Recommended Customization Options:

See pg. 65 for more info | Available options vary by material



BURNISHING



BLIND DEBOSS

These products are designed for indoor use only. Do not submerge in water. Hand wash only.



COLOR SWATCHES



Black

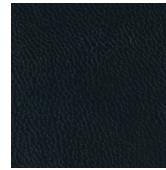

Blue



Brown



Green

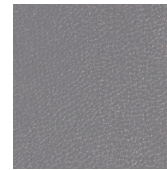

Silver



Wine

VINYL PLACEMATS & COASTERS

Decorate your tables in style. Our classic vinyl placemats and coasters are made from soft expanded vinyl reinforced with heat-sealed edges.

⚠ Placemat Minimum: 25 pieces

⚠ Coaster Minimum (No Print): 50 pieces

Coaster Minimum (Print): 100 pieces with additional logo charge

Handcrafted in the USA

Logo Customization Options:
see Appendix I for more info



BLIND DEBOSS



RECTANGLE PLACEMAT

Code: **PLACEMATRECT**

Sizes Available:

16" x 12"



OCTAGON PLACEMAT

Code: **PLACEMATOCT**

Sizes Available:

16" x 11.375", 17" x 13"



OVAL PLACEMAT

Code: **PLACEMATOVAL**

Sizes Available:

17" x 13"



ROUND PLACEMAT

Code: **PLACEMATROUND**

Sizes Available:

13", 15"



COASTER

Code: **VINYLCOASTER**

Sizes Available:

3.75"

These products are designed for indoor use only. Hand wash only.



Vinyl woven placemats are available in a variety of colors and textures. Great for enhancing your tabletop experience while protecting surfaces against most spills, scratches and stains. The heat-sealed edges prevent fraying and allow for a long-lasting, eco-friendly alternative to disposable placemats.

⚠ Minimum: 2 Dozen | Size: 16" x 12"

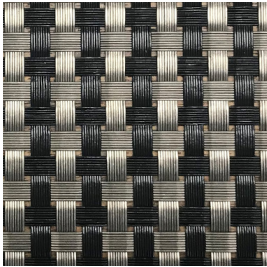

Code: **GA-2000**
Black with Pewter

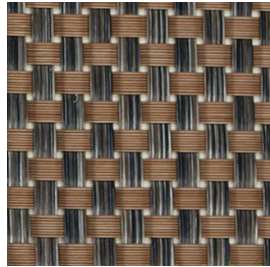

Code: **GA-2002**
Bronze with Brown

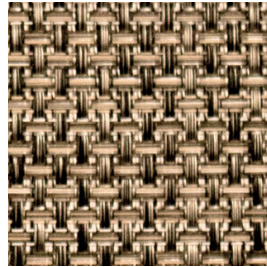

Code: **GA-2015**
Sandstone

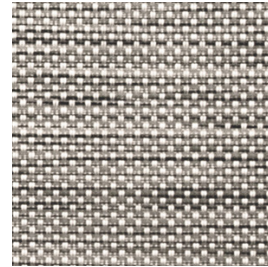

Code: **GA-2016**
Smokey Quartz

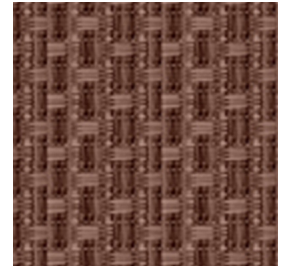

Code: **GA-4003**
Brown

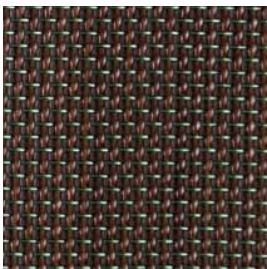

Code: **GA-5002**
Green with Brown

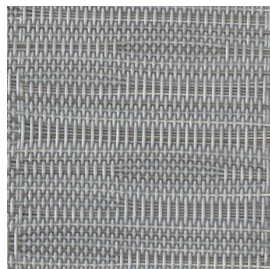

Code: **GA-7001**
Grey

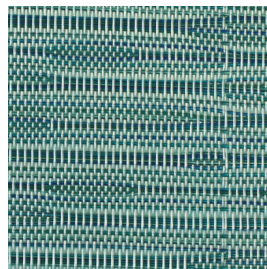

Code: **GA-7002**
Aqua

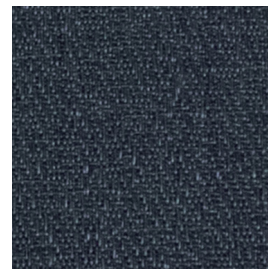

Code: **GA-8001**
Twilight

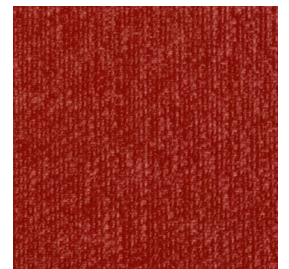

Code: **GA-8003**
Ruby

These products are designed for indoor and outdoor use. Hand wash only.



CHIP BOARD STIFFENER

Code: CHIP | Minimum: Pack of 50

Rigid hardboard menu stiffener best suited for All Clear Vinyl and Deluxe Sewn menu covers.

AVAILABLE SIZES

4.25" x 11", 4.25" x 14", 5.5" x 8.5",
8.5" x 11", 8.5" x 14", 11" x 17"



TAG PAPER STIFFENER

Code: TAG | Minimum: Pack of 50

Semi-flexible menu stiffener best suited for All Clear Vinyl and Deluxe Sewn menu covers.

AVAILABLE SIZES

4.25" x 11", 4.25" x 14", 5.5" x 8.5",
8.5" x 11", 8.5" x 14", 11" x 17"



PAGE PROTECTORS

Code: PAGE PRO | Minimum: Pack of 50

Three hole punched clear vinyl page protectors designed for the Pinehurst Binder, Augusta Screwpost, and Chicago Menu Board configurations.

AVAILABLE SIZES

4.25" x 11", 4.25" x 14", 5.5" x 8.5",
8.5" x 11", 8.5" x 14"



SILICONE BANDS

⚠ Code: BANDS | Minimum: Pack of 50

Black silicone bands designed to secure inserts on menu boards.

AVAILABLE SIZES

5.5", 8.5"

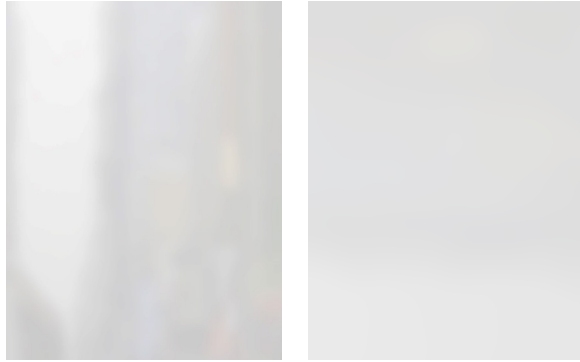

VINYL SHEET PROTECTORS

Code: CLEAR VINYL | Minimum: Pack of 50

Clear vinyl overlays to give additional protection to table tents and card interior menu cover inserts. Matte and glossy options available.

AVAILABLE SIZES

- 4" x 6"
- 4" x 8"
- 5" x 7"
- 4.25" x 11"
- 4.25" x 14"
- 5.5" x 8.5"
- 8.5" x 11"
- 8.5" x 14"
- 11" x 17"



ELASTIC BANDS

⚠ Code: ELASTIC | Minimum: Pack of 100

Decorative elastic bands used to hold folded paper inserts. Designed for the Augusta menu cover configurations.

AVAILABLE SIZES & STYLES

ELASTIC WITH TASSEL

Available Colors: Black, Gold, Silver
Available Sizes: 8", 10", 12", 13", 15"

ELASTIC WITH BALL

Available Colors: Black, Gold, Silver
Available Sizes: 8", 10", 12", 13", 15"

ELASTIC WITH BARB (FOR EYELETS)

Available Colors: Black, Gold, Silver
Available Sizes: 6", 9", 12", 15"



PERSONALIZATION

Make your menu presentation one-of-a-kind with our wide variety of artwork application options, durability upgrades, and customizable detailing.

Personalize your menu cover with your logo, colors, and materials of choice to create a polished presentation that complements your restaurant's atmosphere.

At Risch, we are dedicated to bringing your unique vision to life.



CUSTOMIZATION OPTIONS

We offer a vast selection of imprint options to help you create a custom look for your menu covers. While nearly all our products can have customized logos and prints, it's important to note that not every imprint option is viable on every product. To ensure the best results, all stamping and imprint options are clearly noted by product/collection.



COLOR FOIL STAMP

Create a striking impression of your logo with our color foil stamping service. We use a metal die to apply your logo onto the product with a wide range of foil color options to choose from (see all options on pg 66). This option is available for most products in our material bound collections.



BLIND DEBOSS

For a sophisticated and subtle look, choose our blind debossing service. We use a metal die to recess your logo onto the product without the application of foil.

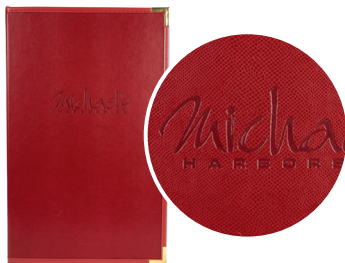

BURNISH

Our burnishing service produces a branded, darkened, and recessed effect of your logo onto the product, without the use of foil. We use a metal die to create a lasting impression that adds a touch of elegance to your menu covers.



EMBOSSING

Our Patina Copper products can be customized with our embossing service. We use an inverted copper metal die to create a raised logo without the use of foil, giving your menu cover a distinct and unique look.



LASER ENGRAVING

Our wood products can be customized with our laser engraving service to engrave your logo directly into the wood. This option provides exceptional detail and is the only available option for our authentic wood products.



FULL COLOR PRINT

We offer full color UV logo printing for most products in our material bound collections. This option is ideal for logos with many complex details and colors that may not be suitable for stamping.

COLOR FOIL STAMP OPTIONS

This process involves the fabrication of a metal die that imprints your logo into the product with the application of foil. We have a wide variety of foils available in nearly every color.

METALLIC

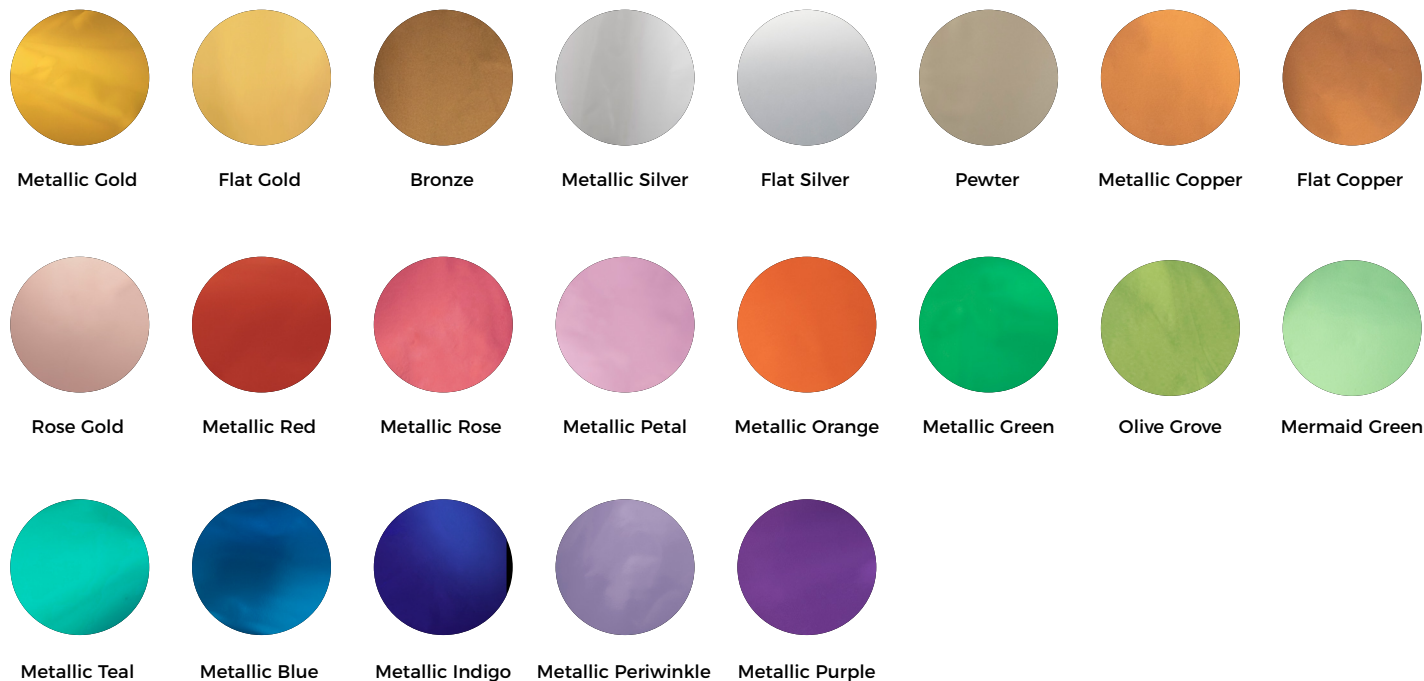

MATTE & GLOSS





MONTICELLO WINDOW INLAY

A unique die-cut shape with an inlay of your choice in the cut-out area. Choose from a full-color photo print, die-stamped cover material, laser-engraved wood, or patina copper. Available for most products in our material bound collections, this option adds an eye-catching feature to your custom menu covers.



PHOTO WINDOW
Code: **Mon**

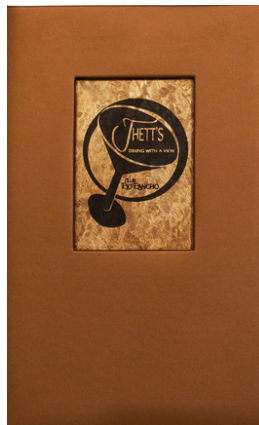

MATERIAL STAMP
Code: **Mon-De**



PATINA COPPER METAL
Code: **Mon-Patina**

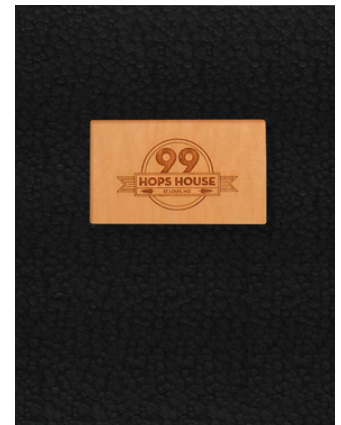

LASER ENGRAVED WOOD
Code: **Mon-Wood**

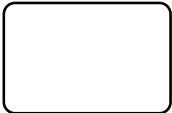
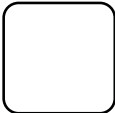
WINDOW SIZE OPTIONS	
RECTANGULAR WINDOW	SQUARE WINDOW
 <ul style="list-style-type: none"> 1.5" x 2" 2" x 3.5" 3" x 5" 4" x 6" 	 <ul style="list-style-type: none"> 3.25" x 3.5" 3.5" x 3.5" 5" x 5"

MATERIAL BOUND MENU UPGRADES & DELUXE OPTIONS

Enhance durability, functionality, and presentation with premium upgrade options. Availability of upgrades varies by configuration and material.



METAL CORNERS

Reinforce high-wear corners for a premium look and longer service life, ideal for busy restaurants. Metal corners are a popular premium upgrade to casemade covers.

CORNER STYLE OPTIONS



Gold
Corner E



Silver
Corner F



Black
Corner K

STITCHED EDGES

Add a stitched perimeter for a refined, handcrafted finish and improved edge durability. Create a premium tailored look with your custom thread color of choice.

THREAD COLOR OPTIONS



Black



Burgundy



Green



Light Blue



Red



Yellow

MAKE IT A “DELUXE”

Finish edges with a sewn leatherette binding trim and decorative metal corners for an extra-durable, clean, upscale appearance.

BINDING TRIM COLOR OPTIONS



Red
#03

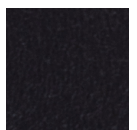

Black
#04

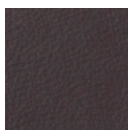

Brown
#05



Green
#06

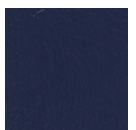

Blue
#07



Maroon
#08

Can't Find The Perfect Product?

We're experts in customization and tailoring products to our customers' specific needs. Call us at 800.660.3335 or email us at info@hrisch.com.

INTERIOR & FUNCTIONAL UPGRADES



STANDARD ALBUM-STYLE CORNERS
Paper inserts slip behind corner cards at each corner. A classic, traditional option with clean presentation, best suited to lighter-use environments.



UPGRADE STRIP CARDS
Adds a 1" retention strip at the top and bottom to better secure inserts. This upgrade improves insert stability, allows for easier insert changes, and creates a cleaner, more refined interior appearance.



BINDER POCKET UPGRADE

Add a black interior card with a 4" bottom pocket, perfect for in-room directories, wine lists, or supplemental inserts. Creates an organized experience for multi-section content.

Compatible with 3-Ring Binder, Chicago Menu Board, and Augusta Screwpost configurations.



COMMERCIAL GRADE 3-RING PAGE PROTECTORS

Code: **PAGEPRO** (Standard)
Code: **PAGEPRO-CMBFFWOOD** (Wood Chicago Menu Boards)
Code: **PAGEPRO-FH** (Augusta Screw Post)

Minimum: Pack of 100

Add extra protection, spill resistance, and durability to your binders and menu boards with our heavy-duty clear vinyl page protectors.

Compatible with 3-Ring Binders, Screw Post Binders, Chicago Menu Boards, and Augusta Eyelets. Available in all standard paper insert sizes, custom sizes available upon request.



Code: **CLEAR VINYL**



Code: **MATTE VINYL**

VINYL SHEET PROTECTOR INSERTS

Code: **CLEAR VINYL** or **MATTE VINYL**

Minimum: Pack of 100

Add protection and durability with our vinyl sheet protector inserts. These overlays fit snugly on top of your paper menu inserts in our album-style carded menu corners. Both the clear and glare-resistant matte finish options are easy to clean and stain resistant.

Available in all standard paper insert sizes. Compatible with carded menu covers.

GENERAL INFO

ORDERS

Orders may be placed by email at info@hrisch.com.

TERMS

Credit cards, certified checks, company checks, and ACH transfers are accepted.

SHIPPING

Shipping and handling charges are FOB Origin, Rochester, NY. Title and risk of loss transfer to the customer upon carrier pickup. Risch is not responsible for delays, loss, or damage in transit; however, we are happy to assist with carrier claims when needed. Please verify that all shipping information is accurate. Corrections or changes may be subject to an administrative fee.

LEAD TIMES

Lead times may vary by season and demand. Updated lead times are available through customer service.

RUSH ORDERS

Expedited lead times may be available and are subject to a rush order charge.

SAMPLES

Physical samples and digital renderings are available upon request. Most of our samples are available at no charge. We do our best to send the item closest to your request, however samples are not always available in the exact configuration requested.

Samples may be subject to freight.

CUSTOM SAMPLES

Customized samples available upon request and are subject to additional charges.

SWATCHES

Material swatches are available for color verification.

PROOFS

Up to three digital renderings with your logo are also available at no charge.

RETURNS

A Return Authorization (RA) number is mandatory for all returns and must be requested within 10 business days of customer's receipt of the product. Product must be returned within 10 business days of RA being issued. RA numbers must be clearly marked on the outside of the package being returned.

TERMS

All returns must be in new condition (not used in any way).

RESTOCK FEE

Returnable products may be subject to a re-stocking fee.

CUSTOM PRODUCTS

Customized and non-stock items are non-returnable. If your product is deemed defective or if you have received incorrect merchandise, Risch, at its discretion, will either replace the product or refund your payment in full.

LOGOS & CUSTOM DIES

At Risch, you can customize your products with your establishment's logo. We offer custom dies free of charge. One free logo imprint in one location only.

ARTWORK RE-WORK

If artwork requires additional clean up or correction, it may be subject to a re-work charge.

TYPESSETTING

If you don't have a logo, we offer a free typesetting form that allows you to choose a font style, font size, as well as layout and positioning.

MULTI-COLOR & MULTI-LOCATION LOGOS

All multiple colored logos must be approved by Risch. There must be at least an 1/8" separation between colors for foil stamping. Multiple color logos are subject to a fee.



Talk to us about creating your custom product today!



Risch Inc.

44 Saginaw Drive
Rochester, NY 14623

800.660.3335

info@hrisch.com

2026

CONNECT WITH US

@rischmenucovers | #rischmenucovers



VISIT US ONLINE
at hrisch.com or scan
the QR code.

