

PRODUCT CATALOG VERSION 6.1



# WE ARE **MORE** THAN JUST CHAIRS!

**just**

*/jəst/*

adjective

"... according to what is morally right and fair"

Yes, our chairs are where we are **just**. This ensures you get the best chairs and the best service.

But, we supply all types of commercial furniture. And, we also deliver that same **just** commitment on every product, for all your front-of-house projects.

We are

 **Just Chairs**  
and More!

## OUR LEAD TIMES FOR TYPICAL CONFIGURATIONS:

JCM products are available via commercial restaurant equipment dealers, architects, designers and contractors nationwide.

**5-10**  
work days

QuickShip<sup>†</sup>  
minimal assembly  
products

**4-6**  
weeks

Standard  
stock assembly/build and  
configuration required

**12-18**  
weeks

Built to Order\*  
factory custom built  
and non-stocked

<sup>†</sup> Large quantities may change lead times.

\* Limited - Check with factory. MOQ may apply.

# JUSTCHAIR 2022

01	CITYSTYLE SEATING	05
02	WOOD SEATING	13
03	UPHOLSTERED SEATING	27
04	METAL SEATING	38
05	BOOTHS & BANQUETTES	51
06	WOOD FRAME BOOTHS	61
08	CONTOUR SEATING	67
06	TABLE TOPS & BASES	73
09	OUTDOOR SEATING & TABLES	87
10	TRASH RECEPTACLES	93
11	PLANNING & OPTIONS	97

## SEAT DEFINITIONS

-FSC	Fixed seat Cushion	-POS	Pullover Seat
-FRL	Foot Rail Guard	-PBS	Padded Box Seat
-PS	Padded Seat	-PBSW	Padded Box seat w/ Welt Cord
-PSW	Padded Seat w/ Welt Cord	-SS	Solid Seat
-PIS	Padded Inset Seat	-SPS	Standard Padded Seat
		-VS	Veneer Seat

## BACK DEFINITIONS

-PIB	Padded Inside / Inset back
-DN	Decorative Nails Added
-POB	Pullover back
-FBC	Fixed back Cushion



## JUSTCHAIR QUICKSHIP

All products which are NOT built-to order, can Quick Ship.

Just select a stocked seat item (black vinyl or wood).

# ABOUT

## JCM 1-YEAR / 5-YEAR / 12-YEAR STRUCTURAL LIMITED WARRANTY

Just Chairs and More! warrants all JCM products to be free of manufacturing defects in material and workmanship as follows:

- Steel and aluminum banquet chairs:  
12 Years from date of purchase
- German Beech Wood Seating:  
5 Years from date of purchase
- Welded Steel Furniture:  
5 Years from date of purchase
- Powder Coated Stacking Furniture:  
5 Years from date of purchase
- TBX Table Bases:  
5 Years from date of purchase
- Millwork, Tops & Booths:  
1 Year from date of purchase
- Outdoor & Chrome Furniture:  
1 Year from date of purchase

From the original date of purchase, by the original purchaser or JCM dealer unless otherwise noted.

JCM's warranty responsibility is limited to the cost of replacement or repair (at JCM's discretion) of the JCM products. FOB Factory.

## WOOD STANDARDS

### REGULATIONS & EXCEPTIONS

U.S. Commercial Standards/Regulations require us to advise the customer that a wood product may experience some degree of warpage and thickness variation. We do not warranty warpage.

Customer assumes responsibility for normal wear and tear.

Products sold as 'closeouts', 'as-is' and 'used' have no warranties.

JCM is not responsible for warranty claims reported after 30 days from first recognition of the issue by the end-user.

# GENERAL INFORMATION

## SUPERIOR PACKAGING

### NO ONE WRAPS LIKE WE DO

Every JCM product is fully wrapped and protected, exceeding industry standards. Every chair leg is covered. Every glide is protected.

Our goal is to ensure that the quality that leaves our dock, reaches the door, perfect & undamaged.



## WHERE TO BUY

### YOUR LOCAL SUPPORT NETWORK

JCM sells all products via dealers, designers, contractors and consultants. This ensures that every product is sold with expertise and local support, before and after the sale.

We are happy to assist anyone with layout, design, and planning.

Our nationwide sales network can also assist or provide referrals to local consultants.

Our professional sales network includes:

- Regional Manufacturer Representatives
- Restaurant Equipment Dealers
- Commercial Furniture Distributors
- Interior Design Firms and Architectural Firms
- General Contractors
- Professional Consultants





# CITYSTYLE SEATING

Mixed Mode - Metal, Poly, Wood



01



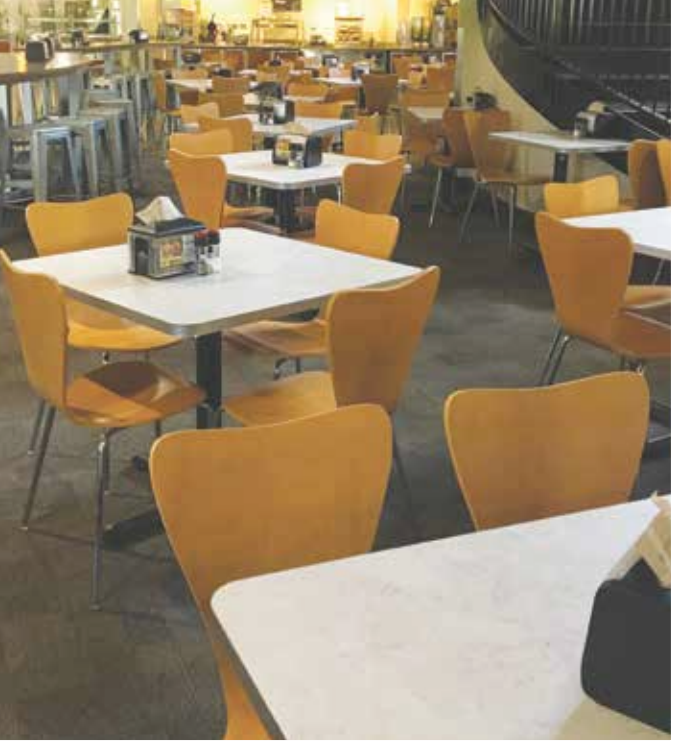

# M633

## CITYSTYLE - WOOD INSERT

Cut wood insert veneer backs on a powder coated metal frame. Solid wood, veneer and upholstered seat choices.

M63318  
01 Back  
w/ Solid seat



M63330  
04 Back  
w/ Padded seat



### SEAT

Padded seat, solid wood seat or veneer seat

### BACK

01 Style: Small circle with three lines cut  
04 Style: Large hole cut

### FRAME

Textured black (TB16), powder coated, welded steel frame with rust inhibitor. Black nylon glides

### QUICK SHIP CONFIGURATION

Seat - Vinyl



Seat - Solid Wood or Veneer

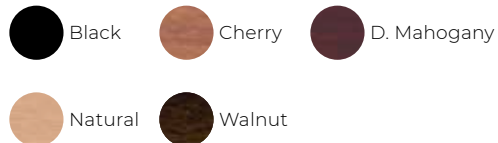

Back - 01 or 04







Frame



### CUSTOM OPTIONS

Factory BTO custom colors available, 100 pc. MOQ  
Local customization available, no MOQ  
Upholstery: See Planning & Options (page 97)

### DIMENSIONS AND WEIGHTS

					
Chair (18)	32"	18"	17.5"	17"	18 lbs
Barstool (30)	42"	30"	17.5"	17"	22 lbs





# M668

## CITYSTYLE - MIXED SCHOOLHOUSE

Black welded steel seating with solid oak rustic cut seat and back.

M66818

Honey Oak Finish  
Square Steel Frame



M66830

Walnut Finish  
Square Steel Frame



M66830X

Walnut Finish  
Round Steel Frame



The only wood seat available for the 30X is Walnut on Oak

### SEAT & BACK

Solid oak, standard. Padded seats also available

### FRAME

Textured black (TB16), powder coated, welded steel frame with rust inhibitor. Black nylon glides

### QUICK SHIP CONFIGURATION

Seat & Back - Solid Wood



Natural Oak



Natural Beech (back)



Walnut Oak

Frame



Black TB16







Copper Vein CV

### CUSTOM OPTIONS

Factory BTO custom colors available, 100 pc. MOQ  
Local customization available, no MOQ  
Upholstery: See Planning & Options (page 97)

### DIMENSIONS AND WEIGHTS

					
Chair (18)	34.5"	18"	16"	17"	19 lbs
Barstool (30)	44"	30"	16"	17"	23 lbs
Barstool (30X)	-	30"	15.5"	15.5"	12 lbs



8

Just Chairs and More! · 347.617.1317  
JustChair.com · Info@JustChair.com

# M678

## CITYSTYLE - METAL BOX FRAME

Saddle back seating with heavy duty steel brackets. Upholstered seat and back on metal frame.

M67818



M67830



### SEAT & BACK

Saddle back seating with heavy duty steel brackets. Upholstered seat and back on metal frame.

PS: 2 ½" double-thick padded upholstered seat

### FRAME

Textured black (TB16), powder coated, welded steel frame with rust inhibitor. Black nylon glides

### QUICK SHIP CONFIGURATION

Seat - Vinyl



Black

Back - Rolled Veneer



Walnut



Natural

Frame - Textured Black



Black (TB16)





### CUSTOM OPTIONS

Factory BTO custom colors available, 100 pc. MOQ

Local customization available, no MOQ

Upholstery: See Planning & Options (page 97)

### DIMENSIONS AND WEIGHTS

					
Chair (18)	30.5"	17"	17"	16"	20 lbs
Barstool (30)	43"	30"	17"	16"	25 lbs

Shown with Olympus Royal GR2 Seat



R912

# CITYSTYLE - RUSTIC WALNUT

Rustic solid beech, with straight stretchers. Rustic Walnut finish with black steel connections.

R91218



## SEAT & BACK

Seat, back, legs: Rustic cut and styled, European beech wood

## FRAME

Powder coated, welded steel brackets, tan nail-in nylon glides

## QUICK SHIP CONFIGURATION

Seat , Back, Legs

 Rustic styled walnut

Frame

 Black (TB16)





## CUSTOM OPTIONS

Factory BTO custom colors available, 100 pc. MOQ

Local customization available, no MOQ

Upholstery: See Planning & Options (page 97)

## DIMENSIONS AND WEIGHTS

					
Chair (18)	32"	18"	15.5"	15.5"	20 lbs
Barstool (30)	42"	29"	15.5"	15.5"	22 lbs

R91230





# U902

## CITYSTYLE - BUCKET

Contemporary bucket on a reinforced ash wood frame.

U90218  
White



U90230  
White



### SEAT

Double thickness, tight-cell polypropylene

### FRAME

Mortise and tenon, solid ash wood, with nail-in nylon glides

### QUICK SHIP CONFIGURATION

#### Seat







#### Frame - Ash

Natural Ash

### CUSTOM OPTIONS

Factory BTO custom colors available, 100 pc. MOQ  
Local customization available, no MOQ  
Upholstery: See Planning & Options (page 97)

### DIMENSIONS AND WEIGHTS

					
Chair (18)	35"	17.5"	18.5"	17"	14 lbs
Barstool (30)	41"	29.0"	18.5"	16"	16 lbs



# U905

## CITYSTYLE - HAIRPIN

Urban hairpin frame design. Multiple laminate and frame color options available.

U90518  
Driftwood



U90530  
Natural



U90530X  
Driftwood



U90518X  
Driftwood

### SEAT & BACK

Seat & back: Double-sided laminate plywood

### FRAME

Powder coated, welded steel frame with black, screw-in nylon glides

### QUICK SHIP CONFIGURATION

#### Seat & Back



Driftwood



Natural Ash

#### Frame



Black (TB16)



White

### STANDARD OPTIONS

PIB, PS





### CUSTOM OPTIONS

Factory BTO custom colors available, 100 pc. MOQ

Local customization available, no MOQ

Upholstery: See Planning & Options (page 97)

### DIMENSIONS AND WEIGHTS

					
Chair (18)	32"	18"	16.5"	16"	14 lbs
Barstool (30)	43"	30"	16.5"	16"	17 lbs

Shown with  
Fixed Seat  
Cushion and  
Fixed Back  
Cushion



# WOOD SEATING

Beech and Ash Wood Frame



02







W900

# RUSTIC - X-BACK STACKABLE

Country Style, Rustic Bentwood X-back. Stackable Chair.

R90018  
Stackable



R90030



## SEAT

Rustic finish, ash veneer

## FRAME

Rustic cut, solid ash, with tan nail-in nylon glides

## QUICK SHIP CONFIGURATION

Seat & Frame

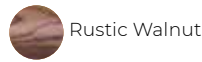

## STANDARD OPTIONS





FSC

## CUSTOM OPTIONS

BTO colors and finishes available, 50 pc. Minimum order quantity

See Planning & Options (page 97) for more information

## DIMENSIONS AND WEIGHTS

					
Chair (18)	35.0"	18.5"	18"	16.5"	10 lbs
Barstool (30)	45.5"	29.0"	18"	16.5"	14 lbs

Shown with  
Fixed Seat  
Cushion



# W116

## WOOD - LINED BACK

Flared back with horizontal slotted lines. Heavy duty steel brackets. German beech, tongue & groove hardwood construction.

W11618



W11630



### SEAT

SS: Solid European beech wood, saddle cut  
PS: 2-1/2" double-thick padded upholstered seat

### FRAME

Full joinery, factory sealed construction  
European beech wood, with tan, nail-in nylon glides

### QUICK SHIP CONFIGURATION

Seat - Solid Wood

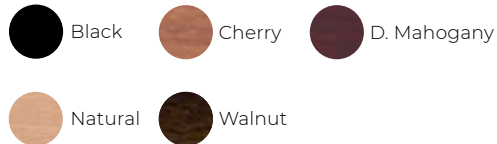

Seat - Vinyl



Frame







### STANDARD OPTIONS

DN, FRL, PIB, POS, SS

### CUSTOM OPTIONS

BTO finishes available, 50 pc. Minimum order quantity  
See Planning & Options (page 97) for more information

### DIMENSIONS AND WEIGHTS

					
Chair (18)	34"	18"	17"	17"	15 lbs
Barstool (30)	44"	30"	17"	17"	21 lbs





# W201

## WOOD - LADDER BACK

Traditional ladder back seating with heavy duty steel brackets. German beech, tongue & groove hardwood construction.

W20118



W20130



### SEAT

SS: Solid European beech wood, saddle cut  
PS: 2-1/2" double-thick padded upholstered seat

### FRAME

Full joinery, factory sealed construction  
European beech wood, with tan, nail-in nylon glides

### QUICK SHIP CONFIGURATION

Seat - Solid Wood

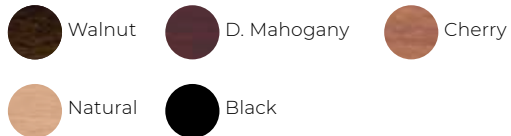

Seat - Vinyl



Frame

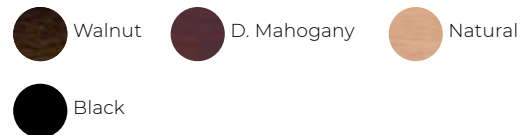





### STANDARD OPTIONS

DN, FRL, PIB, POB, POS, SS

### CUSTOM OPTIONS

BTO finishes available, 50 pc. Minimum order quantity  
See Planning & Options (page 97) for more information

### DIMENSIONS AND WEIGHTS

					
Chair (18)	34"	18"	17"	17"	16 lbs
Barstool (30)	43"	30"	17"	17"	20 lbs



# W271

## WOOD - WINDOW BACK

Window back seating with heavy duty steel brackets.  
German beech, tongue & groove hardwood construction.

W27118



W27130



Padded  
Inside Back  
Shown



### SEAT

SS: Solid European beech wood, saddle cut  
PS: 2 1/2" double-thick padded upholstered seat

### FRAME

Full joinery, factory sealed construction  
European beech wood, with tan, nail-in nylon glides

### QUICK SHIP CONFIGURATION

Seat - Solid Wood

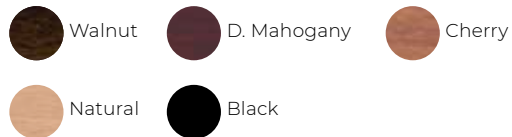

Seat - Vinyl



Frame



### STANDARD OPTIONS

DN, FRL, PIB, POS

### CUSTOM OPTIONS

BTO finishes available, 50 pc. minimum order quantity  
See Planning & Options (page 97) for more information

### DIMENSIONS AND WEIGHTS

					
Chair (18)	35"	18"	17"	17"	16 lbs
Barstool (30)	44"	30"	17"	17"	20 lbs



# W347

## WOOD - FLOATING BACK

Floating slat back seating with heavy duty steel brackets.  
German beech, tongue & groove hardwood construction.

W34718



### SEAT

SS: Solid European beech wood, saddle cut  
PS: 2-1/2" double-thick padded upholstered seat

### FRAME

Full joinery, factory sealed construction  
European beech wood, with tan, nail-in nylon glides

### QUICK SHIP CONFIGURATION

Seat - Solid Wood

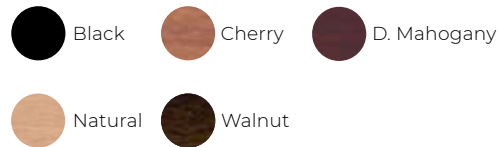

Seat - Vinyl



Frame



W34730  
Solid Seat







### STANDARD OPTIONS

DN, FRL, PIB, POS

### CUSTOM OPTIONS

BTO finishes available, 50 pc. Minimum order quantity  
See Planning & Options (page 97) for more information

### DIMENSIONS AND WEIGHTS

					
Chair (18)	34"	18"	17"	17"	16 lbs
Barstool (30)	43.5"	30"	17"	17"	20 lbs



# W364

## WOOD - SCHOOLHOUSE

Schoolhouse style, slat back seating.  
German beech, tongue & groove hardwood construction.  
100% factory finish and assembly.

W36418



W36430



W36430-SWL

Shown with Thick  
Fixed Seat & FRL-GLD



### SEAT

SS: Solid European beech wood, saddle cut

### FRAME

Full joinery, factory sealed construction  
European beech wood, with tan, nail-in nylon glides  
Also available in a swivel seat version

### QUICK SHIP CONFIGURATION

Seat & Frame



Walnut



Black





### STANDARD OPTIONS

DN, FRL, PIB, PS

### CUSTOM OPTIONS

BTO finishes available, 50 pc. Minimum order quantity  
See Planning & Options (page 97) for more information

### DIMENSIONS AND WEIGHTS

					
Chair (18)	35"	18"	18"	17"	18 lbs
Barstool (30)	44"	30"	18"	17"	24 lbs
BS-SWL (30)	45"	30"	18"	17"	32 lbs

Shown  
with Fixed  
Padded Seat

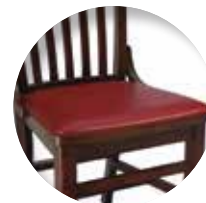

# W388

## WOOD - FLARED BACK

Flared back seating with heavy duty steel brackets.  
German beech, tongue & groove hardwood construction.

W38818



W38830



Shown with  
Optional  
FRL-SIL

### SEAT

SS: Solid European beech wood, saddle cut  
PS: 2 ½" double-thick padded upholstered seat

### FRAME

Full joinery, factory sealed construction  
European beech wood, with tan, nail-in nylon glides

### QUICK SHIP CONFIGURATION

Seat - Solid Wood

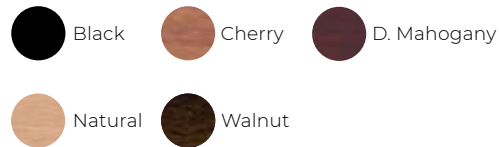

Seat - Vinyl



Frame







### STANDARD OPTIONS

DN, FRL, PIB, POS

### CUSTOM OPTIONS

BTO finishes available, 50 pc. Minimum order quantity  
See Planning & Options (page 97) for more information

### DIMENSIONS AND WEIGHTS

					
Chair (18)	34"	18"	17"	17"	16 lbs
Barstool (30)	44"	30"	17"	17"	19 lbs



21

Just Chairs and More! · 347.617.1317  
JustChair.com · Info@JustChair.com

# W707

## WOOD - NOTCHED BACK

Notched floating back seating with heavy duty steel brackets. German beech, tongue & groove hardwood construction.

W70718



W70730



Shown with optional FRL-GLD



Shown with Padded Inside Back & Decorative Nails

### SEAT

SS: Solid European beech wood, saddle cut  
PS: 2 1/2" double-thick padded upholstered seat

### FRAME

Full joinery, factory sealed construction  
European beech wood, with tan, nail-in nylon glides

### QUICK SHIP CONFIGURATION

Seat - Solid Wood

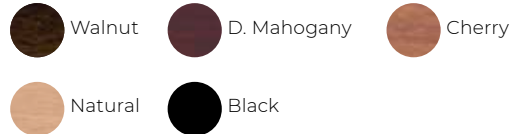

Seat - Vinyl



Frame



### STANDARD OPTIONS

DN, FRL, PIB, POS

### CUSTOM OPTIONS

BTO finishes available, 50 pc. Minimum order quantity  
See Planning & Options (page 97) for more information

### DIMENSIONS AND WEIGHTS

					
Chair (18)	35"	18"	17"	17"	16 lbs
Barstool (30)	44"	30"	17"	17"	19 lbs



22

Just Chairs and More! · 347.617.1317  
JustChair.com · Info@JustChair.com



W715

## WOOD - TAPERED FLOATING BACK

Tapered floating slat back seating with heavy duty steel brackets. German beech, tongue & groove hardwood construction.

W71518



### SEAT

1 ½" padded upholstered, contoured seat

### BACK & FRAME

Full joinery, factory sealed construction  
European beech wood, with tan, nail-in nylon glides

### QUICK SHIP CONFIGURATION

Seat - Vinyl



Black

Frame



Natural



Walnut

### CUSTOM OPTIONS

BTO finishes available, 50 pc. Minimum order quantity  
See Planning & Options (page 97) for more information

### DIMENSIONS AND WEIGHTS

					
Chair (18)	30"	18"	19"	18.5"	17 lbs



# W730



W73018

## WOOD - SADDLE BACK

Contemporary molded back on solid wood frame.

### SEAT

½" padded upholstered, contoured seat

### BACK & FRAME

Full joinery, factory sealed construction  
European beech wood, with tan, nail-in nylon glides

### QUICK SHIP CONFIGURATION

Seat - Vinyl & Frame

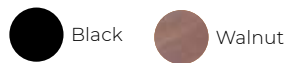

### DIMENSIONS AND WEIGHTS



# W740



W74018

## WOOD - VENEER MOLDED BACK & SEAT

Contemporary molded veneer back seat on stylized hardwood frame.

### SEAT & BACK

½" veneer molded

### FRAME

Full joinery, factory sealed construction  
European beech wood, with tan, nail-in nylon glides

### QUICK SHIP CONFIGURATION

Back & Frame



### DIMENSIONS AND WEIGHTS



W911

# WOOD - DECORATIVE LADDER BACK

Factory glued and sealed.  
German beech, tongue & groove hardwood construction.

W91118



W91118A



W91130



## SEAT

3" thick padded upholstered box seat

## FRAME

Full joinery, factory sealed construction  
European beech wood, with tan, nail-in nylon glides

*\*W-91118A Armrest 200 lb Max Capacity*

## QUICK SHIP CONFIGURATION

Seat - Vinyl



Black

Frame



Walnut





## STANDARD OPTIONS

FRL, PIB

## CUSTOM OPTIONS

BTO finishes available, 50 pc. Minimum order quantity  
See Planning & Options (page 97) for more information

## DIMENSIONS AND WEIGHTS

					
Side (18)	33.5"	19"	18"	18"	18 lbs
Arm (18A)	33.5"	19"	21.5"	18"	20 lbs
Barstool (30)	43.5"	30"	18"	18"	24 lbs



# WBSX

## WOOD - BACKLESS BARSTOOL

Factory glued and sealed.  
German beech, tongue & groove hardwood construction.



### SEAT

2" thick padded upholstered seat

### FRAME



Full joinery, factory sealed construction  
European beech wood, tan, nail-in nylon glides

### QUICK SHIP CONFIGURATION

#### Seat

 Black Vinyl

#### Frame

 Walnut  Black

### STANDARD OPTIONS

DN, FRL, POS

### CUSTOM OPTIONS

BTO finishes available, 50 pc. Minimum order quantity  
See Planning & Options (page 97) for more information

### DIMENSIONS AND WEIGHTS

W23330X



W234 (30X)	-	29.5"	15.5"	15.5"	15 lbs
W233 (30X)	-	29.5"	17"	17"	22 lbs



# UPHOLSTERED SEATING



03



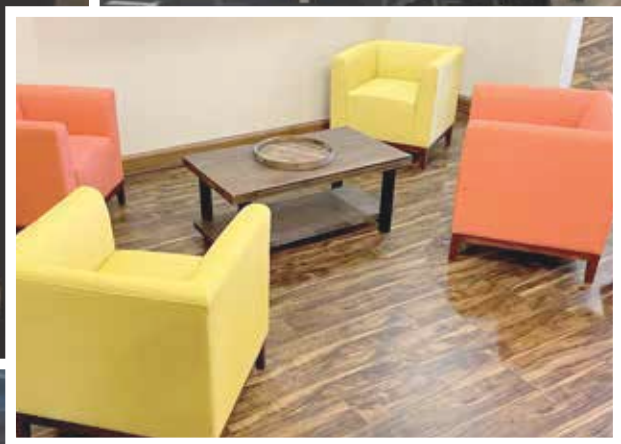



W301

# UPHOLSTERED - FLARED INSET BACK

Upholstered inset back with padded seat, with heavy duty steel brackets. German beech, tongue & groove hardwood construction.

W30118



W30130



Rear View  
of Back

## SEAT

PS: 2 ½" double-thick padded upholstered seat

## FRAME

Full joinery, factory sealed construction  
European beech wood, with tan, nail-in nylon glides

## QUICK SHIP CONFIGURATION

Inset Back & Seat - Vinyl



Black

Seat - Wood



Black



Cherry



D. Mahogany



Natural



Walnut

Frame

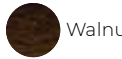

Walnut



D. Mahogany



## STANDARD OPTIONS

PS, FRL

## CUSTOM OPTIONS

BTO finishes available, 50 pc. Minimum order quantity  
See Planning & Options (page 97) for more information

## DIMENSIONS AND WEIGHTS

					
Chair (18)	35"	18"	17"	17"	17 lbs
Barstool (30)	45"	30"	17"	17"	19 lbs



# W313

## UPHOLSTERED FLARED PULLOVER BACK

Upholstered pullover back with pullover seat, with heavy duty steel brackets. German beech, tongue & groove hardwood construction.

W31318



### SEAT

Pullover seat, standard with decorative nails

### FRAME

Full joinery, factory sealed construction  
European beech wood, with tan, nail-in nylon glides

### STANDARD CONFIGURATION

#### Seat & Back

See page 110 for vinyl options

#### Frame

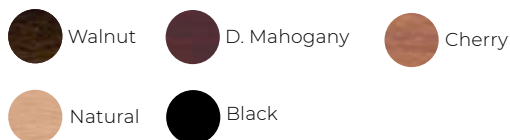





W31330



### CUSTOM OPTIONS

BTO finishes available, 50 pc. Minimum order quantity  
See Planning & Options (page 97) for more information

### DIMENSIONS AND WEIGHTS

					
Chair (18)	34"	18"	17"	17"	16 lbs
Barstool (30)	43.5"	30"	17"	17"	19 lbs



# WL511

## UPHOLSTERED - WOOD LOOK, PARSON'S BACK

Upholstered metal frame, wood-look faux finish with pullover upholstered seat. Heavy-duty 18 gauge steel frame

WL51118



WL51130  
GRI



WL511  
Dual Tone  
Shown

### SEAT & BACK

Padded, upholstered back & web seat

### FRAME

Welded steel with faux wood-look metal finish, with black insert-style nylon glides

### QUICK SHIP CONFIGURATION

Seat & Back - Vinyl



Black

Frame - Wood Look Metal







Walnut Wood-Look

### CUSTOM OPTIONS

BTO finishes available, 50 pc. Minimum order quantity  
Upholstery: See Planning & Options (page 97)  
See Planning & Options (page 97) for more information

### DIMENSIONS AND WEIGHTS

					
Chair (18)	40"	18"	18"	18.5"	17 lbs
Barstool (30)	44"	30"	17"	18"	19 lbs



31

Just Chairs and More! · 347.617.1317  
JustChair.com · Info@JustChair.com

# W555

## UPHOLSTERED - SQUARE INSET BACK

Upholstered square padded inset back with upholstered seat, with heavy-duty steel brackets. German beech, tongue & groove hardwood construction.

W55518



### SEAT & BACK

Padded, upholstered seat

### FRAME

Full joinery, factory sealed construction  
European beech wood, with tan, nail-in nylon glides

### QUICK SHIP CONFIGURATION

#### Seat & Back

 Black Vinyl

#### Frame

 Walnut





### STANDARD OPTIONS

FRL

### CUSTOM OPTIONS

BTO finishes available, 50 pc. Minimum order quantity  
See Planning & Options (page 97) for more information

### DIMENSIONS AND WEIGHTS

					
Chair (18)	33.5"	18"	19"	21"	20 lbs
Chair (18A)	33.5"	18"	19"	21"	22 lbs
Barstool (30)	40.5"	30"	19"	17"	24 lbs

W55530



# W589

## PULLOVER DIAMOND BUTTON UPHOLSTERED BACK

Pullover button back with webbed pullover seat. German beech, tongue & groove hardwood construction.

W58918



W58930



### SEAT & BACK

Seat: Webbed, padded and upholstered pullover. Back: Rollover with button and stitched tuft

### FRAME

Full joinery, factory sealed construction  
European beech wood, with tan, nail-in nylon glides

### QUICK SHIP CONFIGURATION

Seat & Back - Vinyl

 Black

Frame

 Walnut





### STANDARD OPTIONS

FRL

### CUSTOM OPTIONS

BTO finishes available, 50 pc. Minimum order quantity  
See Planning & Options (page 97) for more information

### DIMENSIONS AND WEIGHTS

					
Chair (18)	34"	18"	18.5"	17"	18 lbs
Barstool (30)	44"	30"	17"	17"	20 lbs



33

Just Chairs and More! · 347.617.1317  
JustChair.com · Info@JustChair.com

# C420/421

## PADDED BLACK SWIVEL BARSTOOLS

Traditional black, upholstered swivel barstools on bolted and welded steel tubular frames.



C42030



C42030X



C42130

Jumbo 20"  
Wide Seat  
Standard

### SEAT

C42030: Padded vinyl box seat  
C42130: Wide padded vinyl seat with waterfall  
Welt Cord

### BACK

C42030/C42130  
Double sided padded back with Welt Cord

### FRAME.

Welded steel tube frame, with premium nickel, insert-style swivel glides

### QUICKSHIP CONFIGURATIONS

#### Seat & Back

 Black Vinyl

#### Frame





 Chrome  
(C-42030/X only)

 Black Gloss  
(C-421 only)

### CUSTOM OPTIONS

BTO finishes available, 50 pc. Minimum order quantity  
Local customization available, no Minimum  
Upholstery: See Planning & Options (page 97) for more information

### DIMENSIONS AND WEIGHTS

					
C420 (30X)	-	30"	14"	14"	15 lbs
C420 (30)	41"	29.5"	17"	19.5"	20 lbs
C421 (30)	42.5"	31.5"	20"	17.5"	25 lbs

All Frames Include  
Metal Swivel Glides  
Standard





# M8QS

## METAL - QUICKSHIP BANQUET CHAIRS

Stocked and stackable, for fast shipment.  
Local customization available. Also factory BTO available.

M81518  
Textured  
Black Frame  
TB16



M81118  
Smooth  
Black Frame  
BG10



### SEAT

M815: 3" padded, upholstered box style  
M811: 2 ½" padded, upholstered rounded box

### BACK

Dual padded, with hidden fasteners

### FRAME

Welded, 16 gauge steel construction, with black insert-style nylon glides

### QUICKSHIP CONFIGURATIONS

Seat & Back - Vinyl



Black

M815 Frame - Textured  
M811 Frame - Smooth







Black

### BUILT TO ORDER OPTIONS

12 week lead time, 100 Minimum quantity  
Fully customizable color and style options  
See Planning & Options (page 97) for details

### DIMENSIONS AND WEIGHTS

					
M81518	36"	18"	17.5"	18"	20 lbs
M81118	37"	18"	16"	16"	13 lbs



# LA588

## UPHOLSTERED - WOOD HOSPITALITY SEATING

Fully upholstered hospitality seating, wood frame features German beech tongue & groove hardwood construction.

LA588



### SEAT & BACK

Fully upholstered padded seat and back.

### FRAME

Full joinery, factory sealed construction  
European beech wood, with tan, nail-in nylon glides  
Welded steel frame with wood fillers

### STANDARD CONFIGURATION

Seat & Back      Frame

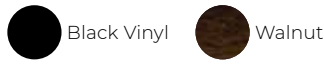

### DIMENSIONS AND WEIGHTS

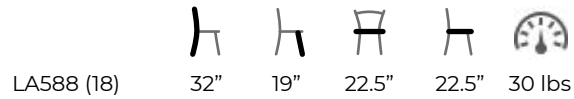

# LA556

## UPHOLSTERED - METAL LOUNGE SEATING

Fully upholstered welded steel frame hospitality seating.

LA556



Welded Steel Frame

### SEAT & BACK

Fully upholstered padded seat and back

### FRAME

Welded steel frame with wood fillers

### CASTERS

Removable Black, 300 lb test, 5 per unit  
Optional legs available

### DIMENSIONS AND WEIGHTS



# LAWAL

## UPHOLSTERED - WOOD HOSPITALITY SEATING

Fully upholstered wood frame hospitality seating, German beech tongue & groove hardwood construction.

LA587



LA554



### SEAT & BACK

Fully upholstered padded seat and back

### FRAME

Full joinery, factory sealed construction  
European beech wood, with tan, nail-in nylon glides

### STANDARD CONFIGURATION

#### Seat & Back



Black

#### Frame



Walnut

### DIMENSIONS AND WEIGHTS

LA557 (18)	30.5"	19.5"	36"	33"	32 lbs
LA554 (18)	30.5"	19.5"	34.5"	32"	30 lbs



# METAL SEATING

Steel and Aluminum Frame



04





# A220

## ALUMINUM - CLASSIC SLAT BACK

Slat back seating in brushed aluminum.  
Upholstered seat options. **For indoor or outdoor use.**

A22018



A22030



### SEAT, BACK & FRAME

Welded aluminum construction  
Includes rubber under-edge protectors, with premium vinyl covered nickel, insert style swivel glides

### SEAT OPTIONS

1" thick padded upholstered seat  
Upholstery: See Planning & Options (page 105)

### QUICK SHIP CONFIGURATION





Seat & Frame



### CUSTOM OPTIONS

Factory BTO custom colors available, 100 pc. MOQ  
Local customization available, no MOQ  
Upholstery: See Planning & Options (page 97)

### DIMENSIONS AND WEIGHTS

					
Chair (18)	33"	18"	15.5"	15"	7 lbs
Barstool (30)	42.5"	30"	15.5"	15"	13 lbs

Padded Seat Available





# M201

## METAL - BLACK LADDER BACK

Welded ladder back seating in black powder coat. Wood and upholstered seat choices.



M20118NS-BLK

M20118NS-SIL

M20130



M20118-SWL  
w/ Veneer Seat

Stacking Style  
Seats Available



### SEAT

PS: 2 ½" double-thick padded upholstered  
SS: Solid European beech wood  
VS: Veneer beech wood

### FRAME

Textured black (TB16), powder coated, welded steel frame with rust prevention treatment, with black insert-style nylon glides

### QUICK SHIP CONFIGURATION

#### Seat - Vinyl



#### Seat - Solid Wood or Veneer

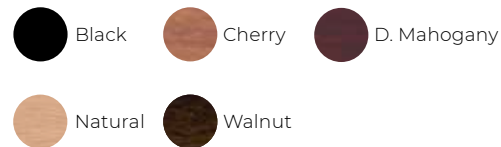





#### Frame



### CUSTOM OPTIONS

Factory BTO custom colors available, 100 pc. MOQ  
Local customization available, no MOQ  
Upholstery: See Planning & Options (page 97)

### DIMENSIONS AND WEIGHTS

					
Chair (18)	32"	18"	16.5"	17"	18 lbs
Barstool (30)	42"	30"	16.5"	17"	22 lbs
Swivel (30)	42"	30"	16.5"	17"	22 lbs



# M201

## METAL - COLOR LADDER BACK

Welded ladder back seating in clear or silver/chrome powder coat. Wood and upholstered seat choices. Note, some rust veining may occur on clear-coat versions.

M20118-CC



### SEAT

PS: 2 ½" double-thick padded upholstered  
 SS: Solid European beech wood  
 VS: Veneer beech wood

### FRAME

Clear coated, welded steel frame  
 CC: Clear-coat, industrial smoke and visible welds  
**JCM boot glides included for rust protection**

### QUICK SHIP CONFIGURATION

Seat - Vinyl



Seat - Solid Wood or Veneer

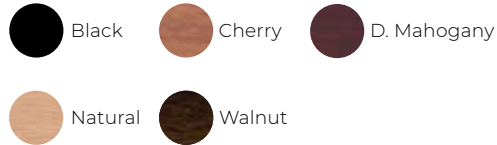

Frame



### CUSTOM OPTIONS

Factory BTO custom colors available, 100 pc. MOQ  
 Local customization available, no MOQ  
 Upholstery: See Planning & Options (page 97)

### DIMENSIONS AND WEIGHTS

Chair (18)	32"	18"	16.5"	17"	18 lbs
Barstool (30)	42"	30"	16.5"	17"	22 lbs

M20130-CC  
 w/ Veneer Seat



Foot Rest Recommended  
 (not included)

NOTE: Industrial Clear Coat is a clear coating over raw untreated steel. It is acid washed before welding and coating. But, it is not warranted against rusting.





# M271

## METAL - BLACK WINDOW BACK

Welded window back seating in black powder coat. Wood and upholstered seat choices.

M27118



### SEAT

PS: 2 ½" double-thick padded upholstered  
 SS: Solid European beech wood  
 VS: Veneer beech wood

### FRAME

Textured black (TB16), powder coated, welded steel frame with rust prevention treatment, with black insert-style nylon glides

### QUICK SHIP CONFIGURATION

#### Seat - Vinyl



#### Seat - Solid Wood or Veneer

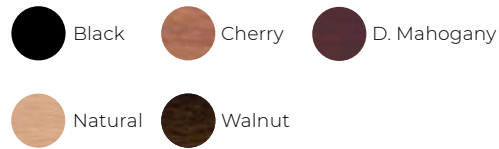

#### Frame







M27130  
w/ Solid seat



### CUSTOM OPTIONS

Factory BTO custom colors available, 100 pc. MOQ  
 Local customization available, no MOQ  
 Upholstery: See Planning & Options (page 97)

### DIMENSIONS AND WEIGHTS

					
Chair (18)	35"	18"	17.5"	18"	18 lbs
Barstool (30)	44"	30"	17.5"	18"	20 lbs

M27130-SWL  
w/ Red Padded Seat



# WL201

## METAL - WOOD LOOK LADDER BACK

Welded ladder back seating in faux wood-look powder coat. Solid wood, veneer and upholstered seat choices.

WL20118



WL20130  
w/ Solid seat



### SEAT

PS: 2 ½" double-thick padded upholstered  
 SS: Solid European beech wood  
 VS: Veneer beech wood

### FRAME

Hand grained wood-look paint over powder coated frame. Sealed with clear powder coat, with black insert-style nylon glides

### QUICK SHIP CONFIGURATION

#### Seat - Vinyl



#### Seat - Solid Wood or Veneer

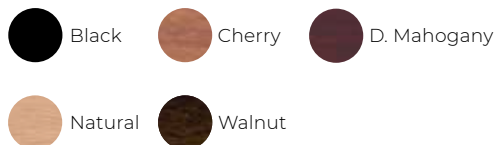





#### Frame - Wood Look Metal



### CUSTOM OPTIONS

Factory BTO custom colors available, 100 pc. MOQ  
 Local customization available, no MOQ  
 Upholstery: See Planning & Options (page 97)

### DIMENSIONS AND WEIGHTS

					
Chair (18)	34.5"	18"	17.5"	17"	18 lbs
Barstool (30)	42"	30"	17.5"	17"	22 lbs



# WL381

## METAL - WOOD LOOK SLAT BACK

Flared slat back seating in faux wood-look powder coat. Solid wood, veneer and upholstered seat choices.

WL38118  
w/ Solid seat



WL38130  
w/ Padded seat



### SEAT

PS: 2 ½" double-thick padded upholstered  
SS: Solid European beech wood  
VS: Veneer beech wood

### FRAME

Hand grained wood-look paint over powder coated frame  
Sealed with clear powder coat, with black insert-style nylon glides

### QUICK SHIP CONFIGURATION

Seat - Vinyl



Seat - Solid Wood or Veneer





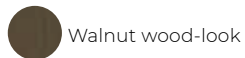

Frame



### CUSTOM OPTIONS

Factory BTO custom colors available, 100 pc. MOQ  
Local customization available, no MOQ  
Upholstery: See Planning & Options (page 97)

### DIMENSIONS AND WEIGHTS

					
Chair (18)	34"	18"	16.5"	17"	18 lbs
Barstool (30)	44"	30"	16.5"	17"	22 lbs



# M423

## MUSHROOM SWIVEL

Bolt down, steel, 360° swivel stool with padded, upholstered, backless platform seat.

M42318



M42330



M42330X-  
BARREL

### SEAT

6" Thick, double padded upholstered mushroom seat





### FRAME

Black, textured powder coated, bolt down steel frame with 16 gauge steel column on steel swivel bracket

### CUSTOM OPTIONS

Factory BTO custom colors available, 100 pc. MOQ  
Local customization available, no MOQ  
Upholstery: See Planning & Options (page 97)

### DIMENSIONS AND WEIGHTS

					
Stool (18)	-	18"	16"	16"	18 lbs
Barstool (30)	-	30"	16"	16"	23 lbs
Barrel (30X)	-	18"	16"	16"	36 lbs



Bolt-down Base  
w/ Tulip Cover



Thick Textured  
Black Powder Coat





# G425/6

## GALVANIZED TOLIX STACKABLE SEATING

Galvanized steel, stackable chair. Solid wood and upholstered seat choices. **For indoor or outdoor use.**

G42518  
Stackable



G42518A  
Wood Seat  
Stackable



G42630  
w/ Padded Seat



### SEAT, BACK & FRAME

Galvanized steel, welded construction with stacking bumpers and black insert-style rubberized plastic glides

### SEAT OPTIONS (INDOOR)

PS: 1" padded upholstered  
Stackable Wood seat

### QUICK SHIP CONFIGURATION

Seat - Vinyl



Black

Seat - Solid Wood or Veneer



Natural



Walnut

Frame







Galvanized  
Steel

### CUSTOM OPTIONS

Factory BTO custom colors available, 100 pc. MOQ  
Local customization available, no MOQ  
Upholstery: See Planning & Options (page 97)

### DIMENSIONS AND WEIGHTS

					
Chair (18)	34"	18"	14"	14"	12 lbs
Barstool (30)	46"	30"	14"	14"	14 lbs
Arm (18)	31"	18"	20"	21.5"	14 lbs



Stacking bumpers to protect seat finish



47

Just Chairs and More! · 347.617.1317  
JustChair.com · Info@JustChair.com

# G425X

## BACKLESS GALVANIZED TOLIX SEATING

Galvanized steel, stackable, backless stools. Solid wood and upholstered seat choices. **For indoor or outdoor use.**

G42518X  
Wood Seat



G42518X  
Padded Seat

G42530X



### SEAT & FRAME

Galvanized steel, welded construction with stacking bumpers, with black insert-style plastic/rubber glides

### SEAT OPTIONS (INDOOR)

PS: 1" padded upholstered (indoor)  
Stackable Wood Seat

### QUICK SHIP CONFIGURATION

Seat - Vinyl



Black

Seat - Solid Wood



Natural



Walnut

Frame - Galvanized Steel







Artistic Matte  
Galvanized

### CUSTOM OPTIONS

Factory BTO custom colors available, 100 pc. MOQ  
Local customization available, no MOQ  
Upholstery: See Planning & Options (page 97)

### DIMENSIONS AND WEIGHTS

					
Stool (18)	-	18"	12"	12"	7 lbs
Barstool (30)	-	30.5"	12"	12"	11 lbs

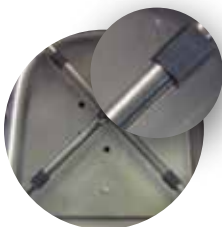

Stacking bumpers to protect seat finish



# S425

## CLEAR STEEL TOLIX SEATING

Industrial style, clear coated steel tollox style stackable chairs in clear-coat and colors. For indoor use only, some rust veining may occur. Solid wood and upholstered seat choices.



S42518  
Stackable  
Wood Seat



S42630

### SEAT & FRAME

Powder coated steel, welded construction with stacking bumpers, with black insert-style, plastic/rubber glides

### SEAT OPTIONS

PS: 1" padded upholstered  
Stackable Wood Seat

### QUICK SHIP CONFIGURATION

Seat - Vinyl



Black

Seat - Solid Wood or Veneer



Natural



Walnut

Frame







Clear  
Coat

### CUSTOM OPTIONS

Factory BTO custom colors available, 100 pc. MOQ  
Local customization available, no MOQ  
Upholstery: See Planning & Options (page 97)

### DIMENSIONS AND WEIGHTS

					
Chair (18)	34"	18"	14"	14"	12 lbs
Barstool (30)	46"	30"	14"	14"	14 lbs

NOTE: Industrial Clear Coat is a clear coating over raw untreated steel. It is acid washed before welding and coating. But, it is not warranted against rusting.



Stacking bumpers to protect seat finish.



# S425

## STEEL TOLIX STACKABLE SEATING

Powder coated galvanized steel tolix style chairs in clear-coat and colors. For indoor use only. Solid wood and upholstered seat choices. **For indoor or outdoor use.**

S42518-BLK  
Indoor/ Outdoor  
Stackable



S42518-RED  
Indoor/ Outdoor  
Stackable



S42630-RED  
Indoor/ Outdoor

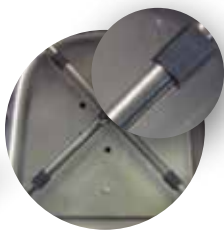

Stacking bumpers to  
protect seat finish

### SEAT & FRAME

Powder coated galvanized steel, welded construction with stacking bumpers, with black insert-style, rubber glides

### SEAT OPTIONS (INDOOR)

PS: 1" padded upholstered  
Stackable Wood Seat

### QUICK SHIP CONFIGURATION

Seat - Vinyl



Black

Seat - Solid Wood



Natural



Walnut

Frame - Galvanized Steel



Red



Black

### CUSTOM OPTIONS

Factory BTO custom colors available, 100 pc. MOQ  
Local customization available, no MOQ  
Upholstery: See Planning & Options (page 97)

### DIMENSIONS AND WEIGHTS

					
Chair (18)	34"	18"	14"	14"	12 lbs
Barstool (30)	46"	30"	14"	14"	14 lbs



50

Just Chairs and More! · 347.617.1317  
JustChair.com · Info@JustChair.com

# UPHOLSTERED BOOTHS & BANQUETTES



05



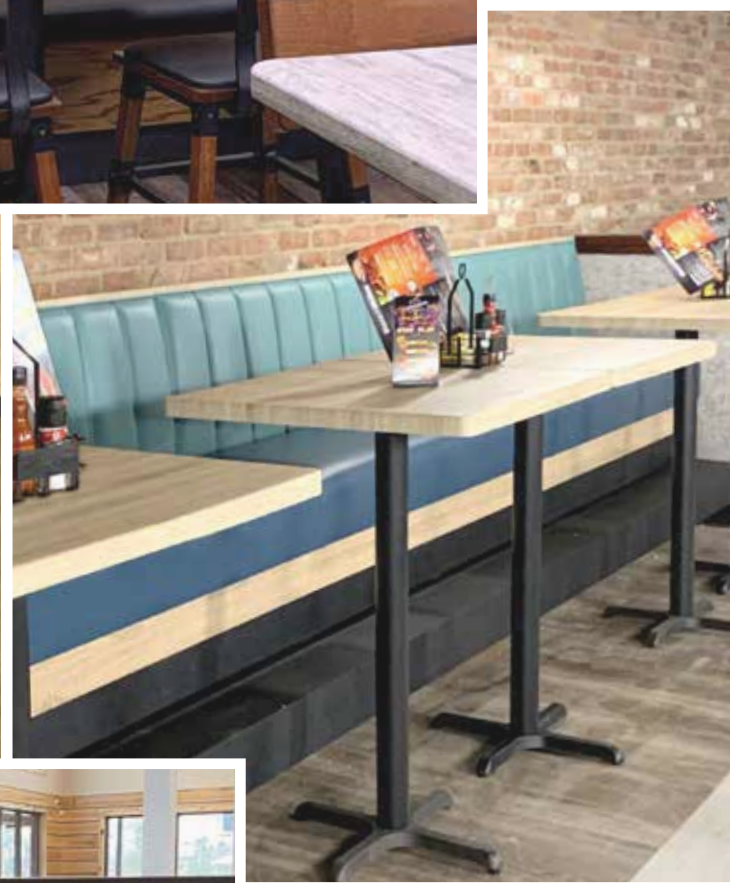

## SUPERIOR CONSTRUCTION & BUILT-IN QUALITY

JustChair's superior booth construction combines attractive styling and comfort with durability. Our booths are designed and built to last for years. All booths are specified with the highest quality materials available. All of our upholstered booths feature heavy duty computer-cut frames and are reinforced with corner blocks and hardened steel supports.

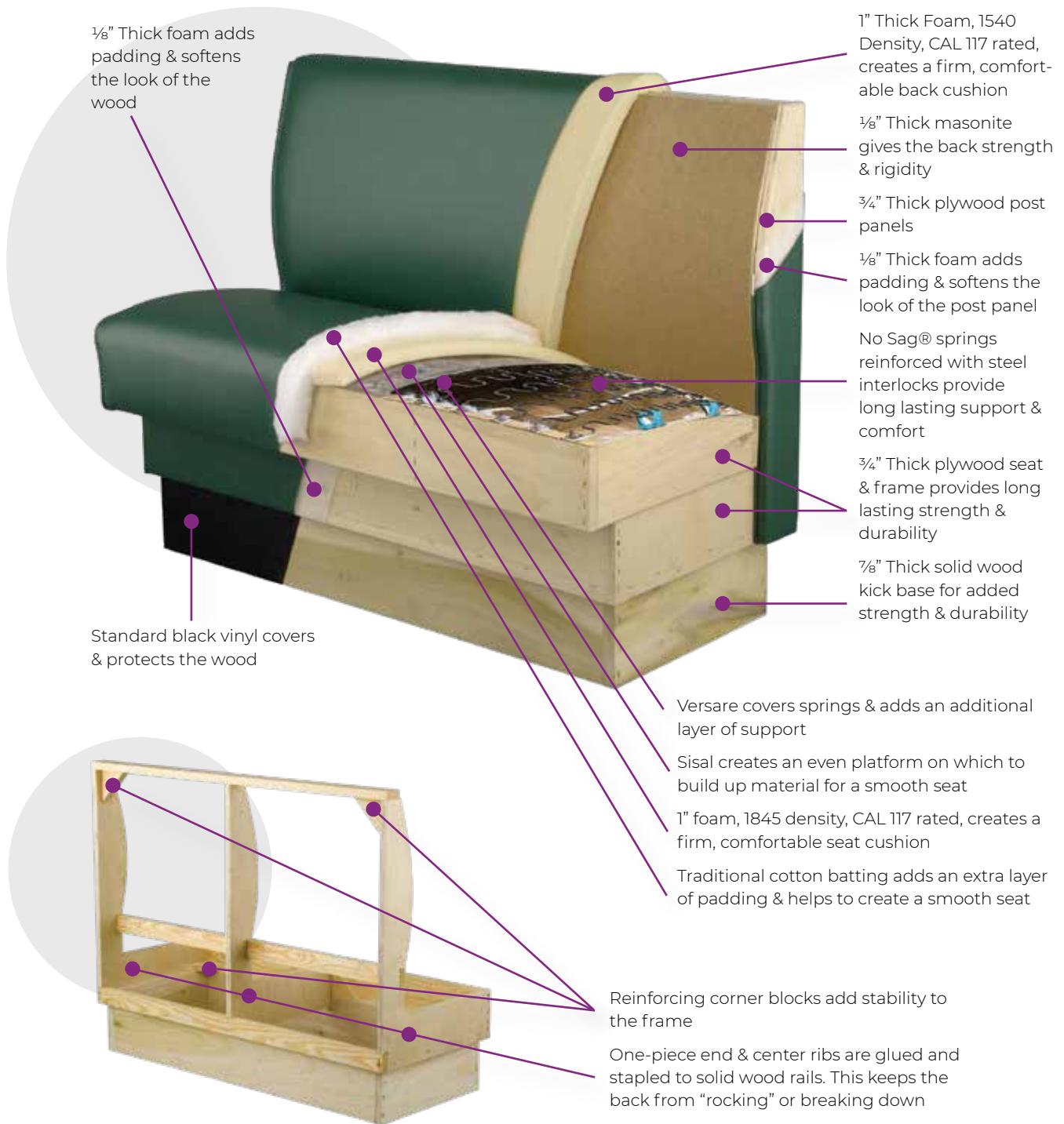

1/8" Thick foam adds padding & softens the look of the wood

1" Thick Foam, 1540 Density, CAL 117 rated, creates a firm, comfortable back cushion

1/8" Thick masonite gives the back strength & rigidity

3/4" Thick plywood post panels

1/8" Thick foam adds padding & softens the look of the post panel

No Sag® springs reinforced with steel interlocks provide long lasting support & comfort

3/4" Thick plywood seat & frame provides long lasting strength & durability

7/8" Thick solid wood kick base for added strength & durability

Standard black vinyl covers & protects the wood

Versare covers springs & adds an additional layer of support

Sisal creates an even platform on which to build up material for a smooth seat

1" foam, 1845 density, CAL 117 rated, creates a firm, comfortable seat cushion

Traditional cotton batting adds an extra layer of padding & helps to create a smooth seat

Reinforcing corner blocks add stability to the frame

One-piece end & center ribs are glued and stapled to solid wood rails. This keeps the back from "rocking" or breaking down



# JB-UPL

## UPHOLSTERED PLAIN BACK BOOTHS

Solid plain back style booths and banquettes.

JBS-UPL-36



JBD-UPL-42



JBSB-UPL-48



### CONSTRUCTION FEATURES

- Heavy-Duty, all wood, computer cut frame
- Hardened steel reinforcements
- Certified CAL-117 upholstery components
- Legget & Platt No-Sagg® sinuous spring seats
- Extreme-duty ABS kick plate

### STANDARD DIMENSIONS

*All measurements facing front of booth*

Height: 36", 42" and 48"

Width Booth: 30", 48", 60", 72"

Width ½ Circle: 48"x 90"x 48"

Width ¾ Circle: 48"x 90"x 90"x 48"

Width Banquette: Built by the foot

Depth, Single: 23"

Depth, Double: 44"

### INSIDE BACK OPTIONS

- Plain padded back, standard
- Pullover back
- Matching or contrasting colors

### SEAT OPTIONS

- Vinyl or wood crumb strip
- Tall Drop Seat
- Plywood base (no-spring) padded seat

### WOOD & LAMINATE OPTIONS

- End caps, top cap, seat base or kick plate
- Standard wood finishes on oak, maple, ash or beech
- Wilsonart® or Formica® standard laminates available



# JB-UCH

## UPHOLSTERED CHANNEL-BACK

Vertical deep channel (4" to 15") back style. Booths and banquettes.

JBS-UCH-36



JBD-UCH-42



JBSB-UCH-48



### CONSTRUCTION FEATURES

- Heavy-Duty, all wood, computer cut frame
- Hardened steel reinforcements
- Certified CAL-117 upholstery components
- Legget & Platt No-Sagg® sinuous spring seats
- Extreme-duty ABS kick plate

### STANDARD DIMENSIONS

*All measurements facing front of booth*

- Height: 36", 42" and 48"
- Width Booth: 30", 48", 60", 72"
- Width ½ Circle: 48"x 90"x 48"
- Width ¾ Circle: 48"x 90"x 90"x 48"
- Width Banquette: Built by the foot
- Depth, Single: 23"
- Depth, Double: 44"

### INSIDE BACK OPTIONS

- Vertical 3 (15 ½"), 6 (7 ¾") or 12 (3 ¾") channel
- Horizontal 2, 3 or 4 channel (width depends on back height)
- Pullover back
- Matching or contrasting colors

### SEAT OPTIONS

- Vinyl or wood crumb strip
- Tall Drop Seat
- Plywood base (no-spring) padded seat

### WOOD & LAMINATE OPTIONS

- End caps, top cap, seat base or kick plate
- Standard wood finishes on oak, maple, ash or beech
- Wilsonart® or Formica® standard laminates available

JBS-UHC-42

Horizontal Channel



# JB-USP

## UPHOLSTERED STITCHED-PANEL BOOTHS

Vertical stitched channel in matching or multiple colors. 15-1/2" wide vertical panels standard. Booths and banquettes.

JBS-USP-36



JBD-USP-42



JBSB-USP-48



### CONSTRUCTION FEATURES

- Heavy-Duty, all wood, computer cut frame
- Hardened steel reinforcements
- Certified CAL-117 upholstery components
- Legget & Platt No-Sagg® sinuous spring seats
- Extreme-duty ABS kick plate

### STANDARD DIMENSIONS

*All measurements facing front of booth*

Height: 36", 42" and 48"

Width Booth: 30", 48", 60", 72"

Width ½ Circle: 48"x 90"x 48"

Width ¾ Circle: 48"x 90"x 90"x 48"

Width Banquette: Built by the foot

Depth, Single: 23"

Depth, Double: 44"

### INSIDE BACK OPTIONS

- Multiple stitched vertical panels, 7" to 16"
- Includes vertical piping, standard
- Top-stitch separation stitching, optional
- Pullover back
- Matching or contrasting colors

### SEAT OPTIONS

- Vinyl or wood crumb strip
- Tall Drop Seat
- Plywood base (no-spring) padded seat

### WOOD & LAMINATE OPTIONS

- End caps, top cap, seat base or kick plate
- Standard wood finishes on oak, maple, ash or beech
- Wilsonart® or Formica® standard laminates available

JBS-USP-42

Shown with  
Metal Legs





# JB-UVB

## UPHOLSTERED V-BACK BOOTHS

Retro styled, V-back, stitched channel backs in contrasting colors. Booths and banquettes.

JBS-UVB-36



JBD-UVB-42



JBSB-UVB-48



### CONSTRUCTION FEATURES

- Heavy-Duty, all wood, computer cut frame
- Hardened steel reinforcements
- Certified CAL-117 upholstery components
- Legget & Platt No-Sagg® sinuous spring seats
- Extreme-duty ABS kick plate

### STANDARD DIMENSIONS

*All measurements facing front of booth*

Height: 36", 42" and 48"

Width Booth: 30", 48", 60", 72"

Width ½ Circle: 48"x 90"x 48"

Width ¾ Circle: 48"x 90"x 90"x 48"

Width Banquette: Built by the foot

Depth, Single: 23"

Depth, Double: 44"

### INSIDE BACK OPTIONS

- V-Back, retro style, with piping, standard
- Top-stitch separation stitching, optional
- Pullover back
- Matching or contrasting colors

### SEAT OPTIONS

- Vinyl or wood crumb strip
- Tall Drop Seat
- Plywood base (no-spring) padded seat

### WOOD & LAMINATE OPTIONS

- End caps, top cap, seat base or kick plate
- Standard wood finishes on oak, maple, ash or beech
- Wilsonart® or Formica® standard laminates available



# JB-SBT

## UPHOLSTERED BUTTON-TUFT BOOTHS

Diamond (standard) or square stitched button tuft backs. Booths and banquettes.

JBS-SBT-36



JBD-SBT-42



JBSB-SBT-48



### CONSTRUCTION FEATURES

- Heavy-Duty, all wood, computer cut frame
- Hardened steel reinforcements
- Certified CAL-117 upholstery components
- Legget & Platt No-Sagg® sinuous spring seats
- Extreme-duty ABS kick plate

### STANDARD DIMENSIONS

*All measurements facing front of booth*

- Height: 36", 42" and 48"
- Width Booth: 30", 48", 60", 72"
- Width ½ Circle: 48"x 90"x 48"
- Width ¾ Circle: 48"x 90"x 90"x 48"
- Width Banquette: Built by the foot
- Depth, Single: 23"
- Depth, Double: 44"

### INSIDE BACK OPTIONS

- Stitched button tuft, diamond or square, standard
- Hand-folded diamond button tuft (-HFT)
- Puffed stitching without buttons

### SEAT OPTIONS

- Vinyl or wood crumb strip
- Tall Drop Seat
- Plywood base (no-spring) padded seat

### WOOD & LAMINATE OPTIONS

- End caps, top cap, seat base or kick plate
- Standard wood finishes on oak, maple, ash or beech
- Wilsonart® or Formica® standard laminates available



JBS-SBT

Square Stitched  
Button Tuft  
Shown

JBS-SBT-HFT

Hand Folded  
Button Tuft  
Shown



# JB-WAIT

## BACKLESS WAIT BENCHES

Upholstered and wood frame backless wait benches. Sold in standard sizes or by the foot.

JB-WAIT



JB-TWAIT  
Tall Seat



JB-WFWAIT  
Bench



### CONSTRUCTION FEATURES

- Choose from fully upholstered or wood frame
- Heavy-Duty, all wood, computer cut frame
- Hardened steel reinforcements
- Certified CAL-117 upholstery components
- Legget & Platt No-Sagg® sinuous spring seats
- Extreme-duty ABS kick plate
- Easily removable seat

### STANDARD DIMENSIONS

*All measurements facing front of bench*  
Height: 18-19"  
Width, Standard: 48"  
Width, Banquette: Built by the foot  
Depth: 23"

### OPTIONS

- Corner or Circle Banquette versions
- Wood or steel legs (WAIT or TWAIT)
- Wood kick plate or seat base (WAIT or TWAIT)
- Laminate kick plate or seat base (WAIT or TWAIT)
- See pages 109 for wood finish option

### STANDARD VINYL

See pages 110 - 114 for vinyl & fabric options



## JUSTCHAIR BOOTH PARTS & HEIGHT

When describing booths, terminology is key. Booths are measured and described as though standing in front and facing the booth. From left to right.

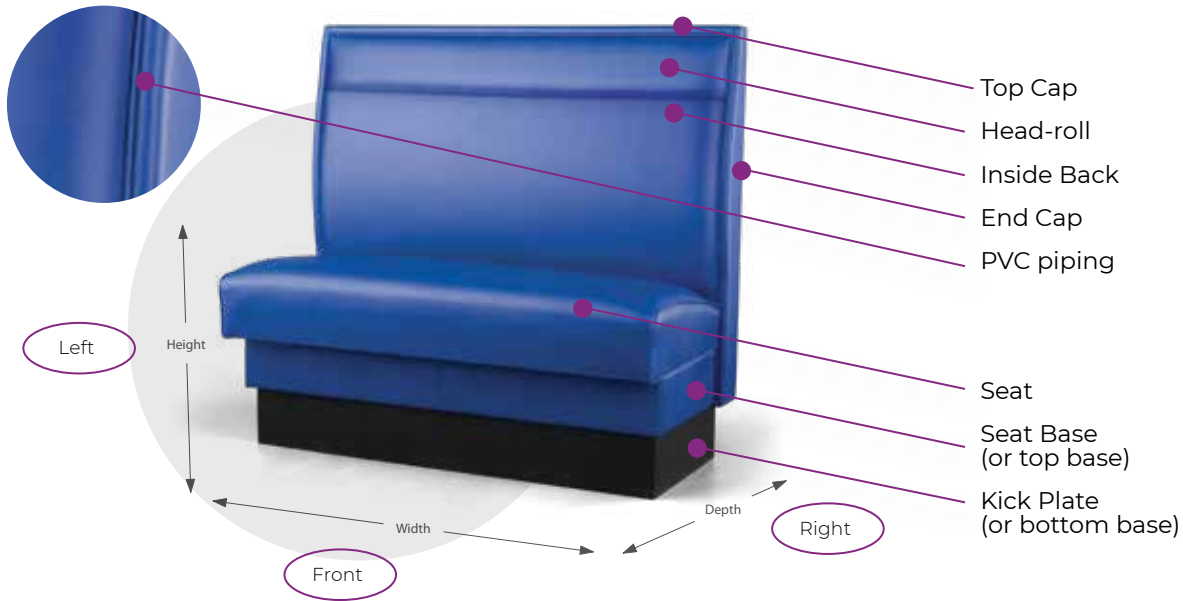

### BOOTH CIRCLE STYLES

Shown from the top

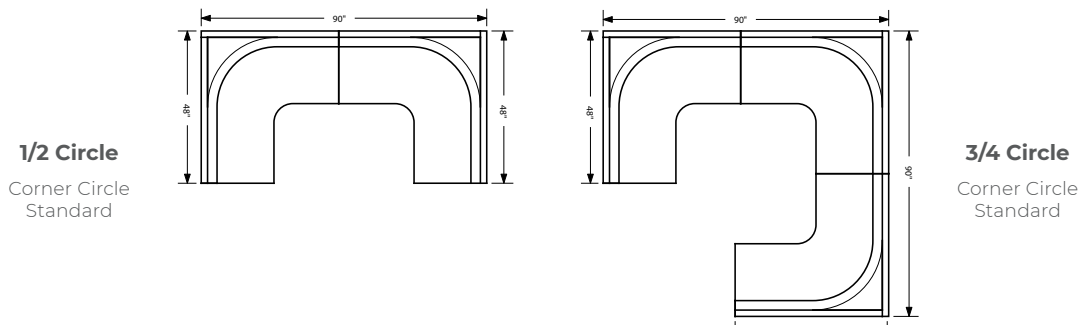

### BACK HEIGHTS

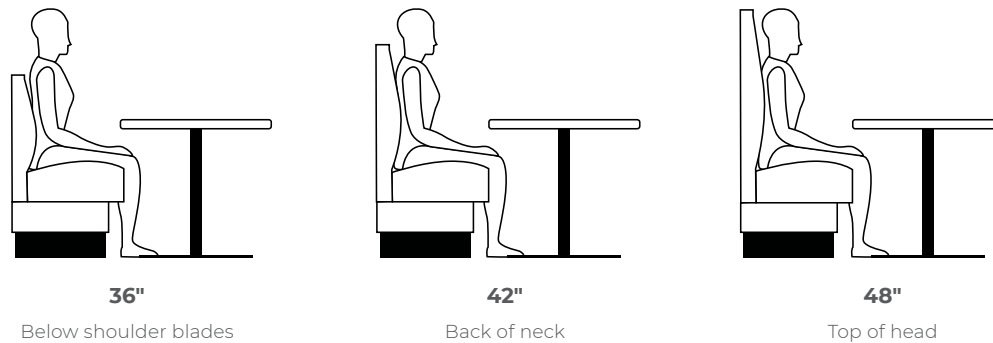

# WOOD BOOTHS

Beech, Ash and Maple Frames



06



# JB-WT

## WOOD TIMBER FRAME BOOTHS

Hardwood Timber Frame style booth, with padded seat and padded back.

JBS-WT-UPL-36



### CONSTRUCTION FEATURES

Sturdy solid oak frame  
Mortise & tenon construction throughout

### STANDARD DIMENSIONS

*All measurements facing front of booth*

Height: 36", 42" and 48"

Width Booth: 30", 48", 60", 72"

Width ½ Circle: 48"x 90"x 48"

Width ¾ Circle: 48"x 90"x 90"x 48"

Width Banquette: Built by the foot

Depth, Single: 21"

Depth, Double: 41"

JBD-WT-UCH-42



### INSIDE BACK OPTIONS

Plain Upholstered floating back pad (-UPL)  
Vertical Channel floating back pad (-UCH)  
Horizontal Channel floating back pad (-UHC)  
Stitched Button Tuft floating back pad (-SBT)

### STANDARD WOOD FINISHES

Solid Oak



Black



Cherry



D. Mahogany



Natural



Walnut

JBS-WT-SBT-36



JBS-WT-UHC-36



# JB-WPF

## WOOD PANEL FRAME BOOTHS

Choose from Bead Board, Oak or Distressed Pine Panels.

JBS-WPF-4272

Oak Horizontal  
Bead-board



JBS-WPF-4272

Oak Vertical  
Bead-board



JBS-WPF-4272

Faux Plank Rustic  
Walnut



### CONSTRUCTION FEATURES

Select solid wood and veneered composite construction

### STANDARD DIMENSIONS

*All measurements facing front of booth*

Height: 36", 42" and 48"

Width Booth: 30", 48", 60", 72"

Width ½ Circle: 48"x 90"x 48"

Width ¾ Circle: 48"x 90"x 90"x 48"

Width Banquette: Built by the foot

Depth, Single: 23"

Depth, Double: 44"

### INSIDE BACK OPTIONS

Horizontal or vertical bead board

Horizontal groove (faux plank)

Hanging back pad

### STANDARD WOOD FINISHES

Solid Oak



Black



Cherry



D. Mahogany



Natural



Walnut



Solid plank rustic  
joinery

Wood booth shown  
with standard vinyl  
outside back



63

Just Chairs and More! · 347.617.1317  
JustChair.com · Info@JustChair.com

# JB-WSS

## WOOD PADDED SPRING SEAT BOOTH

With or without panel back.

JBS-WSS-48



JBD-WSS-60  
with Panel



JBD-WSS-48  
with Panel



### CONSTRUCTION FEATURES

Hardwood and veneer construction. Choose with or without privacy panel. Booth is charged by total finished height.

### STANDARD DIMENSIONS

*All measurements facing front of booth*

Height: 36", 42", 48", 54" and 60" (total with or without panel)

Width Booth: 30", 48", 60", 72"

Width ½ Circle: 48"x 90"x 48"

Width ¾ Circle: 48"x 90"x 90"x 48"

Width Banquette: Built by the foot

Depth, Single: 23"

Depth, Double: 44"

### INSIDE BACK OPTIONS

With or without decorative privacy panel

Plain Upholstered back (-UPL)

Vertical Channel back (-UCH)

Stitched Button Tuft back pad (-SBT)

### SEAT OPTIONS

Vinyl or wood crumb strip

Tall Drop Seat

Plywood base (no-spring) padded seat

### STANDARD WOOD FINISHES

Solid Oak



Black



Cherry



D. Mahogany



Natural



Walnut



Wood booth shown  
with standard vinyl  
outside back



64

Just Chairs and More! · 347.617.1317  
JustChair.com · Info@JustChair.com

# JB-WCP

## WOOD CLAD PLATFORM BOOTH

Available with wood clad inside back, or with hanging back pad. Choose from distressed pine or standard stained wood.

JBS-WCP-48  
Distressed Back



JBD-WCP-48  
Distressed Back



JBD-WCP-48  
Distressed Pine  
Walnut finish  
Shown with  
full size  
29" tall back pad



JBD-WCP-48  
Oak - Natural  
Shown with  
full size  
29" tall back pad



### CONSTRUCTION FEATURES

Solid wood plank clad exterior on full wood frame and ABS kick plate.

### STANDARD DIMENSIONS

*All measurements facing front of booth*

Height: 36", 42" and 48"

Width Booth: 30", 48", 60", 72"

Width Banquette: Built by the foot

Depth, Single: 24"

Depth, Double: 45"

### INSIDE BACK OPTIONS

Hanging back pad

### STANDARD WOOD FINISHES

Hand distressed pine, standard

Also available in oak, ash, or cherry



Black



Cherry



D. Mahogany



Natural



Walnut



# JB-WBBO

## WOOD BEAD-BOARD OPEN BASE BOOTH

JBS-WBBO-36



JBD-WBBO-42



### CONSTRUCTION FEATURES

Hardwood plywood & solid wood construction

### STANDARD DIMENSIONS

*All measurements facing front of booth*

Height: 36", 42" and 48"

Width Booth: 30", 48", 60", 72"

Width Banquette: Built by the foot

Depth, Single: 23"

Depth, Double: 44"

### INSIDE BACK OPTIONS

Horizontal or vertical bead board

Hanging back pad

### STANDARD WOOD FINISHES

Solid Oak



Black



Cherry



D. Mahogany



Natural



Walnut





# CONTOUR SEATING

Cluster Style Intergrated Seating Units



07

# CONTOUR

JustChair's steel frame contour seating is designed and built to last and is easier to assemble than competitive brands. Seat mounting hardware is pre-attached at the factory and the frames require no assembly, saving money by reducing installation time.



Super-duty, 5 layer molded design. Holds firm and lasts for years.

Exclusive, (no assembly) heavy-duty one-piece 14 gauge welded steel frame. Table support is welded to the frame. The table attaches to the support with (6) screws

Seat mounting hardware is pre-attached at the factory to make set up fast and easy.

High impact polymer glides easily thread into the frame and will not cut the floor surface. The glides have an anchor hole if installation requires the booth be fixed to the floor



# CONTOUR

## CONTOUR SERIES SINGLE TABLE UNITS

CONT-WSS-42  
Single Laminate  
Seating w/  
T-mold Top



CONT-IS-44  
Double Laminate  
Seating w/  
DesignChoice Top



### CONSTRUCTION FEATURES

Rugged one piece welded steel frame. Heavy-duty molded seats. Choice of table top. Sold in complete single table units.

### STANDARD DIMENSIONS

*All measurements facing front of booth seat*

Height: 36"

Width Booth: 23", 42", 44", 47", 59"

Depth, Table Unit: 63" (65" floor spacing)

### BACK OPTIONS

Outside: brown liner, standard

Outside: black liner or laminate, optional

Inside: floating back pad, with or without piping

### FRAME OPTIONS

Black satin standard, other colors optional

6" stretch frame (additional belly/top room)

### TABLE TOP OPTIONS

Laminate: Vinyl Edge, Wood Edge, T-Mold.

DesignChoice™ Thermo-formed, GR1, GR2, GR3

Solid Wood. Beech, Ash, Oak, Maple

Custom Top Sizes

### FRAME STYLES

Wall



Island

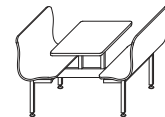

ADA

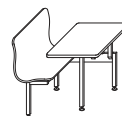

Bench



# CONT-PLUS

## CONTOUR PLUS TABLE UNITS

CPLUS-1TU

Single Table Unit



CPLUS-2TU

Double Table Unit

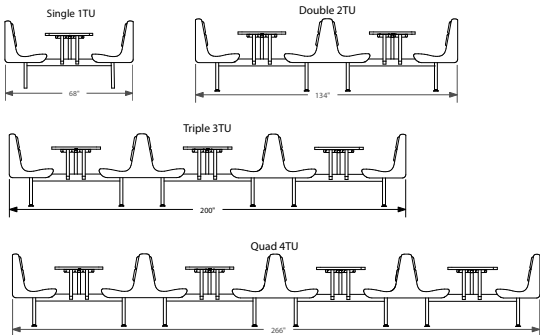

Each booth unit includes: 2 Seats, 1 Top, 1 Welded frame

### CONSTRUCTION FEATURES

Solid oak trim booth seatings with rugged one piece welded steel frame. Heavy-duty molded seats Choice of table top Sold in complete table units .

### STANDARD DIMENSIONS

*All measurements facing front of booth seat*

Height: 36"

Width Booth: 23", 42", 44", 47", 59"

Depth, Single Table Unit: 68"

Depth, Double Table Unit: 134"

Depth, Triple Table Unit: 200"

Depth, Quad Table Unit: 266"

Top: 24" depth, width to match booth seating width

### BACK OPTIONS

Outside: brown liner, standard

Outside: black liner, wood or laminate, optional

Inside: floating back pad, with or without piping

### FRAME OPTIONS

Black satin standard, other colors optional

6" stretch frame (additional belly/top room)

### TABLE TOP OPTIONS

Laminate: Vinyl Edge, Wood Edge, T-Mold.

DesignChoice™ Thermo-formed, GR1, GR2, GR3

Solid Wood. Beech, Ash, Oak, Maple

Custom Top Sizes

### FRAME STYLES

Wall

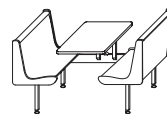

Island

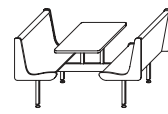

ADA

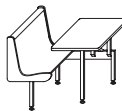

Bench



# CONT-PREM

## CONTOUR PREMIUM TABLE UNITS

CPREM-1TU

Single Table Unit



CPREM-2TU

Double Table Unit

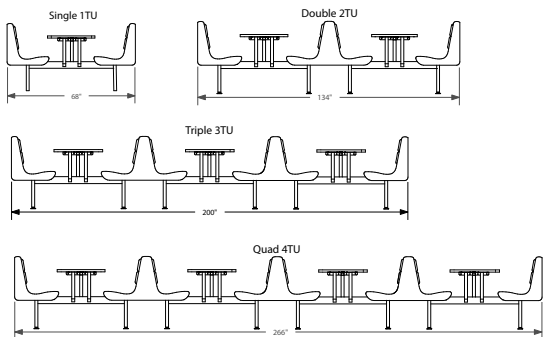

Each booth unit includes: 2 Seats, 1 Top, 1 Welded frame

### CONSTRUCTION FEATURES

Solid oak trim booth seatings with rugged one piece welded steel frame. Heavy-duty molded seats with integrated back pads. Choice of table top. Sold in complete table units.

### STANDARD DIMENSIONS

*All measurements facing front of booth seat*

Height: 36"

Width Booth: 23", 42", 44", 47", 59"

Depth, Single Table Unit: 68"

Depth, Double Table Unit: 134"

Depth, Triple Table Unit: 200"

Depth, Quad Table Unit: 266"

Top: 24" depth, width to match booth seating width

### BACK OPTIONS

Outside: brown liner, standard

Outside: black liner, wood or laminate, optional

### FRAME OPTIONS

Black satin standard, other colors optional  
6" stretch frame (additional belly/top room)

### TABLE TOP OPTIONS

Laminate: Vinyl Edge, Wood Edge, T-Mold.

DesignChoice™ Thermo-formed, GR1, GR2, GR3

Solid Wood. Beech, Ash, Oak, Maple

Custom Top Sizes

### FRAME STYLES

Wall

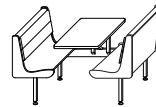

Island

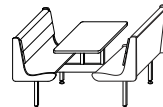

ADA



Bench





# CLUS

## CLUSTER SWIVEL TABLE UNITS

CLUS-IS-4S



CT271



66830X

Walnut Button



CJ016



CJ310

### CONSTRUCTION FEATURES

Top: Choice of 1 3/8" thick, grade 1, HPL laminated with vinyl, self or wood edge or DesignChoice™.

### INSIDE BACK OPTIONS

Choose from windows, ladder-back or criss-cross

### SEAT OPTIONS

Choice of Metal back, GRI Padded Seat Swivel or fixed movement

### FRAME STYLES

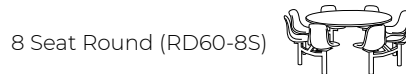
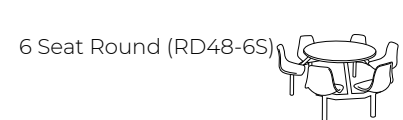
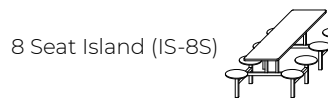
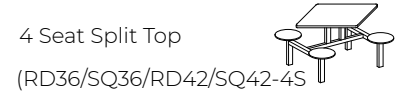
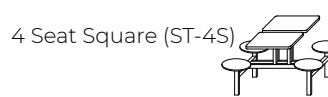
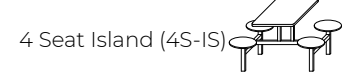
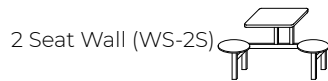

# TABLE TOPS (& BASES)

DesignChoice™, Laminate, Veneer and Wood

08



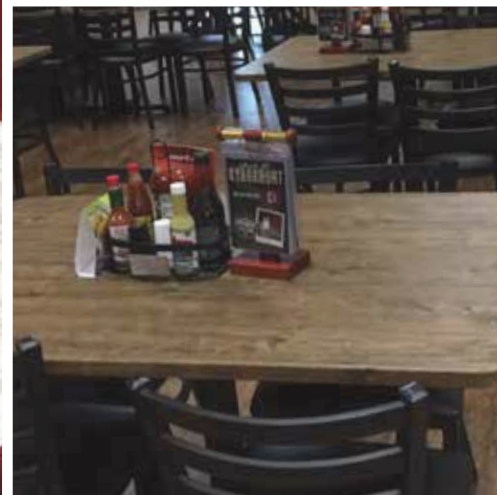



## DESIGNCHOICE™ THERMO-FORMED TOPS

Seamless 3D laminated tops on a thick core, sealed with a black backer. Extremely durable. The beauty and feel of wood with the strength of laminate.

TTDC  
Shiplap



TTDC  
Silver birch

TTDC  
Calcutta Warm  
Premium Stone







TTDC  
Milano Tan Marble  
Premium Stone



TTDC  
Gemstone

### STANDARD SIZES

Most available in QuickShip colors, 1-1/8" thick

	24" x 30" 23 lbs		24" R 16 lbs
	24" x 42" 36 lbs		30" R 28 lbs
	30" x 45" 45 lbs		36" R 48 lbs
	30" x 48" 46 lbs		48" R 65 lbs
	30" x 60" 59 lbs		Booth Cut
	30" x 72" 68 lbs		42" x 42" 59 lbs
	36" x 72" 81 lbs		Drop Leaf
	30" x 30" 32 lbs		36" to 51"R 81 lbs
	36" x 36" 41 lbs		42" to 60"R 113 lbs
	42" x 42" 59 lbs		

### TEXTURES

Available in multiple textures: (R) Rustic, (G) Grain, (P) Partial Grain, (M) Matte, (T) Textured, (S) Satin

### MOISTURE RESISTENT OPTION (MR)

Available with an outdoor MDF core, and double wrapped for use on covered patios

### CUSTOM OPTIONS

Umbrella holes

1.5" thick table top

BTO finishes and sizes available, 50 pc. Minimum order quantity  
See Planning & Options (page 97) for more information



# DESIGNCHOICE™ THERMO-FORMED TOPS

Seamless 3D laminated tops on a thick core, sealed with a black backer. Extremely durable. The beauty and feel of wood with the strength of laminate.

## QUICKSHIP COLORS (GR1)

1-2 week lead time.  
Rustic 3-D textures.

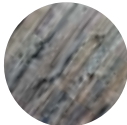

Shiplap  
169-R



Porch Swing  
170-R



Silver Birch  
171-R

## SPECIAL ORDERS (GR2)

8-10 week lead time.



Boardwalk  
163-R



Skye  
174-R



Rosewood  
150-R



Tete-E-Tete  
155-R

## PREMIUM STONE COLLECTION (GR2)

Stone colors, eased edges and corners.



Calcutta  
Warm  
226-M



Natural  
Taupe  
227-S



Evening  
Storm  
229-S

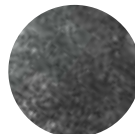

Rock Ash  
222-S



Gemstone  
Alpine  
223-S



Milano  
Tan Marble  
225-S



Sand  
Storm  
221-S



Snow  
Storm  
220-S

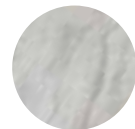

Stonecrest  
White  
219-S



Rusty Basin  
230-S

## STANDARD RUSTIC TEXTURES (GR1)



Elmwood  
167-R



Ember  
168-R



Charleston  
Oak  
151-R



Hemlocks  
Grey  
149-R



Driftwood  
144-R



Rustik  
176-R

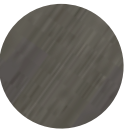

Williamsburg  
Oak  
161-R

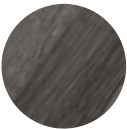

Pewter  
Pine  
160-R



Aria  
179-R



Sterling  
172-R



Bearwood  
173-R



## OUTDOOR FLEXIBILITY & CHOICES

Combine your isotop® with JustChair's TBZ outdoor - **umbrella-ready** table bases for the perfect outdoor solution. Zinc-coated, perma gray powder coated for exceptional protection against elements. All dining height (-28) bases are umbrella ready.

J AISOTT  
RCW28R



J AISOTT  
BMA28R



J AISOTT  
SWO28R



J AISOTT  
NHI36R



Original umbrella hole with grommet available.



### STANDARD SIZES

■	28" x 28"	●	28" R
	30" x 48"		36" R
	36" x 36"		48" R

### STANDARD FINISHES

● Black Marble (BMA)	● Speckled Greyson (SGR)	● Stonewashed Oak (SWO)
● Natural Hickory (NHI)	● Rustic Color Wash (RCW)	

### HIGHLY RESISTANT AGAINST

UV Rays

### CUSTOM OPTIONS

Umbrella holes  
1.5" thick table top  
BTO finishes and sizes available, 50 pc. Minimum order quantity



Heat & Flames

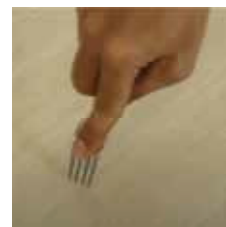

Scratching



Liquids & Sauces



Blunt Force

# TTLM

## SUPRA-EDGE™ LAMINATED TOPS

Super tough, PVC and acrylic edged tops. Solid core, high-pressure laminated tops with stain resistant backs.

TTLMAC2

Acrylic Multiplex

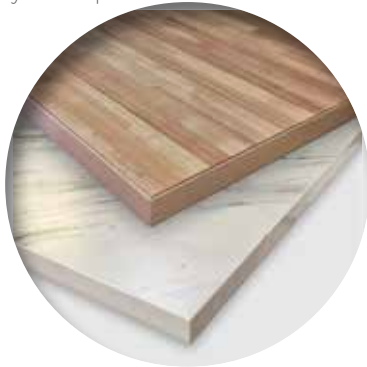

TTLMPV2

White PVC



TTLM

Drop Leaf  
w/ TBX Large Top Base



### STANDARD SIZES (5 WEEKS)

1 3/16" thick, built to order in 5 weeks

All dimensions from 24 x 24" up to 60 x 120" available

24" x 30"	27 lbs	24" R	18 lbs
24" x 42"	38 lbs	30" R	29 lbs
30" x 45"	53 lbs	36" R	40 lbs
30" x 48"	56 lbs	48" R	72 lbs
30" x 60"	59 lbs	Booth Cut	
30" x 72"	84 lbs	42" x 42"	66 lbs
30" x 84"	98 lbs	Drop Leaf	
30" x 30"	35 lbs	36" to 51"R	70 lbs
36" x 36"	50 lbs	42" to 60"R	100 lbs
42" x 42"	69 lbs		

### LAMINATE

Wilsonart® HPL -38 or -60 finishes standard

Colors: Customer choice of laminates

COM: Customer-owned-materials welcome

### EDGING

Standard: 2 MM, 3D Acrylic or PVC

Custom: Choose from wood-grain or any color

COM: Customer-owned-materials welcome

### CORNERS STYLE

90° Sharp, 2" or larger radius' available

### MOQ

Minimum Order Quantity 10 Piece standard

Smaller quantity pricing available



78

Just Chairs and More! · 347.617.1317  
JustChair.com · Info@JustChair.com

## LAMINATED TOPS WOOD, T-MOLD, PADDED

Standard laminated tops with wood or T-mold edging.

TTLMVM  
Vinyl T-mold

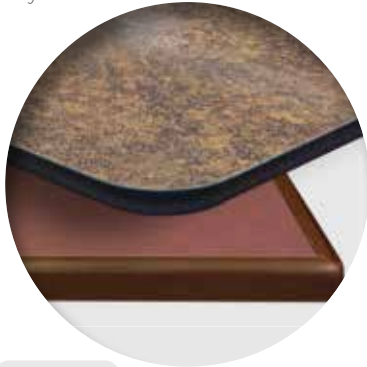

TTLMWF  
Wood Edge



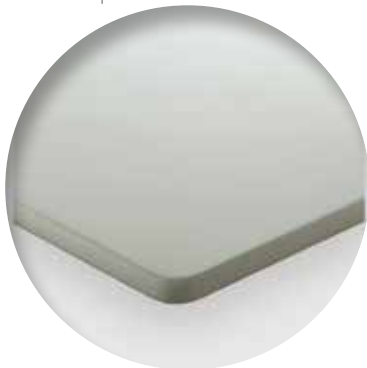

TTLMPD  
Padded top



### STANDARD SIZES (4 WEEKS)

1 3/16" thick, built to order in 5 weeks

Any non-round, dimension, up to 60 x 120" also available

	24" x 30" 22 lbs		36" R 35 lbs
	24" x 42" 32 lbs		48" R 58 lbs
	30" x 45" 40 lbs		60" R 90 lbs
	30" x 48" 45 lbs		Booth Cut
	30" x 60" 54 lbs		42" x 42" 50 lbs
	30" x 72" 65 lbs		Drop Leaf
	30" x 30" 27 lbs		36" to 51"R 90 lbs
	36" x 36" 40 lbs		42" to 60"R 120 lbs
	42" x 42" 55 lbs		

### LAMINATE

Wilsonart® HPL -38 or -60 finishes standard

Customer choice of laminates

COM: Customer-owned-materials welcome

### STANDARD COLORS

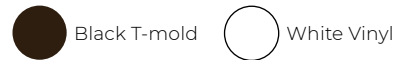

### STANDARD WOOD FINISHES

Wood edges in Walnut, DM, Cherry, Natural

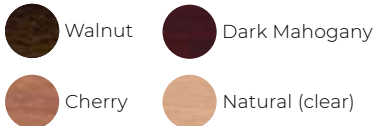

### CORNERS STYLE

T-Mold: 3" Radius Standard

Wood: 90° Sharp, 2" or larger radius' available

### MOQ

Minimum Order Quantity 5 Piece standard

Smaller quantity pricing available



# TTSC

## CUSTOM SOLID WOOD TOPS

Oak, Maple, Ash, Pine or Cherry plank in standard thickness of 1 ¼" thick, custom cut and stained. 4-6 week lead times. Lacquer finish .

TTSC-30R  
Dark Mahogany



TTSC12-2430  
Dark Mahogany



### STOCKED SIZES

1 ¼" Standard and 1 ½" thick

24" x 30"	18 lbs	24" R	18 lbs
24" x 42"	40 lbs	30" R	28 lbs
30" x 45"	53 lbs	36" R	41 lbs
30" x 48"	59 lbs	48" R	76 lbs
30" x 60"	60 lbs	Booth Cut	42" x 42" 55 lbs
30" x 72"	76 lbs	Drop Leaf	36" to 51"R 82 lbs
36" x 72"	82 lbs		42" to 60"R 110 lbs
30" x 30"	28 lbs		
36" x 36"	41 lbs		
42" x 42"	58 lbs		

### STANDARD WOOD FINISHES

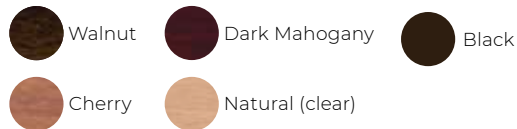

### CONSTRUCTION STYLE

Solid custom plank, ¼" radius eased edges and corners  
standard Oil based stain, finished in multi-coat pre-catalyzed lacquer, satin sheen

### CUSTOM OPTIONS

Special Sizes  
Varied radius edges and corners  
Custom finish colors  
Distressing (chain scratches and worm holes)



# TTSWRE

## RAW EDGE SOLID WOOD TOPS

These solid wood rustic live edge tops, delivery an authentic rustic appearance. QuickShip in 1 week!

TTSWRE-3030

RUWAL



TTSWRE Tops coordinate perfectly with the C912 series

### STOCKED SIZES

1 ¼" thick, QuickShip ready

■	24" x 30"	41 lbs
■	30" x 30"	42 lbs
■	30" x 48"	89 lbs
■	30" x 60"	95 lbs
■	30" x 72"	120 lbs

■	36" x 36"	80 lb
■	36" x 96"	178 lbs

### QUICK SHIP WOOD FINISHES

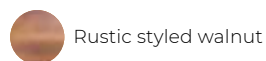

Rustic styled walnut

### CONSTRUCTION STYLE

1 ¼" solid beech wood with rough cut "live-edge". Finished in rustic walnut with a polyurethane top coat

### CORNERS STYLE

90° sharp corners only

### CUSTOM OPTIONS

BTO finishes and back styles available, 50 pc. Minimum order quantity  
See Planning & Options (page 97) for more information





# TTSW

## SOLID BEECH WOOD TOPS

Solid German beech wood tops, polyurethane finished with angled steel, embedded structure supports.

TTSW15  
Dark Mahogany





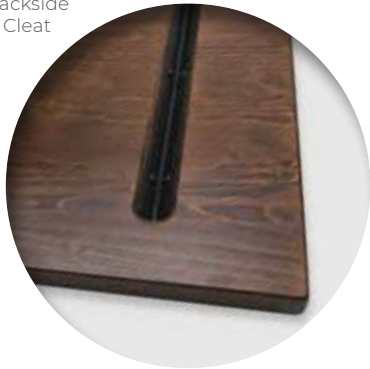

TTSW15  
Walnut

TTSW  
Backside  
Cleat



### STANDARD SIZES

QuickShip ready, 1-1/2" thick

	24" x 30" 41 lbs		24" R 42 lbs
	30" x 48" 89 lbs		30" R 114 lbs
	30" x 60" 111 lbs		
	30" x 72" 120 lbs		
	30" x 30" 42 lbs		Drop Leaf
	36" x 36" 80 lbs		36" to 51"R 105 lbs
	42" x 42" 82 lbs		42" to 60"R 140 lbs

### HIDDEN STEEL SUPPORTS

Each top includes hardened steel angle cleats embedded to prevent long-term warping

### QUICK SHIP WOOD FINISHES



### CONSTRUCTION STYLE

1 1/2" solid beech wood butcher-block style random strips, eased edges with polyurethane top coat

### CUSTOM OPTIONS

BTO finishes and sizes available, 50 pc. Minimum order quantity  
See Planning & Options (page 97) for more information



# TBX

## DOUBLE BOLTED BASES

Precision lathed steel columns with super strong cast iron bases and spiders featuring JustChair's double bolted design. Shipped with tools and instructions for easy assembly.

TBX  
End & Cross





TBX  
Round





### POWDER COAT

Standard black powder coat  
Locally customized colors available

### STANDARD SIZES - QUICKSHIP

BASES	DINING (-28)	BAR (-40)
	5" x 22" 15 lbs	5" x 22" 16 lbs
	22" x 22" 18 lbs	22" x 22" 23 lbs
	24" x 30" 22 lbs	24" x 30" 27 lbs
	30" x 30" 23 lbs	30" x 30" 23 lbs
	33" x 33" 25 lbs	33" x 33" 25 lbs
	18" round 29 lbs	18" round 32 lbs
	24" round 30 lbs	24" round 49 lbs
	30" round 98 lbs	30" round 52 lbs

### RECOMMENDED BASES TO TOP SIZES

			
24" x 30"	2222	18R	
24" x 42"	2430	18R	
30" x 45"	2430		
30" x 48"	0522(2)	2430	
30" x 60"	0522(2)		
30" x 72"	0522(2)	2222(2)	
36" x 72"	2430(2)	24R(2)	
24" x 24"	2222	18R	
30" x 30"	2430	24R	
36" x 36"	3030	30R	
42" x 42"	0522(3)	3333	30R
36/51"	3333	30R	
42/60"	0522(3)		4848



## SPECIALIZED BASES

Precision lathed steel columns with super strong cast iron bases and spiders featuring JustChair's double bolted design. Shipped with tools and instructions for easy assembly.

TBX  
Large Top



TBX  
Cantilever



TBX  
Pin Leg



Available for tops over 50"

### POWDER COAT

Standard black powder coat  
Locally customized colors available

### STANDARD SIZES - QUICKSHIP

**BASES DINING (-28)**



48" x 48" 50 lbs  
Large top base



36" x 24" 50 lbs  
Cantilever base

### RECOMMENDED TABLE SIZE

4848: 48" Round to 72" Round

Cantilever: 36" long to 48" long tops. Longer tops require a pin leg

## CONTEMPORARY TOP TABLE BASES

Precision lathed steel columns. Fully welded joints. Shipped with tools and instructions for easy assembly. **Sold individually.**



TBXU28  
U-Base



### POWDER COAT

Standard black powder coat  
Locally customized colors available  
Black vinyl screw in glides

### STANDARD SIZES

BASES	DINING (-28)	Counter (-34)	BAR (-40)
	24" x 28" 20 lbs	24" x 34" 30 lbs	24" x 40" 40 lbs
	24" x 28" 20 lbs	24" x 34" 30 lbs	24" x 40" 40 lbs

### MINIMUM TABLE SIZE

Compatible with **30" x 30"** or larger tables

TBXX28  
X-Base



# TBZ

## OUTDOOR TABLE BASES

Precision lathed steel columns with super strong cast iron bases and spiders featuring JustChair's double bolted design. Zinc coated for protection from the elements. Shipped with tools and instructions for easy assembly.

TBZ  
Round



TBZ  
End



TBZ  
Cross



### UMBRELLA OPTION (-UMB)

Bar and dining height available with or without internal umbrella support capability

### POWDER COAT

Zinc, Perma-gray powder coat  
Stainless steel hardware

### STANDARD SIZES - QUICKSHIP

BASES	DINING (-28)	BAR (-40)
	5" x 22" 15 lbs	5" x 22" 16 lbs

	22" x 22" 18 lbs	22" x 22" 23 lbs
	30" x 30" 23 lbs	30" x 30" 30 lbs

	18" Round 30 lbs	18" Round 23 lbs
	22" Round 98 lbs	22" Round 39 lbs

### RECOMMENDED BASES TO TOP SIZES



24" x 30"	2222	18R
24" x 42"		18R
30" x 45"		
30" x 48"	0522(2)	
30" x 60"	0522(2)	
30" x 72"	0522(2)	2222(2)
36" x 72"		24R(2)
24" x 24"	2222	18R
30" x 30"		24R
36" x 36"	3030	
42" x 42"	0522(3)	
36/51"		
42/60"	0522(3)	





# OUTDOOR SEATING

Perma-wood™, Aluminum & Steel



09

# PW801

## PERMA-WOOD™ GREY OUTDOOR - CHAIRS

Our Perma-wood™ Outdoor is always cool to the touch. It is designed wide and comfortable, in a range of sizes. Easily renewed with our included buffing blocks and powder-coat touchup paint.

PW80118A



PW80118



PW80130



### STOCKED CONFIGURATIONS

MODEL	DESCRIPTION	WT.
PW80118	Side Chair	12 lbs
PW80118A	Arm Chair	14 lbs
PW80124	Counter-high Stool	13 lbs
PW80130	Barstool	14 lbs

### FINISHES

#### Seat & Back



#### Frame



### CONSTRUCTION STYLE

Perma-wood™ brushed synthetic polystyrene  
Welded, powder coated aluminium components  
Stainless steel connectors.

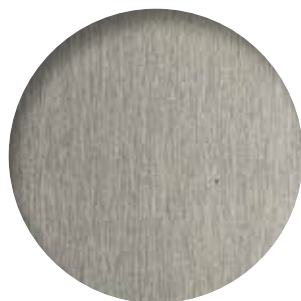

Antique Brushed  
Faux Teak



Easy cleaning and maintenance with  
included buffing bar and care kit.



88

Just Chairs and More! · 347.617.1317  
JustChair.com · Info@JustChair.com

# PW801

## PERMA-WOOD™ GREY OUTDOOR - TABLES

Our Perma-wood™ Outdoor is always cool to the touch. It is designed wide and comfortable, in a range of sizes.

PW801TT  
36R



PW801TT  
3636



PW801TT  
3030  
Bar Height



PW801TT  
3048



### STOCKED CONFIGURATIONS

MODEL	DESCRIPTION	WT.
PW801TT-2424	24" x 24" Flip Table Unit	30 lbs
PW801TT-2430	24" x 30" Flip Table Unit	35 lbs
PW801TT-3030	30" x 30" Flip Table Unit	50 lbs
PW801TT-3048*	30" x 48" Table w/ H Base	60 lbs
PW801TT-3072	30" x 72" Table w/ H Base	75 lbs
PW801TT-3636*	36" x 36" w/ Corner Legs	60 lbs
PW801TT-36R*	36" Round w/ Flared Legs	60 lbs
PW801TT-3030-B	30" x 30" Bar High Unit	60 lbs

\*Include Umbrella holes with grommet and cap

### FINISHES



Dark Grey  
Frame



Antique Faux Teak - Brushed  
Grey Slats

### CONSTRUCTION STYLE

Perma-wood™ brushed synthetic polystyrene  
Welded, powder coated aluminium components  
Stainless steel connectors  
X-base stackable design for convenient  
transport and storage (Flip Table Unit Only)  
Table top assembly required. Tools included



PW801TT  
Stackable Flip  
Table Unit



89

Just Chairs and More! · 347.617.1317  
JustChair.com · Info@JustChair.com

# PW803

## PERMA-WOOD™ TAN OUTDOOR

Our Perma-wood™ Outdoor is always cool to the touch. It is designed wide and comfortable, in a range of sizes.

PW-80318A



### STOCKED CONFIGURATIONS

MODEL	DESCRIPTION	WT.
PW80318	Side Chair	12 lbs
PW80318A	Arm Chair	14 lbs
PW80330	Barstool	14 lbs
PW803TT-2424	24" x 24" Flip Table Unit	30 lbs
PW803TT-3030	30" x 30" Flip Table Unit	50 lbs
PW803TT-3048*	30" x 48" Table w/ H Base	60 lbs
PW803TT-3636*	36" x 36" w/ Corner Legs	60 lbs

\*Include Umbrella holes with grommet and cap

### FINISHES



Champagne Frame



Natural Teak - Pressed Grain Tan Slats

PW-80318



### CONSTRUCTION STYLE

Perma-wood™ pressed synthetic polystyrene  
Welded, powder coated aluminium components  
Stainless steel connectors  
X-base stackable design for convenient transport and storage  
Table top assembly required. Tools included

PW803TT  
3048UMB



Natural Pressed Faux Teak - Tan

PW80330



PW803TT



PW803TT  
3636 w/ Corner Legs



# WL850

## BISTRO RATTAN CHAIR

The WL850 is a welded wood-look aluminum frame with poly woven seating.

WL85018



WL85030

### SEAT & BACK

WL850: Black & White synthetic (plastic) wicker. Sturdy nylon weave

### FRAME

WL850: Welded aluminum with a multi-layered powder coat in a faux walnut finish

### DIMENSIONS AND WEIGHTS



WL850	Height	Seat Depth	Seat Width	Backrest Width	Weight
Chair (18)	35"	17"	17"	16.5"	8 lbs
Barstool (30)	42.5"	30"	15.5"	15"	13 lbs

# JTA39118

## STEEL CAFE' CHAIR

The cafe style is fully welded, powder coated steel.

JTA39118



### SEAT & BACK

JTA39118 Welded flat galvanized powder coated steel

### FRAME

JTA39118 Welded galvanized power coated steel frame

### DIMENSIONS AND WEIGHTS



JTA391	Height	Seat Depth	Seat Width	Backrest Width	Weight
Chair (18)	32"	19"	17"	16"	8 lbs





## COMMERCIAL GRADE OUTDOOR UMBRELLAS

Square and octagon umbrellas available in custom configurations. Choose from a variety of fabric colors, finishes and crank/pull/tilt styles.

JUF



Classic Ball Default

Vertex

Final colors will match chosen frame finishes.

JUF

Cantilever



### STOCKED CONFIGURATIONS

MODEL	DESCRIPTION	WT.
845FM	7.5' / 2.3M Octagon	16 lbs
854FM	9' / 2.7M Octagon	18 lbs
864FM	11' / 3.5M 3.5M Octagon	22 lbs
454FM-SQ	6.5' x 6.5' / 2M Square	16 lbs
464FM-SQ	7.5' x 7.5' / 2.3m Square	17 lbs

### FINISHES

#### Frame



#### Fabric - Grade 1



# TRASH RECEPTACLES

Laminate, Melamine, DesignChoice™



10

# TRCTP

## MEL TRASH RECEPTACLES

Single and double swing door trash receptacle available in 3/4" thick economic melamine or Wilsonart® laminate.

TRCTP-MEL  
BLK



TRCTP-MEL  
WCH



TRCTP-HPL  
Potters Clay  
WA5011



### CONSTRUCTION FEATURES

- Swing door on full length piano hinge
- Magnetic push to open/lock liner cabinet
- Vinyl Lettering
- 3/4" commercial particle board substrate
- Includes 35 gallon liner
- Melamine laminate finish standard
- Optional Wilsonart® HPL laminate finishes available

### STANDARD MEASUREMENTS

- Single: 21" wide by 22" deep by 44" tall
- Double: 41.25" wide by 22" deep by 44" tall

### MELAMINE FINISHES

#### Solid Colors



#### Wood grain Colors

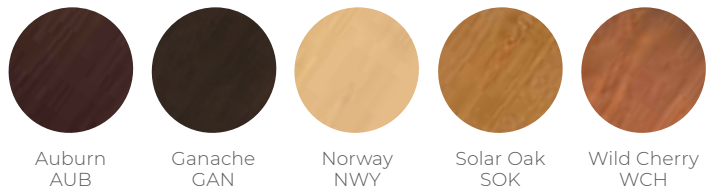

#### Premium Wood grain Colors

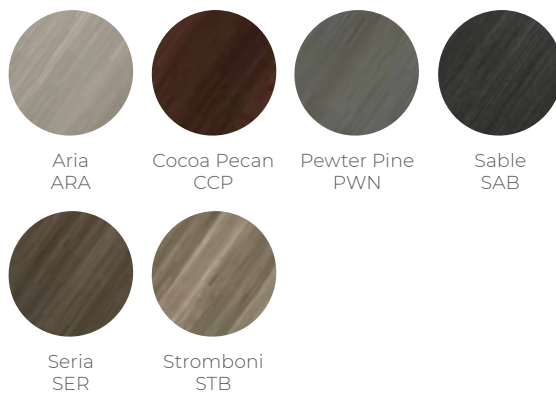

# TRCTP

## HPL TRASH RECEPTACLES

Standard and Double trash receptacle available, built of heavy-duty 1.1" thick particle board substrate with HPL laminate, and vinyl t-mold edging.

TRCPT-HPL  
Black



### CONSTRUCTION FEATURES

- Swing door for easy trash disposal
- Stainless steel spill protectors
- Interior welded steel base frame with adjustable levelers
- 1.1" commercial particle board substrate
- Vinyl Lettering
- Includes 35 gallon liner
- Magnetic push to open/lock liner cabinet
- HPL Laminate finish with vinyl t-mold edging

### STANDARD MEASUREMENTS

- Single: 23" wide by 23" deep by 48" tall
- Double: 45" wide by 23" deep by 48" tall

### HIGH-PRESSURE LAMINATE FINISHES

- Wilsonart® or Formica® HPL laminate
- T-mold edges color are limited. Contact sales for options
- Standard T-Mold Edge Colors

TRCPT-11SH  
Biltmore  
Mahogany



Black  
BLK

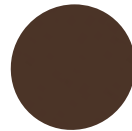

Brown  
BRN



Hickory  
HICK



Natural  
NAT

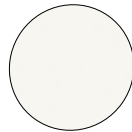

White  
WHT



# TRCTP

## DESIGNCHOICE™ TRASH RECEPTACLES

Center hole trash receptacles built with DesignChoice™ and HPL laminate finishes.

TRCTP-  
253039X



### CONSTRUCTION FEATURES

- 10" Top recessed drop for easy trash disposal
- Magnetic push to open/lock liner cabinet
- ¾" commercial particle board substates
- 1.5" DesignChoice™ Thermo-formed top
- HPL Laminate finish
- ABS textured kick plate
- Available with top shelf
- Does not include 32 gallon liner

### STANDARD MEASUREMENTS

30" wide by 25.5" deep by 39.5" tall

### FINISHES

Wilsonart® or Formica® HPL laminate  
DesignChoice™ Thermo-Formed tops

TRCTP-  
253039-SHELF





# PLANNING & OPTIONS

Space Planning, Colors, Options

11



# OPTIONS

## WOOD SEATING OPTIONS

Options below are available on most wood chairs and barstools as indicated on their product pages.

PIB w/ Welt



POB w/ DN



POS w/ DN



FRL-B

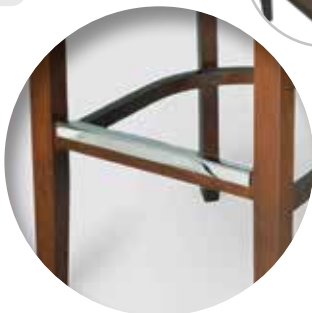

Top stitch  
POS Available

### PIB - PADDED INSIDE BACK

Includes single Welt Piping border

### POB - PULLOVER BACK

Requires decorative nails on W388

### POS - PULLOVER SEAT

Upholstered covered seat frame and upper front legs  
Decorative nails available  
Deep Pullover also available

### DN - DECORATIVE NAILS

Available in Pewter, Silver, or Brass colors

### FOOT RAIL GUARD

FRL-S: Silver colored guard  
FRL-B: Brass colored guard

### LOCAL CUSTOMIZATION

Items marked for local customization are refinished or reupholstered in the US with shorter lead times and smaller MOQ's than international factory customized products

Costs vary depending on quantity and style  
Quoted on a project-by-project basis



# OPTIONS

## JUSTCHAIR CUSTOM BOOTH OPTIONS

Booths can be custom built to fit your layout. Start with a standard design, then add custom options to fit your needs. The options below are options to the standard versions on the product page.

JBD42

Headroll  
Wood End/Top Caps  
Wood Kick Plate  
60" Wide



### END CAPS & TOP CAPS

Contrasting Upholstery Colors  
DesignChoice™  
Solid wood, with or without welt piping  
HPL Laminate

### KICK PLATES OR LEGS

Vinyl or Plastic Kick Plate options  
Standard wood legs. (in lieu of kick plate)  
Premium wood legs. (in lieu of kick plate)  
Metal legs. (in lieu of kick plate)

### BAR HEIGHT SHELF BASE

ABS Bar height with or without foot shelf  
Wood Bar height with or without foot shelf  
HPL Laminate with or without foot shelf

### OUTSIDE BACK

Outside backs are finished in vinyl matching the inside backs on single booths.

Options: Add outside finished backs to banquettes and long sides of circle corner booths (returns are finished, standard)

Materials: Wood, Laminate, Upholstery

### CORNER AND ROUND BOOTHS

Standard size circle corner booths shown below. Units are priced by the foot

#### Dimensions

Half Circle: 48" by 90" by 48"

Three-Quarter Circle: 48" by 48" by 90" by 48"

#### Corners

Standard: 90° or non-square, 23" inside back radius

Sharp: 90° or non-square, 90° inside and outside back

Inside Radius: Full circular inside back radius

Full Radius: Full circular inside or outside back radius



Shown with  
bar high base  
attached



# OPTIONS

## FURNITURE UPHOLSTERY TYPICAL

Our typical upholstery choices are JCM verified and tested. They meet or exceed commercial-grade standards. Note, "DR" refers to the industry standard , Wyzenbeek Double-Rub Abrasion test.



### GRADE 1\* VINYL

Keyston Jackson: 100,000 DR  
Culp Hathaway: 100,000 DR  
Culp Dillon: 200,000 DR  
Culp Linette: 100,000 DR / iClean™

### GRADE 2\* VINYL

Keyston Olympus Boltasport: 1,800,000 DR  
Nassimi Esprit: 200,000 DR  
Keyston Revolution: 400,000 DR  
Culp Rushmore: 200,000 DR

### GRADE 2\* UPHOLSTERY

Culp: Loose Change: 70,000 DR  
Culp Critics Choice: 30,000 DR  
Culp Fine Tune: 40,000 DR  
Culp Montgomery: 100,000 DR  
Culp Venue Fabric: 80,000 DR  
Culp Winslow: 40,000 DR  
Culp Petal Pusher: 40,000 DR

### GRADE 3\* UPHOLSTERY

Keyston Pebble: 200,000 DR  
Keyston Revolution: 400,000 DR  
Spradling Patriot Plus: 100,000 DR  
Spradling Whisper: 100,000 DR  
Douglass Smart Choice Fabric: DR

### COM

Customer Owned Material  
Contact JCM

**\*Grade is based on JustChair's purchase cost per yard and does not reflect upholstery quality or durability.**



# OPTIONS

## METAL & WOOD FINISH

Options below are standard metal seating finishes where indicated.

### POWDER COAT

Standard and BTO (see product pages)



Textured Black #16  
(standard)

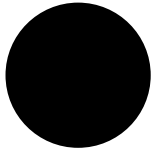

Gloss (smooth)  
Black #10



Silver Flash #00  
(glaze)

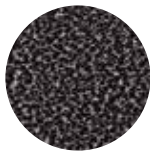

Silver Vein #11



Gold Vein #88



Copper Vein #07

### METALLIC

Standard and BTO (see product pages)

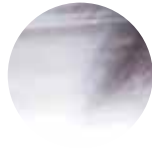

Clear-coat #00  
(industrial metal)



Silver/chrome #48  
(metallic)



Dark Gold #09



Metallic Gold #00

### BEECH WOOD FINISHES

Standard and BTO (QuickShip wood and Veneer Seats)



Natural



Cherry  
(Honey Oak  
on M668)



Dark  
Mahogany



Walnut

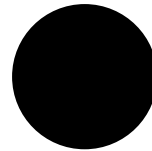

Black

### WOOD-LOOK FINISHES

Faux on Metal (not aluminum) Standard and BTO (see product pages)



Natural



Cherry



Mahogany



Walnut





# OPTIONS

## FURNITURE UPHOLSTERY TYPICAL

### GRADE 1: KEYSTON JACKSON VINYL

100,000 Double-Rub Resistance



### SPECIFICATIONS

Width 54 inch

Roll Size 30 yds

Weight 28 oz. per linear yard

Abrasion 100,000 Double Rubs

Cold Crack -10 degrees

UV Resistance 200 hrs

CAL117E-2013

UFAC Fabric, Class 1

Contract, Hospitality, Office,

Residential



# OPTIONS

## FURNITURE UPHOLSTERY TYPICAL

### GRADE 1: CULP DILLON VINYL

200,000 Double-Rub Resistance



### SPECIFICATIONS

100% Polyurethane

**Backing:** 70% Polyester;  
30% Cotton

**Finish:** Antimicrobial -  
Silver based ion technology

**Weight:** 20.3 oz. per linear yard

**Width:** 54"

**Environmental Benefit:**

PVC Free  
Phthalate - compliant CPSC sec. 108  
Lead com; CPSC sec. 101

**Abrasion:** Heavy Duty - Exceeds  
200,000 Cycles  
(Wyzenbeek - #8 Cotton Duck Abrad-  
ant)(ASTM D4157)

**Light Fastness:**

Class 4/100 hrs. min.  
(AATCC16A)

**Color Fastness:**

Class 5(ASTM D3597, AATCC 8)  
Wet & Dry

**Physical Properties:**

Class 5 (ASTM D3511) Brush Pill  
130 lbs. warp, 120 lbs. weft  
(ASTM D5034) Breaking Strength  
61 lbs. warp, 81 lbs. weft  
(ASTM D4034) Seam Slippage

**Passes:**

California Tech. Bulletin # 117-2013.  
UFAC Class 1  
NFPA 260 Class 1  
MVSS 302 Pass  
IMO A. 652(16) 8.2

**Cleanability:**

WS - Both water and solvent based  
solutions



103

Just Chairs and More! · 347.617.1317  
JustChair.com · Info@JustChair.com

# OPTIONS

## FURNITURE UPHOLSTERY TYPICAL

### GRADE 1: CULP LINETTE VINYL

100,000 Double-Rub Resistance



Enhanced zoom to show texture

### SPECIFICATIONS

100% Vinyl

**Backing:** 70% Polyester;  
30% Cotton

**Finish:** iClean™ stain resistant and moisture repellent, based on Nano Technology Antimicrobial

**Weight:** 40.19 oz. per linear yard

**Width:** 54"

**Abrasion:** Heavy Duty - Exceeds 100,000 Cycles (Wire screen Abradant) (ASTM D4157)

**Light Fastness:** Class 4/100 hrs. min (AATCC16A)

**Color Fastness:** Class 5 (ASTM D3597, AATCC 8) Wet & Dry

**Physical Properties:** Class 5 (ASTM D3511) Brush Pill 137 lbs. warp, 143 lbs. weft (ASTM D5034) Breaking Strength 88 lbs. warp, 94 lbs. weft (ASTM D4034) Seam Slippage 50,000 cycles (CFAA10) Flex Resistance

**Passes:** California Tech. Bulletin # 117-2013 UFAC Class 1 NFPA 260 Class 1 MVSS 302 Pass

**Cleanability:** WS - Both water and solvent based solutions Bleach cleanable - 5:1 Water/Bleach solution



# OPTIONS

## FURNITURE UPHOLSTERY TYPICAL

### SPECIFICATIONS

**Facing:** 100% PVC

**Backing:** 100% Spun Polyester  
Terry loop

**Weight:** 36oz. per linear yard

**Width:** 54"

**Abrasion:** Heavy Duty  
1,800,000 Cycles  
(#8 Cotton Duck)

**UV Resistance (QUV):**  
650 hrs.

**Color Fastness:**

Class 5 (ASTM D3597, AATCC 8)  
Wet & Dry

**Physical Properties:**

Class 5 (ASTM D3511) Brush Pill  
137 lbs. warp, 143 lbs. weft  
(ASTM D5034) Breaking Strength  
88 lbs. warp, 94 lbs. weft  
(ASTM D4034) Seam Slippage  
50,000 cycles (CFAA10) Flex Resistance

**Passes:**

California Tech. Bulletin # 117-2013  
UFAC Class 1  
NFPA 260 Class 1  
FMVSS 302 Pass  
IMO PART 8 (3.1 & 3.2)  
BIFMA X5.7-1991 SEC. 5.2.2 CLASS A  
May comply with Cal. 133 when tested with  
suitable components

### GRADE 2: OLYMPUS VINYL

1,800,000 Double-Rub Resistance





# OPTIONS

## FURNITURE UPHOLSTERY TYPICAL

### GRADE 2: OLYMPUS VINYL CONT...

1,800,000 Double-Rub Resistance



### CLEANING INSTRUCTIONS

Remove ordinary dirt and smudges with a mild soap and water solution and a clean, soft cloth or towel. Dry with a soft, lint-free cloth or towel.

**Caution:** *The use of upholstery "Conditioners" or "protectants" is not recommended and should be avoided on Olympus.*

Although Olympus is resistant to most common stains, the dyes and pigments in some staining agents have the ability to create a permanent stain if not treated properly. To clean difficult stains from Olympus, locate the staining agent in the lists below and follow the corresponding recommended cleaning method. For best results, treat all stains immediately

**Staining Agents:** Baby oil, ketchup, chocolate, motor oil, olive oil, grape juice, urine, blood, tea, coffee and beta dine - Use Method 1.

**Staining Agents:** Eye shadow, crayon, grease, tobacco tare (nicotine), permanent felt tip marker, yellow mustard, lipstick, ballpoint pen and spray paint - Use Method 1. If stain remains, use Method 2.

#### Method 1:

Use one of the following cleaners with a soft cloth or damp sponge. Rinse area with fresh water then dry with a clean, lint free cloth.

**Formula® 409 All-Purpose  
Spray Cleaner.**

**Fantastik® Spray Cleaner.**

#### Method 2:

Use a solvent-type cleaner, such as a rubbing alcohol (isopropyl alcohol). Rinse cleaned area with fresh water then dry with a clean, lint-free cloth. If the stain persists after six rubs, the stain has set and probably cannot be removed. Rinse cleaned area with fresh water, then dry with a clean lint-free cloth.





# OPTIONS

## CUSTOM & BUILT TO ORDER

JustChair offers unlimited customization options. Stock products will always be the fastest and most economical.



### FACTORY VS LOCAL CUSTOMIZATION

Factory customization (international production) costs much less than local customization (US production) of projects.

But factory customization requires a minimum of 16 weeks lead time, due to production lead time, sample approval and container shipment schedules.

Examples of factory customization, would be a physical change to wood chair frame, or complex refinishing.

Possible examples of Local Customization (LC), would be re-powder/color of a metal product, or reupholstery of an upholstered chair.

### CUSTOM WOOD FINISHES

Custom wood finishes can be produced on any built-to order product. Color matching fees do apply.

Typically, color matching will add 2 weeks to a project's lead time.

### FACTORY BUILT-TO-ORDER PRODUCTS

We do have factories and contract manufactures in the US and internationally.

Banquet seating, custom wood color tops or wood seating are all internationally built-to-order products with a Minimum of 12 week lead times.

Booths, Millwork, Laminate tops, DesignChoice™ tops, Werzalit tops and umbrellas are all US built-to-order products which require a Minimum of 4 week lead times.



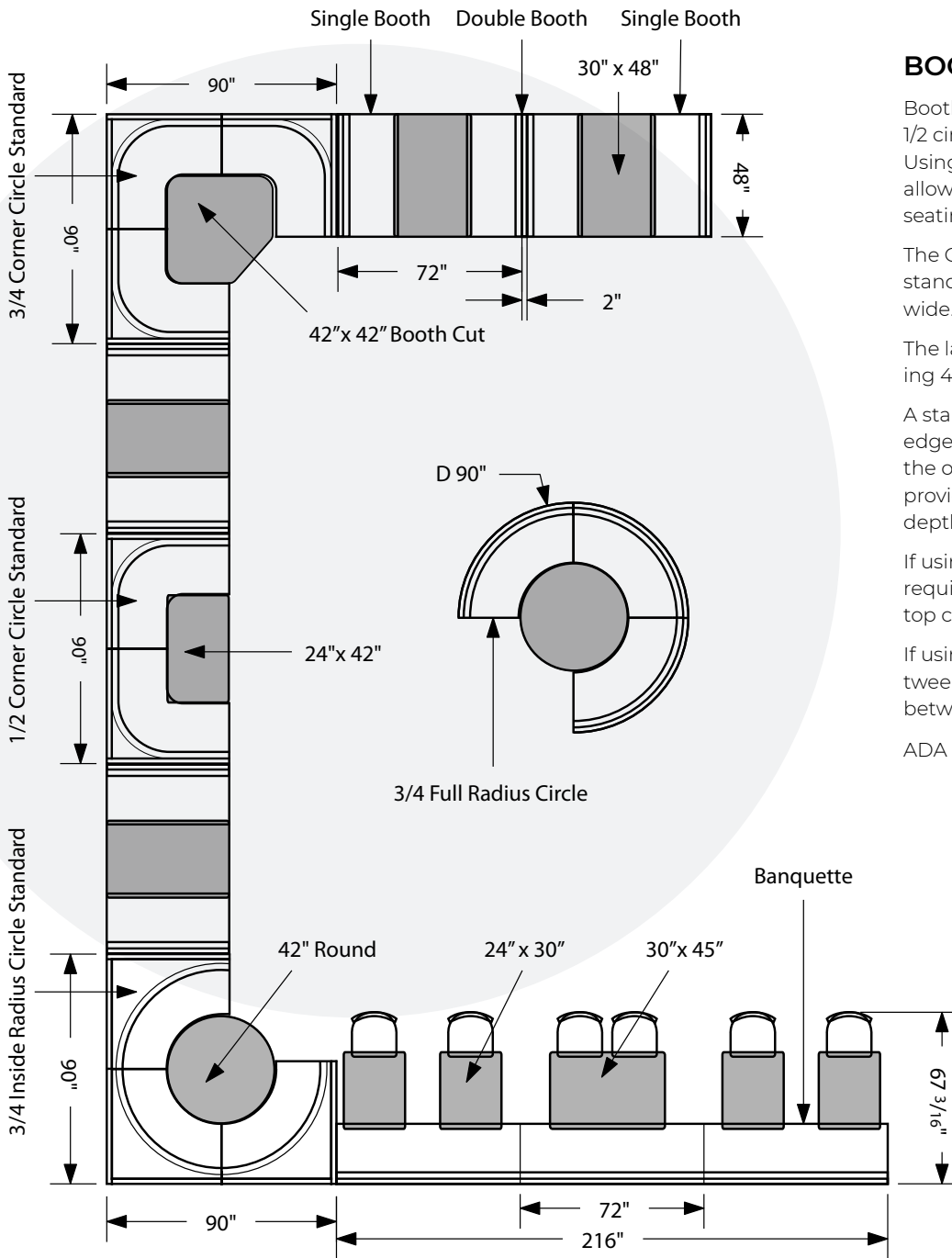

## BOOTH SPACING

Booths are available in single, double, 1/2 circle, 3/4 circle and wall benches. Using a wall bench with small tables allows easy conversion from couple seatings, to large parties.

The QuickShip top cap is 1.75". The standard and custom top cap is 1.75" wide.

The layout below, demonstrates using 46" long booths.

A standard layout allows the table edge to overlap by 1" vertically with the outer edge of the booth seat. This provides a comfortable 17-18" seating depth.

If using 30" wide tables, then booths require 72" from center to center of top caps.

If using 24" wide tables, the space between booths can be reduced to 66" between the center of top caps.

ADA requires a 36" wide table.

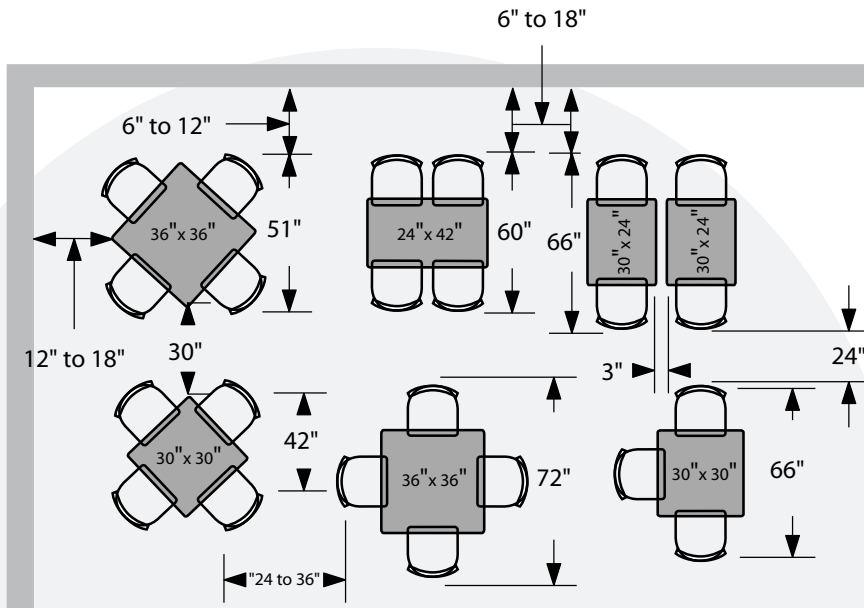

## AISLE WIDTHS

Wait staff aisles can be 24" to 30", with service/main aisles 36".

Recommended square inches per seat:

Banquet (close seating):  
96-120 sq/in per person.

Casual Dining:  
120-144 sq/in per person.

White Tablecloth (spacious seating):  
144-168 sq/in per person.

## TABLE SIZES

The architectural standard for dining suggests that 300 square inches of space be allowed per diner.

24" table width is a Minimum, suitable for a diner. 30" is the standard width.

Family dining with platters in the center should consider 36" widths.

Shading representing 10" plates is shown on the diagrams below.

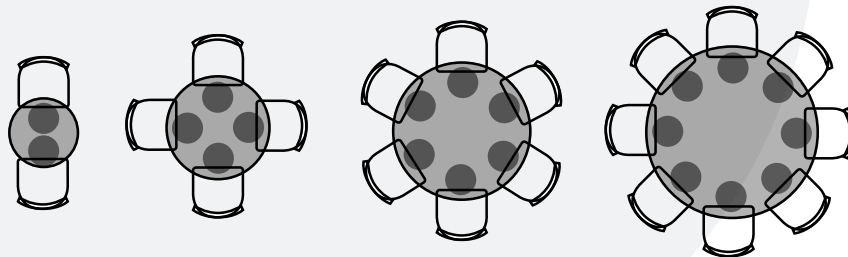

24" Round  
2 Seats

36" Round  
4 Seats

48" Round  
6 Seats

60" Round  
8 Seats

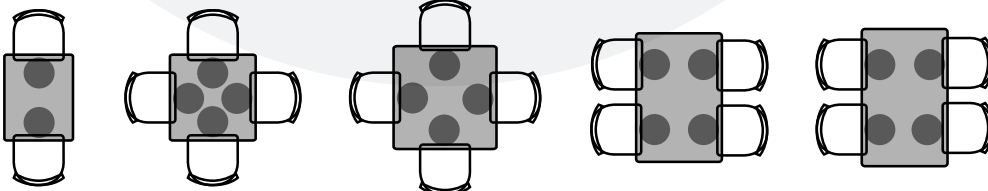

24"x30"  
2 Seats

30"x30"  
4 Seats

36"x36"  
4 Seats

30"x45"  
4 Seats

30"x48"  
4 Seats







# ABOUT

## UNDERSTANDING FREIGHT

Shipping furniture notes and information.

For freight quotes: e-mail [freight@justchair.com](mailto:freight@justchair.com)

### TYPES OF FREIGHT

**Small- Parcel / Ground:** Boxed items. Normally less than 24" x 24" x 40" to avoid oversize charges. Max ground size for example is 24" x 24" x 58".

**Medium- LTL:** Less than truckload, palletized freight, Minimum of 150 lbs. Ships from terminal to terminal, then is delivered via a local truck having multiple stops in the area. Normally Limited to 6 pallets or less.

**Large- FTL or Dedicated Truck:** Full truck load 26' or 53'. Items are not palletized. They will hand-stacked (floor loaded), loose or boxed.

### DELIVERY

**Small- Parcel / Ground:** Packages are picked up and delivered to the door of the receiver.

**Medium- LTL:** Less than truckload. These normally arrive at the discretion of the trucking company. 4 hour appointment windows can be arranged as an added service with an extra day of shipment time.

**Large- FTL or Dedicated Truck:** Full truck load. Items are not palletized. They are normally floor loaded (loose) or boxed.

**Unloading:** The truck driver is required to open the back of the truck only. The receiver is responsible for removing the items and packaging from the truck within an hour of arrival.

**Special services (additional charges):** Limited delivery sites, gated areas, lift-gates, unloading, inside delivery, extended wait time, installation, to name a few.

### THINGS TO CONSIDER FOR LTL/FTL/ DEDICATED TRUCK:

**Unloading:** Have plenty of help for unloading. Normally two people in the truck and two people accepting the furniture then walking it in. Note that for most furniture, it is easier to hand off at truck height, than using a lift-gate.

**Inspection and damage: NEVER refuse.** It can delay replacements or repairs for weeks as the freight company tries to reroute. Always photograph and notate any visible damage on the bill of lading when you sign.

**Concealed damage:** The driver is not responsible to wait for inspection inside the packaging. Please provide descriptive photographs and e-mail your sales rep as soon as discovered.

**Repairs and replacements:** Furniture is often built-to-order and highly modular. Many of the damaged components can be quickly replaced without complete remanufacture of the entire unit.





# 9 STEPS TO BUILDING QUALITY

Certified 40 Year German beech wood, is tough and consistent

1



2 Fabricated with computer precision for a perfect fit



3 Craftsman tongue & groove, factory glued for stability



4 Custom hardened steel anchors prevents wobbles



Automated poly finish for perfect color

5

From start to finish, JCM provides the absolute best. And we back it with our **5 Year Warranty.**



Quality Standards ISO 9001, 18001, 4001 certified and InterTek™ test factory

8

Nationwide and Local sales & support network. Delivers local support before and after the sale



7 100% wrapping ensures against damage

6

Double layer seat foam for double the comfort



New York Billing Office  
59-71 59th Street  
Maspeth, NY 11378  
Sales@JustChair.com

Atlanta Assembly Plant:  
5390 E Ponce de Leon Ave, Ste. D  
Stone Mountain, GA 30083  
O 347-617-1317, F 347-507-0604

Toccoa Fabrication Factory:  
890 Elberton St.  
Toccoa, GA 30577  
website: www.JustChair.com